



SCANIA

LÍNEA PESADA

Catálogo de productos



- Repuestos de inyección diesel.
- Bombas de combustible.
- Filtros trampa de agua.
- Toberas elementos y válvulas.
- Inyectores.
- Sensores.
- Tensores.
- Mangueras de intercooler.
- Turbos Sobrealimentadores.
- Cajas y flexibles levanta cabina.
- Tuberías rígidas y flexibles.





INDICE

INDICE CON LINEAS DE PRODUCTOS PARA CATÁLOGOS POR MARCAS DE VEHÍCULOS

1- Repuestos, Accesorios y Despiece para Inyección Diesel.

- Abrazaderas
- Anillos de Goma
- Arandelas
- Bombas Alimentadoras
- Bulones Perforados
- Mangueras Universales
- Cebadores
- Electroválvulas
- Filtros
- Juegos de Juntas
- Líquido aditivo Diesel Power
- Prefiltros
- Seguros para Caños de Inyección
- Uniones Orientables
- Válvulas
- Vasos

2- Toberas, elementos y válvulas "DMB" y toberas Common Rail e inyectores

3- Bujías Incandescentes "DMB".

4- Common Rail.

5- Tensores de correa.

6- Turbos "DMB"

7- Tuberías Flexibles y rígidas.

- Para Inyección
- Para Combustible
- Para Aceite
- Para Dirección Hidráulica
- Para Accionamiento de Embrague
- Para Freno Hidráulico
- Para Conducción de Agua y Aire
- Para Aire Comprimido



Guia explicativa uso de catalogo productos CMD.

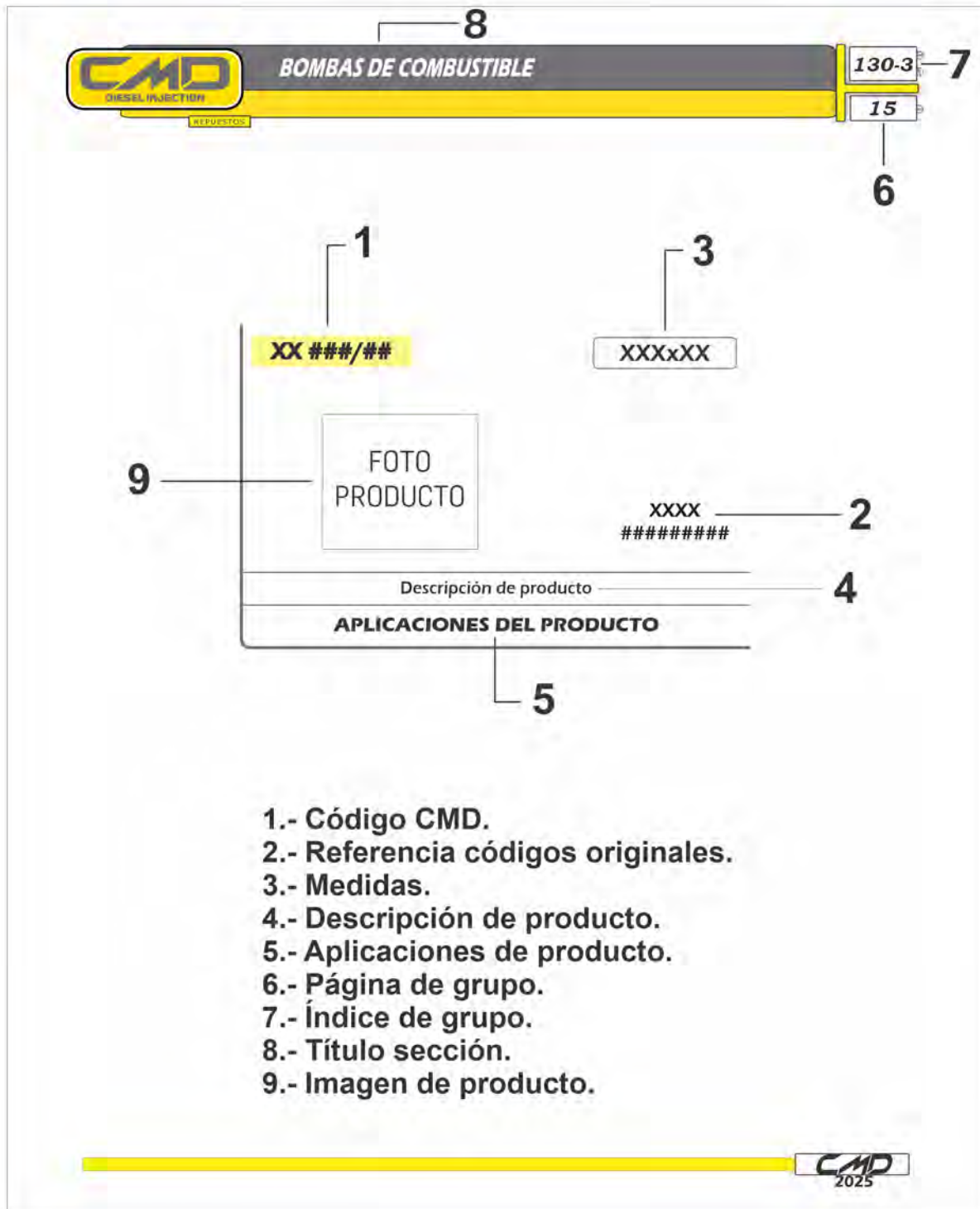

- 1.- Código CMD.
- 2.- Referencia códigos originales.
- 3.- Medidas.
- 4.- Descripción de producto.
- 5.- Aplicaciones de producto.
- 6.- Página de grupo.
- 7.- Índice de grupo.
- 8.- Título sección.
- 9.- Imagen de producto.

Las Marcas y Logos® que aparecen en los catalogos CMD pertenecen a sus respectivos dueños, y cuando son mencionadas estan a titulo informativo.

L	A	C	G	D	d	K	Cono	Cod. CMD
50	90°	16	16	74	37	3	A	AE 102/1
50	90°	19	16	74	37	4	B	AE 102/2
85	90°	16	16	74	37	3	A	AE 102/3
77		16	16	74	37	3	A	AE 102/4
51	90°	19	17	85	37	4	B	AE 102/6
52	90°	19	23	74	37	4	B	AE 102/9
43	*	20	16	105	*	4	CIL	AE 102/10
*	*	20	20	74	*	4,7	B	AE 102/12
68	90°	19	20	90	37	4	B	AE 102/13
*	*	20	31	99	*	4,7	CIL	AE 102/14
80	*	21	16	85	*	*	*	AE 102/15
70		16	23	74	37	3	A	AE 102/16
50	90°	19	20	90	37	4	B	AE 102/18
*	*	*	20	74	*	4,7	CIL	AE 102/19
50	90°	19	20	90	37	4	B	AE 102/20
*	*	20	*	105	*	4	*	AE 102/21
*	*	20	*	105	*	4	CIL	AE 102/22

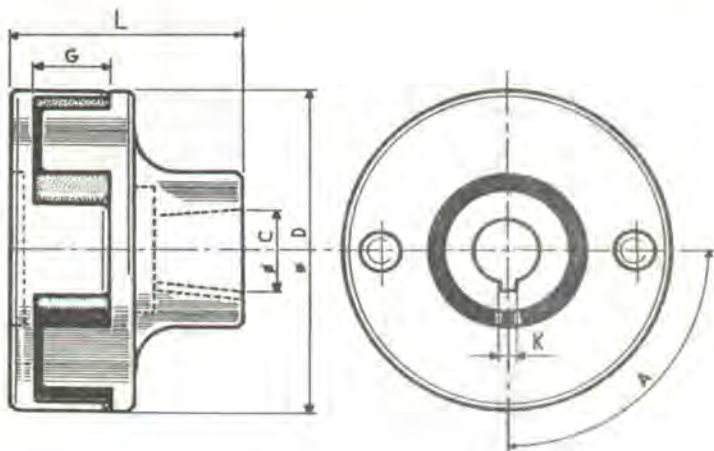

AE 102/6



SCANIA VABIS

AE 102/7



SCANIA VABIS 150

AE 102/13



SCANIA VABIS

AG 103/2



Acople de Goma Sintetica

SCANIA

AG 103/7



Acople de Goma Sintetica

SCANIA VABIS

AG 103/12



Acople de Goma Sintetica

SCANIA 111 / 112

AH 104/1



Plana

SCANIA VABIS

AH 104/5



Arandela buje

SCANIA VABIS

AH 104/7



Scania
192641

Para bomba "P" Arandela buje

SCANIA VABIS 111

REPUESTOS

AH 104/8



Plana

SCANIA 111

AH 104/10



280868

Arandela buje

SCANIA 112

AH 104/11



280869

Arandela plana

SCANIA 112

AH 104/12



306703

Arandela buje para lámina ondulada

SCANIA 113

AH 104/13



306704

Arandela plana para lámina ondulada

SCANIA 113

REPUESTOS

AG 105/1

6 mm



Bosch

2 916 699 083
2 916 693 005
2 916 690 005
2 916 698 053
2 916 699 132

Arandela grower

VS

AG 105/2

8 mm



Arandela grower

VS

AG 105/3

10 mm



Arandela grower

VS

AG 105/4

1/2 "



Arandela grower

VS

AG 105/5

9/16"



Arandela grower

VS

AG 105/6

16 mm



Arandela grower

VS

AG 105/7

6 mm



Lucas
9007-200R

Arandela grower para bomba DPC

VS

AG 105/8

18 mm



Bosch
2 916 693 012

Arandela grower para bomba P

VS

AG 105/9

20 mm



Bosch
2 916 693 013

Arandela grower para bomba P

VS

REPUESTOS

AG 105/10

14 mm



Arandela grower

VS
AG 105/11

12 x 17 mm

Bosch
1 420 151 001

Arandela grower de Regulador RSV

VS
AG 105/12

1"

Bosch
2 916 699 093

Arandela grower para bomba tipo P

VS

REPUESTOS

CÓDIGO	MEDIDA (mm)		CÓDIGO	MEDIDA (mm)	
AL 105/1	4 x 9 x 1.25		AL 105/15A	19 x 23 x 1.25	
AL 105/2	5 x 9 x 1.25		AL 105/15B	18 x 25 x 1.25	
AL 105/2A	5 x 13 x 1.25		AL 105/16	20 x 26 x 1.25	
AL 105/3	6 x 10 x 1.25		AL 105/17	22 x 28 x 1.25	
AL 105/3A	7 x 10 x 1.25		AL 105/18	24 x 30 x 1.25	
AL 105/3B	7 x 14 x 1.25		AL 105/19	26 x 32 x 1.25	
AL 105/3C	7 x 14 x 2		AL 105/20	28 x 36 x 1.25	
AL 105/4	8 x 13 x 1.25		AL 105/21	30 x 36 x 1.25	
AL 105/5	8 x 12x 1 (doble)		AL 105/22	32 x 40 x 1.25	
AL 105/6	9 x 14.5 x 1.25		AL 105/23	34 x 42 x 1.25	
AL 105/7	10 x 14.5 x 1.25		AL 105/23A	35 x 41 x 1.25	
AL 105/8	11 x 17 x 1.25		AL 105/24	36 x 42 x 1.25	
AL 105/9	12 x 17 x 1.25		AL 105/25	38 x 46 x 1.25	
AL 105/10	13 x 20 x 1.25		AL 105/25A	39.5 x 53 x 0.5	
AL 105/11	14 x 20 x 1.25		AL 105/26	41 x 45 x 1.25	
AL 105/11A	14 x 23 x 1.25		AL 105/26A	41 x 55 x 1.25	
AL 105/12	15 x 21 x 1.25		AL 105/26B	41 x 55 x 0.5	
AL 105/13	16 x 21 x 1.25		AL 105/27	42 x 49 x 1.25	
AL 105/13A	16 x 24 x 1.25		AL 105/28	44 x 52 x 1.25	
AL 105/14	17 x 22 x 1.25		AL 105/29	46 x 54 x 1.25	
AL 105/15	18 x 23 x 1.25		AL 105/30	52 x 60 x 1.25	

REPUESTOS

CÓDIGO	MEDIDA (mm)
CO 105/1	4 x 9 x 1.25
CO 105/2	5 x 9 x 1.25
CO 105/3	6 x 10 x 1.25
CO 105/3A	6 x 10 x 1 (doble)
CO 105/3B	7 x 14 x 1.25
CO 105/4	8 x 12.5 x 1.25
CO 105/4A	8 x 11 x 1.25
CO 105/5	8 x 12 x 1 (doble)
CO 105/6	9 x 14.5 x 1.25
CO 105/7	10 x 14 x 1.25
CO 105/8	11 x 17 x 1.25
CO 105/9	12 x 17 x 1.25
CO 105/10	13 x 20 x 1.25
CO 105/11	14 x 20 x 1.25
CO 105/11A	14 x 23 x 1.25
CO 105/12	15 x 21 x 1.25
CO 105/13	16 x 21 x 1.25
CO 105/13A	16 x 24 x 1.25
CO 105/14	17 x 22 x 1.25
CO 105/15	18 x 23 x 1.25
CO 105/16	20 x 26 x 1.25
CO 105/17	22 x 26 x 1.25
CO 105/18	24 x 30 x 1.25
CO 105/19	26 x 32 x 1.25
CO 105/20	28 x 36 x 1.25
CO 105/21	30 x 36 x 1.25
CO 105/22	32 x 40 x 1.25
CO 105/23	34 x 42 x 1.25
CO 105/24	36 x 42 x 1.25

CÓDIGO	MEDIDA (mm)
CO 105/25	38 x 46 x 1.25
CO 105/26	41 x 45 x 1.25
CO 105/27	42 x 49 x 1.25
CO 105/28	44 x 52 x 1.25
CO 105/29	46 x 54 x 1.25
CO 105/30	52 x 60 x 1.25

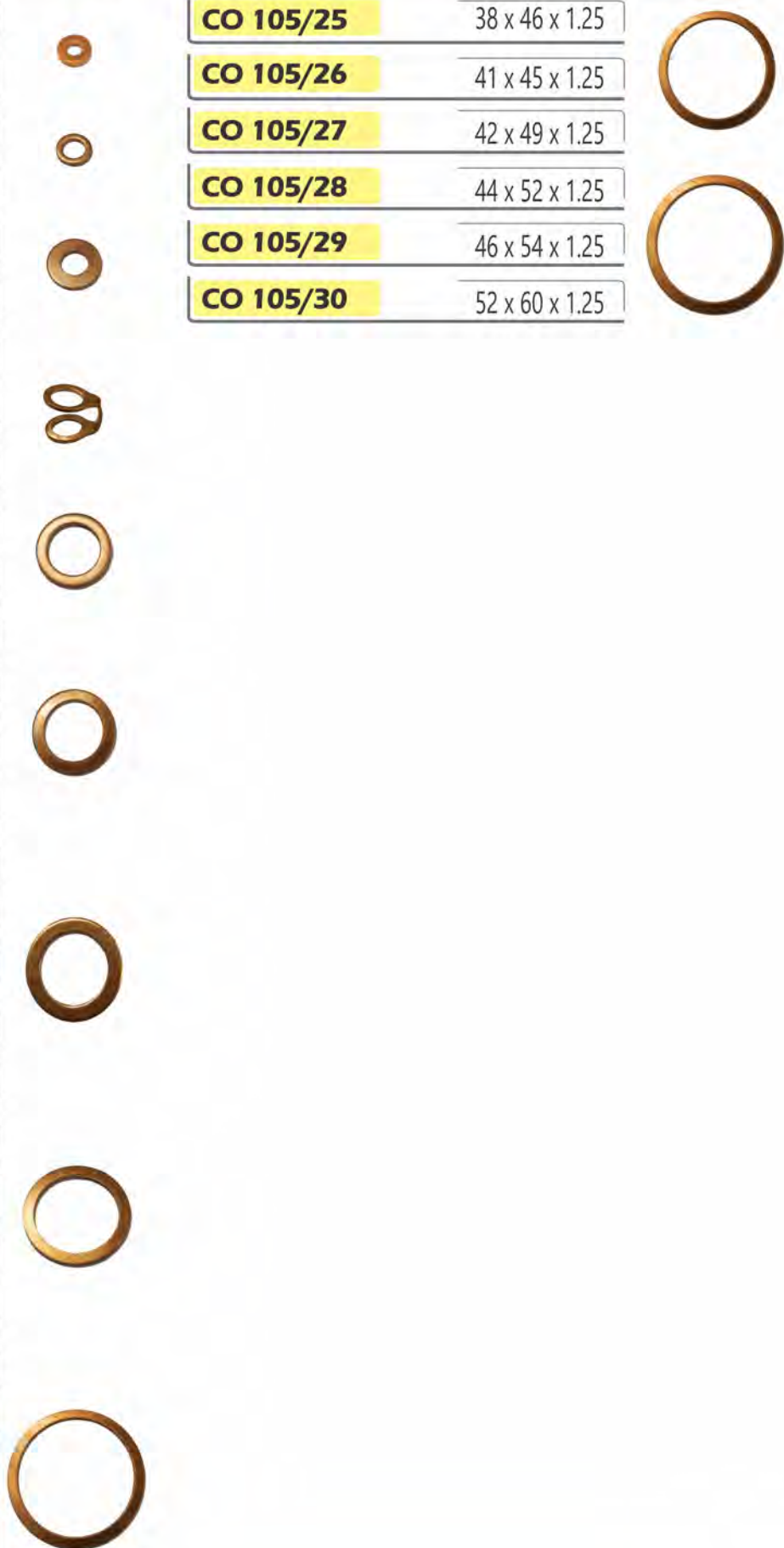

REPUESTOS

CÓDIGO	MEDIDA (mm)
FI 105/2	5 x 9 x 1.5
FI 105/2A	5 x 12 x 1.5
FI 105/3	6 x 10 x 1.5
FI 105/3A	6.5 x 12.5 x 1.5
FI 105/4	8 x 13 x 1.5
FI 105/6	9 x 14.5 x 1.5
FI 105/7	10 x 14 x 1.5
FI 105/8	11 x 17 x 1.5
FI 105/9	12 x 17 x 1.5
FI 105/10	13 x 20 x 1.5
FI 105/10A	13 x 24 x 1.5
FI 105/11	14 x 20 x 1.5
FI 105/12	15 x 21 x 1.5
FI 105/13	16 x 21 x 1.5
FI 105/13A	16 x 24 x 1.5
FI 105/14	17 x 22 x 1.5
FI 105/15	18 x 23 x 1.5
FI 105/16	20 x 26 x 1.5
FI 105/17	22 x 28 x 1.5
FI 105/18	24 x 30 x 1.5
FI 105/19	26 x 32 x 1.5
FI 105/20	28 x 36 x 1.5
FI 105/21	30 x 36 x 1.5
FI 105/22	32 x 40 x 1.5
FI 105/23	34 x 42 x 1.5
FI 105/24	36 x 42 x 1.5
FI 105/25	38 x 46 x 1.5
FI 105/26	41 x 45 x 1.5
FI 105/27	42 x 49 x 1.5

CÓDIGO	MEDIDA (mm)
FI 105/28	44 x 52 x 1.5
FI 105/29	46 x 54 x 1.5
FI 105/30	52 x 60 x 1.5



REPUESTOS

AC 112/6

9 x 15.5 x 2 mm



De cobre

SCANIA 113

AC 112/17

10 x 25 x 2 mm



De cobre

SCANIA VABIS

AC 112/18

10 x 19 x 2 mm



De cobre

SCANIA

Perkins
920113

AC 112/18A

10 x 19 x 1.5 mm



De cobre

SCANIA

AC 112/24

9.1 x 19 x 2 mm



De cobre

SCANIA K-112

REPUESTOS

AV 114/9



De cobre para válvula de bomba inyectora

SCANIA VABIS

AV 114/21



De bronce

SCANIA 112

Bosch

2 410 105 005
2 410 101 009

AV 114/21A



Entre válvula racord

SCANIA

Bosch

2 410 105 003

AV 114/26



Bosch
2 410 029 001

De acero con pestaña para válvula de bomba P 700

SCANIA 112

AV 114/27



Bosch
2 410 005 003

De acero plana para válvula de bomba P700

SCANIA 112

REPUESTOS

AC 115/1

25.5 x 29.5 x 1.2

Bosch
2 440 105 000
Fiat
760 241

De cobre para tapón bomba alimentadora tipo Bosch

VS
AC 115/2

16 x 19

Bosch
1 230 203 001

Para cebador y tapón chico bomba alim. tipo Bosch

VS
AC 115/505

Cummins
4307148

Arandela para inyector HPI

SCANIA DC12/DT12 CUMMINS ISX/QSX
AC 115/506

Arandela de cobre externa de asiento de inyector

SCANIA DC12/DT12 CUMMINS ISX/QSX

REPUESTOS

AC 116/7

4 x 10 x 2.6



Arandela de cobre cónica para caño inyección espesor 0.50

VS
AC 116/8

4 x 10 x 2.6



Arandela de cobre cónica para caño inyección espesor 0.90

VS

REPUESTOS

	Pulgadas		Milímetros	
	Ø min	Ø max	Ø min	Ø max
AB 117/1	5/16	3/8	8	10
AB 117/2	3/8	1/2	10	12
AB 117/2A	7/16	17/32	11	11.5
AB 117/3	1/2	9/16	12	14
AB 117/4	9/16	5/8	14	16.5
AB 117/5	11/16	3/4	17	19.5



Fleje ancho 9 mm - Espesor 0.5 mm

COMPACTA

REPUESTOS

	Pulgadas		Milímetros	
	Ø min	Ø max	Ø min	Ø max
AB 117/6	5/16	5/8	8	16
AB 117/7	3/8	13/16	10	20
AB 117/7A	1/2	1	12	26
AB 117/8	3/4	1 1/4	20	32
AB 117/9	1 1/4	1 3/4	30	45
AB 117/10	1 9/16	2 1/8	40	55
AB 117/11	2	2 9/16	50	65
AB 117/12	2 3/8	3	60	75

	Pulgadas		Milímetros	
	Ø min	Ø max	Ø min	Ø max
AB 117/13	2 3/4	3 3/8	70	85
AB 117/14	3 1/8	3 3/4	80	95
AB 117/15	3 1/2	4 1/8	90	105
AB 117/16	3 5/16	4 1/2	100	115
AB 117/17	4 5/16	4 15/16	110	125
AB 117/18	5 1/8	5 11/16	130	145



Fleje ancho 8.5 mm - Espesor 0.8 mm

MINI SUPER

	Pulgadas		Milímetros	
	Ø min	Ø max	Ø min	Ø max
AB 117/19	1 3/8	1 3/4	35	45
AB 117/20	1 9/16	2 1/8	40	55
AB 117/22	2 3/8	3	60	75
AB 117/23	2 3/4	3 3/8	70	85
AB 117/24	3 1/8	3 3/4	80	95
AB 117/25	3 1/2	4 1/4	90	105
AB 117/26	3 3/8	4 1/2	100	115

	Pulgadas		Milímetros	
	Ø min	Ø max	Ø min	Ø max
AB 117/27	4 5/16	4 15/16	110	125
AB 117/27A	4 3/4	5 3/8	120	135



Fleje ancho 14.4 mm - Espesor 0.8 mm

SUPER CIERRE RAPIDO

	Pulgadas		Milímetros	
	Ø min	Ø max	Ø min	Ø max
AB 117/29	9/16	3/4	14	20
AB 117/30	5/8	7/8	16	22
AB 117/31	3/4	1 1/8	20	28
AB 117/32	1	1 3/8	25	35
AB 117/33	1 3/16	1 9/16	30	40
AB 117/34	1 3/8	1 3/4	35	45
AB 117/34A	1 1/2	2	38	50
AB 117/35	1 9/16	2 1/8	40	55
AB 117/36	1 3/4	2 3/8	45	60

	Pulgadas		Milímetros	
	Ø min	Ø max	Ø min	Ø max
AB 117/37	2	2 5/8	50	65
AB 117/38	2 3/8	3	60	75
AB 117/39	2 3/4	3 3/8	70	85
AB 117/40	3 1/8	3 3/4	80	95
AB 117/41	3 1/2	4 1/8	90	105
AB 117/42	3 15/16	4 1/5	100	115
AB 117/43	4 5/16	4 15/16	110	125
AB 117/44	5 1/8	5 11/16	130	145



Fleje ancho 14.4 mm - Espesor 0.8 mm

TIPO AMERICANA

	Pulgadas		Milímetros	
	Ø min	Ø max	Ø min	Ø max
AB 117/90	1/4	5/8	6	16
AB 117/91	7/16	13/16	11	20
AB 117/92	1/2	15/16	13	24



Fleje ancho 8 mm - Espesor 0.5 mm

REPUESTOS

	Pulgadas	
	Ø min	Ø max
AB 117/45	9	11
AB 117/46	11	13
AB 117/47	13	15
AB 117/48	15	17
AB 117/49	17	19
AB 117/50	19	21
AB 117/51	21	23
AB 117/52	23	25
AB 117/53	25	27
AB 117/54	27	29
AB 117/55	29	31
AB 117/56	31	33
AB 117/57	33	35
AB 117/58	35	37
AB 117/59	37	41
AB 117/60	41	44
AB 117/61	44	47
AB 117/62	47	50
AB 117/63	50	54
AB 117/64	54	58
AB 117/65	58	62
AB 117/66	62	66



**SOPORTAN ALTAS PRESIONES, REUTILIZABLES, CIERRE PERFECTO.
SOPORTAN ALTAS TEMPERATURAS, ANTICORROSIVAS, ATÓXICAS.
ECONOMÍA DE COSTO, FACILIDAD DE COLOCACIÓN.**

PI 161/101



Para abrazaderas plásticas

VS

REPUESTOS

AG 122/79



Bosch
1 900 210 105

Para eje de pare de TPS

SCANIA

AG 122/85



Bosch
2 440 210 019

Para racord reductor RAC 173/35 - tapón c/válvula

VS

AG 122/86



Bosch
1 480 210 016

Para racord entrada de bbta. De llenado de circuito

VS

REPUESTOS

AG 122/96



Bosch
2 440 210 010

Para racord tapón con válvula tipo M

SCANIA

AG 122/97



Bosch
1 900 210 119
2 440 210 013

Para racord tapón con válvula tipo M

VS

AG 122/98



Bosch
2 440 210 012

Para racord tapón con válvula tipo M

SCANIA

AG 122/99



Bosch
2 430 210 027

Para inyector

SCANIA 113

AG 122/202



Bosch
1 410 210 014

Vitón inferior elemento bomba P

SCANIA

AG 122/206



Bosch
2 410 210 049

Vitón elemento bomba P

SCANIA 113

AG 122/207



Bosch
2 410 210 033

Vitón Racord porta válvula bomba P

SCANIA 112 /113 DEUTZ

AG 122/208



Bosch
2 410 210 013

Nitrilo porta ruleman bomba P

SCANIA

AG 122/209



Bosch
2 410 206 003

Para tapa inferior cuadrado 8 cilindros

SCANIA

AG 122/210

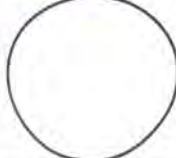

Bosch
2 410 206 005

Para tapa inferior cuadrado 6 cilindros

SCANIA

AG 122/211



Bosch
2 410 210 065

Nitrilo porta ruleman bomba P

SCANIA 113

AG 122/212



Bosch
2 410 210 034

Vitón superior elemento bomba P

SCANIA 112 STANDARD

AG 122/300



Bosch
2 430 206 004

Vitón para inyector

SCANIA 112 STANDART

AG 122/301



Scania
249 928

Vitón para inyector - plano inyector roscado

SCANIA 112 STANDART

AG 122/302



Scania
308 399

Viton para inyector (copita)

SCANIA 112 STANDART

AG 122/310



Para inyector

SCANIA 124 SERIE 4 (MECÁNICO)

AG 122/600



Para inyector de bomba sistema PDE - de vitón

SCANIA SERIE 4

AG 122/601



Para inyector de bomba sistema PDE - de vitón

SCANIA SERIE 4

REPUESTOS

AG 122/602



Para inyector de bomba sistema PDE - de vitón

SCANIA SERIE 4

REPUESTOS

BA 127/6



Cabeza frezada

SCANIA VABIS

BP 129/1

8 x 1 x 17 mm



Bosch
2911235700
2433456035
Lucas / Delphi
7169-60
Deutz
300-1744
111-9231
992-8367

Para descarga de inyector

SCANIA

BP 129/6

8 x 1 mm



Deutz
121-6492

Doble, para unión descarga

SCANIA

BP 129/7

6 x 1 x 15 mm



Bosch
2433314120
2433314256
Cummins
3905307

Para descarga de inyector

SCANIA

BP 129/9

10 x 1 mm



Bosch
2 911 201 701

Varias aplicaciones

SCANIA

BP 129/16

14 x 1.5 mm



Bosch
2 911 201 703
Fiat
705737
Deutz
111-9243

Varias aplicaciones

SCANIA

BP 129/17

14 x 1.5 mm



Deutz
121-6493
Iveco
1570211

Varias aplicaciones

SCANIA

BP 129/18

14 mm



Bosch
2 443 456 018
Zexel
152300-0920

Para filtro interior (sin filtro)

SCANIA

BP 129/18A

14 x 1,5 mm



Bosch
2 443 456 018
Zexel
152300-0920

Para filtro interior

SCANIA

BP 129/19

14 mm



Bosch
2 911 205 703
Fiat
763 153

Para prefiltro

SCANIA

BP 129/20

16 x 1.5 mm



Bosch
2 911 201 705

Aplicaciones varias

SCANIA

BP 129/21

18 mm



Fiat
746 991

Aplicaciones varias

SCANIA

REPUESTOS

BP 129/22

20 mm



Aplicaciones varias

SCANIA

BP 129/23

22 x 1.5



Aplicaciones varias

SCANIA

BP 129/24

24mm



Aplicaciones varias

SCANIA

REPUESTOS

BA 130/11



Bosch
0440011007

Bombita de llenado de circuito

SCANIA

BA 130/11A



Bosch
0440011009

Bombita de llenado de circuito

SCANIA

BA 130/11H



Bosch
0440011010

Bombita de llenado de circuito con cebador de hierro y con resorte

SCANIA

BA 130/12



Bosch
0440011011

Bombita de llenado de circuito con pre-filtro

SCANIA

BA 130/13



Bosch
42023436

Bombita de llenado de circuito con prolongador CD 139/19

SCANIA

BA 130/24



Bosch	KHD	Volvo
0 440 008 007 - FP/K 22 P9	0768702	1699140
0 440 008 998 - FP/K 22 P22	12034285	243083
0 440 008 029 - FP/K 22 P31	12038254	240072
0 440 008 037 - FP/K 22 P39	1173764	244391
0 440 008 045 - FP/K 22 P46	9981532	7243083
0 440 008 048 - FP/K 22 P51	4140419	Scania
0 440 008 020 - FP/K 22 P22		Fiat Allie
0 440 008 052 - FP/K 22 P58	71105310	319789
0 440 008 993 - FP/K 22 P58	768702	211005
0 440 008 004 - FP/K 22 P6	74061644	243083
		Magirus Deutz
Mercedes Benz		
001 091 67 01	75204008	9981532
000 090 05 50	79026637	7981171
001 091 78 01...	9981532	

Bomba alimentadora para bomba T/P sin filtro

SCANIA 111/112/113

BA 130/24P

E/S M14 X 1.5



Bosch
0 440 008 004 FP/K22P6
0 440 008 048 FP/K22P51
Mack (USA)
9350440008004
Scania
523 260
Volvo
240072

Ref. BCD
5008 5004

Bombita alimentadora para bomba T/P con pre-filtro

SCANIA 111/112

BA 130/25



Bosch
0 440 008 003
0 440 008 999 FP/K22P5
0 440 008 014 FP/K22P5
0 440 008 035
0 440 008 046
0 440 008 017 FP/K22P19
0 440 008 033 FP/K22P15
0 440 008 040 FP/K22P42
Mercedes Benz
001 091 61 01
001 091 25 01
000 090 03 50
Iveco
750696
93159106
DAF
2420070
12A6809

1/4" x 18 NPTF

Renault (RV)	KHD
500058510	1260836
5001832885	1262033
Magirus Deutz	1287495
0759596	1261133

Bombita alimentadora para bomba T/P con pre-filtro

SCANIA 111

BA 130/26



Bosch
0440008068
Volvo
244825
3830076
Iveco
71445067
8092471
Scania
1307770
KHD
4188108

Pin 024-11,5mm

FP/KG 24 P 200

Bombita alimentadora con cuerpo de aluminio

SCANIA 112 / 113 (200 Y 250 HP)

BA 130/27



Bosch
0440008108 FP/KG 24P 311

Bombita alimentadora con cuerpo de aluminio

SCANIA 113 - BOMBA 7100

BA 130/36



Bosch
0 440 001 006
0 440 001 007
0 440 001 022
Mercedes Benz
000 091 65 01
Volvo
2382222-77988
MWM
60520204003
MAN
1121508002
Iveco
9922392

KHD

1287462

8122245

1287463

Hanomag

197942706

506686000

Renault

0025838017

0003020500

0854310800

FP/K 22 BC 47

FP/K 22 BC 47/2

FP/K 22 BC 135

Bomba alimentadora para bomba T/B sin filtro

SCANIA

BA 130/36P



Bosch
0 440 001 009 FP/K22BC48
0 440 001 037 FP/K22BC161
0 440 001 038 FP/K22BC175
0 440 001 074 FP/K22BC236/2
Mercedes Benz
0000911601
0000918001
KHD/Deutz
01287466
01298719
01301806

M14x1.5

Volvo

2380098

Renault (RV)

7701009567

Iveco

742676

Saurer

1130843402

Faun

0794616

Ref. BCD
5001-5009

Bomba alimentadora para bomba T/B con pre-filtro

SCANIA 111/112

REPUESTOS

BA 130/47



Bosch
0440008089
0440008198
Volvo
863474
Scania
1307770
Man
51121017121
DAF
1339048

Pin 028-13,5mm

FP/KG 24 P 307

Bomba alimentadora

SCANIA 124

BA 130/54V



Bosch
0 440 008 008
0 440 008 077
0 440 008 090
0 440 008 114
0 440 008 116
MWM
605202030033
Scania
1123841

M14x1.5

FP/KD 22 P80 - 80I
P89 - P90 - P10 - P85

Bomba alimentadora de cuatro válvulas

SCANIA

BA 130/55V



Bosch
0 440 008 015
0 440 008 009
Iveco
7681171
Scania
211005-319789
Mercedes Benz
001 091 67 01
000 090 05 50
FP/K 22 P 17
FP/K 22 P 11

Bomba alimentadora

SCANIA

BA 130/56V



Bosch
0 440 008 005
0 440 008 028
0 440 008 031
0 440 008 039
0 440 008 053
0 440 008 118
0 440 008 996
FP/KD 22 P30 - P33
P41 - P59 - P91 -
P8 - P32

Roscas Entrada y salida:
14 X 1,5

Zexel
105237-4180

Bomba alimentadora

SCANIA

BA 130/61



Bosch
9440037000
9440030018
Scania
347102
KHD
0170173910
1261132

Steyr
81560080036

FP/KD 22 P24
FP/KD 22 P52-1

Bomba alimentadora de cuatro válvulas

SCANIA - KHD - STEYR

BA 130/62



Bosch
0440008113
0440008137
Scania
1422627
1744064
Cummins
3092731

PIN 028 - 13,5mm
M14x1,5

Ref.BCD
52081113

Bomba alimentadora

SCANIA 9.0L ESTACIONARIOS
S4DC/DSC9/11.0L

BA 130/63



Bosch
0440008092
Man
51121017075
51121017107
FP/GK 24 P 210

PIN 024-11,5mm

Bomba alimentadora

MAN - SCANIA

BA 130/64



Bosch
0440008084
Man
51121017081
51121017106
FP/KG 24 P304

PIN 028-13,5mm

Bomba alimentadora

MAN - SCANIA

BA 130/93



Bosch
0440 020 057
0440 020 128
Scania
1539298

Bomba alimentadora

SCANIA SERIE 4 - SERIE P/G/R/T

BA 130/96



Bosch
0440020129
0440020058
0440020010
FP/ZP17H/R1S
Scania
1536255

Bomba alimentadora

SCANIA DC16 - 15.0L / 16.0L

REPUESTOS

BA 130/209



Scania
1518142 , 804670 , 2081828
1430067 , 1373793 , 1440235
1852161 , 813198 , 1737657
1745730 , 1731092 , 1514998
760709 , 1760708 , 809809
809820 , 802998
MAN
51471040024

Bomba de combustible

SCANIA P/G/R/T BUS 4- / F- / F- SRIES
MOTOR DC12

BA 130/216



Scania
2059884
2477223

Bomba de combustible

SCANIA MOTOR DC13

BA 130/219



Scania
3063789
P4384252

Bomba alimentadora de combustible de baja DMB
para 2836838 2478832

SCANIA SERIE L/P/G/R/S DC13

REPUESTOS

BA 130/500



Scania
1789522
1787120

Bomba de agua - Serie 4
SCANIA SERIE P/G/R/T
MOTOR DC9 DC11 DT12

BA 130/501



Scania
1789555
1778923
1884327

Bomba de agua
SCANIA SERIE P/G/R/T
MOTOR DC13 DC-D5C9

REPUESTOS

RT 132/2



Bosch
V61183

Reten fuelle cremallera de bomba P

SCANIA VABIS

RT 132/3



Bosch
2 420 451 001

Fuelle para eje TPS

SCANIA 111/112

CA 132/4



Scania
02922811

De goma para tapa de válvula

SCANIA 113

REPUESTOS

CM 133/1



Bosch
2 447 222 000
Iveco
774 417

Corto

MERCEDES BENZ - HANOMAG - DEUTZ - IVECO

CM 133/1R



NP
155200-1120

Corto con resorte tipo Nippon Denso

MERCEDES BENZ - HANOMAG - DEUTZ - IVECO

CM 133/2



Bosch
2 447 222 001
Iveco
748 959

Largo

FIAT - VOLVO - MACK

CM 133/2R



NP
155200-1120

Largo con resorte tipo Nippon Denso

FIAT - VOLVO - MACK

CM 133/7



Bosch
2 447 222 125

Cebador capuchon. Modelo Nuevo

MERCEDES BENZ - SCANIA

REPUESTOS

CF 138/1	5 x 9 mm
CF 138/2	8 x 12 mm
CF 138/3	9,5 x 14 mm
CF 138/7	6 x 10 mm
CF 138/8	13 x 18 mm
CF 138/9	16 x 24 mm

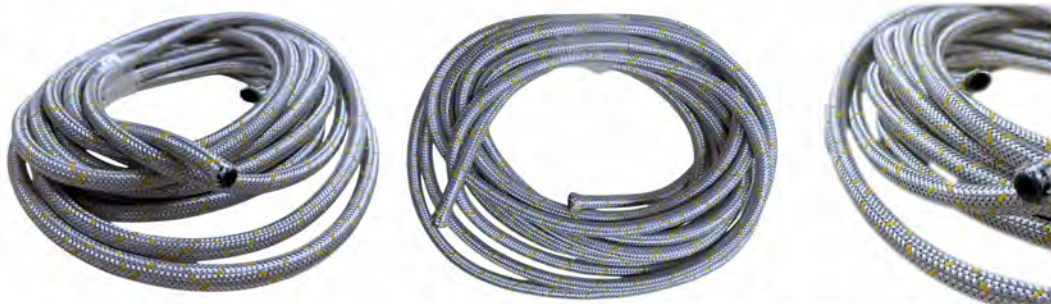
En rollo de 10 metros

REPUESTOS

CC 138/20	3 x 6 mm
CC 138/22	4 x 7 mm
CC 138/23	4 x 8 mm
CC 138/24	6 x 10 mm
CC 138/25	6 x 11 mm
CC 138/26	6 x 12 mm
CC 138/27	7 x 12 mm
CC 138/28	7 x 14 mm
CC 138/29	8 x 12 mm
CC 138/30	8 x 14 mm
CC 138/31	9 x 16 mm

En rollo de 50 metros

REPUESTOS

CH 138/35	3 x 6 mm
CH 138/36	4 x 7 mm
CH 138/37	4 x 8 mm
CH 138/38	6 x 10 mm
CH 138/39	6 x 12 mm
CH 138/40	7 x 11 mm
CH 138/41	7 x 12 mm
CH 138/42	7 x 14 mm
CH 138/43	8 x 14 mm
CH 138/44	9 x 6 mm

En rollo de 50 metros

REPUESTOS

CP 138/50	4 x 6 mm	Retorno de combustible
CP 138/51	6 x 8 mm	Lubricación de aceite
CP 138/52	7 x 10 mm	Combustible
CP 138/53	8 x 11 mm	Aire y Combustible
CP 138/54	9 x 12 mm	Aire
CP 138/54A	11 x 14 mm	Aire
CP 138/55	12 x 16 mm	
CP 138/55B	14 x 18 mm	
CP 138/56	Ø Int 1/4"	
CP 138/57	Ø Int 3/8"	
CP 138/58	Ø Int 1/2"	
CP 138/59	Ø Int 5/8"	



En rollo de 50 metros

REPUESTOS

CT 138/63	3 x 7 mm
CT 138/64	4 x 8 mm
CT 138/65	5 x 9,5 mm
CT 138/66	6 x 12 mm
CT 138/67	7 x 12 mm
CT 138/68	8 x 13 mm
CT 138/69	9 x 15 mm

En rollo de 50 metros

En rollo de 25 metros



REPUESTOS

CG 138/70	3 x 7 mm
CG 138/70A	4 x 8 mm
CG 138/70B	5,5 x 9 mm
CG 138/70C	6 x 12 mm
CG 138/70D	8 x 13 mm



En rollo de 50 metros



REPUESTOS

CD 139/19

Macho: M14x1,5
Hembra: M14x1,5



ADAPTADOR

Prolongador para bombita de llenado de circuito universal

SCANIA

CD 139/19A

Macho: M20x1,5
Hembra: M14x1,5



Conexión prolongador para bomba auxiliar (de llenado de circuito)

SCANIA

CD 139/38

M12x1,5 - 8 mm



Scania
2220509

Conector racord recto con vástago para purga de aire

SCANIA DC09/DC13/DC16 SERIE 6

REPUESTOS

CD 139/39

M12x1,5- Diam. interno M8x1

Scania
1490086

 Conector acoplamiento rápido metálico para aire.
Para MV 2090/2091/2092

SCANIA DC09/DC13/DC16

REPUESTOS

CP 139/B1

Conector para poliamida

SCANIA
CP 139/T15

Conector para poliamida

SCANIA
CP 139/Z12

Conector para poliamida

SCANIA

REPUESTOS

CI 140/107

Bosch
0431204016
KBL112S28/13
Scania
211977
211997

Cuerpo de inyector completo sin tobera

SCANIA 76/110/111 MOTOR DS11
CI 140/107A

Bosch
0431214997
KBEL109S6/13
Scania
257228

Cuerpo de inyector completo sin tobera

**SCANIA 112 MOTOR DS11
82/86 MOTOR DS18**
E 146/101

Espiga para inyector HPI

SCANIA DC12/DT12 CUMMINS ISX/QSX
DI 143/51

Bosch
2 420 503 002

Diafragma para TPS

SCANIA

REPUESTOS

EF 150/50B

 Diametro: 110 mm
Altura: 115 mm
Paso: Ø 22 , Ø17

Racor
900FG
2040PM

Elemento filtrante tipo Racor para FC 151/50B

SCANIA
EF 150/55

Mercedes Benz
457 09200 01
Racor
R 90-30MB
A: 109mm
B: 88 mm
C: 101 mm
G: 1" x 12 Hilos
H: Largo 144 mm
Largo con rosca vaso 160 mm

con rosca para filtro racor - br-90hm - para FC 151/46

SCANIA
EF 150/56

Racor
R 60-10M
A: 109 mm
B: 80 mm
C: 90 mm
G: 1" x 14 Hilos
H: Largo 120 mm
Largo con rosca vaso 130 mm

con rosca para filtro racor - br-60hm para FC 151/47 y/47A

SCANIA



REPUESTOS

EF 150/56P

CON VASO PLASTICO



Racor R 60-10M

con rosca para filtro racor - br-60hm para FC 151/47 y /47A

SCANIA - IVECO - FORD CARGO

EF 150/62



Man WK1060/1
Scania 1393640
Volvo 81599755

Elemento filtrante con vaso plástico tipo Racor

SCANIA P/R/T 114, 124P 94 - CATERPILLAR 3116
VOLVO FH12, NH12, NI12 BUSES B7R-230, B7R-280

EF 150/64x2



Scania 2779191
1794863
1865227
1736248
1736250
2003505
1920628

Elementos filtrantes de combustibles [2 unidades] PU10003-2x
Kit PU10007 + PU9004 (con junta)

**SCANIA SERIES G / P / R / K310
DC09 - DC13**



REPUESTOS

EF 150/201-R



Mercedes Benz	Iveco	MAN
A0004300969	2992261	81521086001
A0004300669	01907612	81521020008
A0004393395	08123564	81521020009
A0004291097	08190948	81521020010
A0004293695	Renault	81521020013
A0004293795	5000295421	81521020019
A0004293595	5001004902	81521020015
A0004291297	7421267820	82521020013
Scania	5001832112	99100360822
1111131	Evobus	John Deere
1375997	8285141196	A1204884
377640	Hyundai	Wabco
Tecfil	95680 7R000	4324100202
DSF0202		4329980202

Filtro secador de aire de freno DMB - Rosca derecha

SCANIA SERIE 3

EF 150/202



Wabco	Scania
4324102262	1348549
DAF	1455253
1504935	1744598
1523992	1774598
1527759	1932690
MAN	2081360
N2509990182	2307617
Renault	2562323
5001843522	5021170077
5021170077	57142020
7485137862	

Filtro secador de aire de freno DMB

SCANIA 140L G320LB/G360LB/G440EURO6/G450CB
G94/R94/T114/T124/T144



REPUESTOS

FC 151/35



Entrada derecha con rosca de 14 x 1.5 mm

Filtro de combustible con unidad sellada

DEUTZ - SCANIA

FC 151/36



Entrada y salida de rosca de 14 mm x 1.5

Filtro de combustible simple

DEUTZ - SCANIA - UNIVERSAL

FC 151/36B



Rosca de 1/8 gas p/ manguera

Filtro de combustible simple

DEUTZ - SCANIA - VS

FC 151/37



Entrada y salida de rosca de 14 mm x 1.5

Filtro de combustible doble con unidad sellada

SCANIA 111 / 112 - VS

FC 151/46

Rosca 1" - 12 hilos Ent y sal M14x1,5



Mercedes Benz 4760907452
Racor 690-10HP

P/PURG= M21x1,25-6h

Filtro de combustible tipo Racor

SCANIA P94/114/124/OMNIBUS 114/124

FC 151/46P



Rosca 1" - 12 hilos Ent y sal M14x1,5

CON VASO PLASTICO
Mercedes Benz 4760907452
Racor 690-10HP

Filtro trampa de agua tipo Racor

SCANIA P94/114/124/OMNIBUS 114/124

FC 151/47

R=1"-14h / E/S=M14x1,5



P/PURG= M21x1,25-6h

Filtro de combustible tipo Racor

Scania 523901

**SCANIA CAMIONES Y OMNIBUS - FORD CARGO 14000
CAMION C/MOTOR CUMMINS - M.BENZ OM366A
CAMIONES 1620/1218 - IVECO EUROCARGO/BRASIL**

FC 151/47P

R=1"-14h / E/S=M14x1,5

FC 151/47AP

R=1"-14h / E/S=M16x1,5



Scania 523901

Filtro de combustible tipo Racor

**SCANIA CAMIONES Y OMNIBUS
CAMION C/MOTOR CUMMINS**

FC 151/50B

Entrada y Salida 7/8" - 14



Racor 900FG

Filtro armado de combustible tipo Racor

VOLVO - SCANIA

REPUESTOS

FC 151/50C



Racor
1000FG

Filtro armado de combustible tipo Racor

VOLVO - SCANIA

FC 151/53



Rosca filtro: 1"-14
Entrada y salida: M14x1,5

Mann
WK 1060/1
Scania
1393640
Caterpillar
81599755

Filtro trampa de agua armada tipo Racor R90P

SCANIA P/R/T 114, 124P94 - CATERPILLAR 3116
VOLVO Fh12, Nh12, Ni12 BUSES B7R-230, B7R-280

REPUESTOS

FM 152/1



Bosch
1450410011

Metálico - De vasito bombita alim. y prefiltro t/ Bosch

MERCEDES BENZ - FIAT - DEUTZ
SCANIA - VOLVO - VS

FM 152/3



Bosch
1450410011

Plástico - de vasito bombita alim. y prefiltro t/ Bosch

MERCEDES BENZ - FIAT - DEUTZ
SCANIA - VOLVO - VS

FM 152/22



R= M22 x 1.5 mm

Filtro para tanque de aire

MERCEDES BENZ

FM 152/23



Filtro de tanque de aire de freno "VOLTEO"

MERCEDES BENZ

FM 152/101



Scania
1421174
ED3087316
Cummins
3348004

Filtro blanco DMB para inyector HPI

SCANIA DC12 / DT12 CUMMINS ISX/QSX

FM 152/102



Filtro negro DMB para inyector HPI

SCANIA DC12 / DT12 CUMMINS ISX/QSX

REPUESTOS

JR 155/60



Ref. 1 1-JUN 156/66A (2 440 109 005)
Ref. 2 1-FM 152/3 (1 450 410 011)
Ref. 3 1-RB 180/3 (2 454 642 000)
Ref. 4 1-VAS 225/21L (2 459 999 002)

Bosch
2 447 010 017

Kit de reparación para bomba alimentadora tipo Bosch con vaso liso

VS

JR 155/61



Bosch
2447010032

Kit vaso plástico modelo nuevo para bombita alimentadora tipo Bosch

MERCEDES BENZ

JR 155/64

Diam. 6 mm



Conjunto de reparación de emergencia para mangueras de poliamida

VS

JR 155/65

Diam. 8 mm



Conjunto de reparación de emergencia para mangueras de poliamida

VS

JR 155/66

Diam. 11 mm



Conjunto de reparación de emergencia para mangueras de poliamida

VS

JR 155/67

Diam. 12 mm



Conjunto de reparación de emergencia para mangueras de poliamida

VS

REPUESTOS

JR 155/79

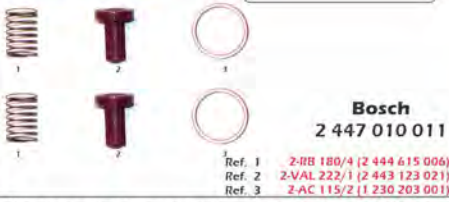

Bosch
2 447 010 011

- Ref. 1 2-RB 180/4 (2 444 615 004)
- Ref. 2 2-VAL 222/1 (2 443 123 021)
- Ref. 3 2-AC 115/2 (1 230 203 001)

Kit de reparación para bomba alimentadora tipo Bosch

VS

JR 155/81

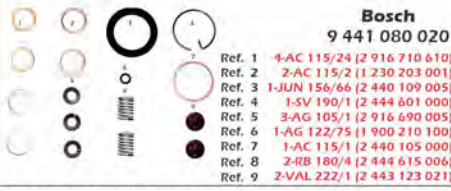

Bosch
9 441 080 020

- Ref. 1 4-AC 115/24 (2 916 710 610)
- Ref. 2 2-AC 115/2 (1 230 203 001)
- Ref. 3 1-JUN 156/66 (2 440 109 005)
- Ref. 4 1-SV 190/1 (2 444 601 000)
- Ref. 5 3-AG 105/1 (2 916 690 005)
- Ref. 6 1-AG 122/75 (1 900 210 100)
- Ref. 7 1-AC 115/1 (2 440 105 000)
- Ref. 8 2-RB 180/4 (2 444 615 006)
- Ref. 9 2-VAL 222/1 (2 443 123 021)

Kit de reparación para bomba alimentadora tipo Bosch

VS

JR 155/82

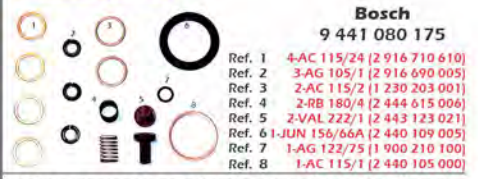

Bosch
9 441 080 175

- Ref. 1 4-AC 115/24 (2 916 710 610)
- Ref. 2 3-AG 105/1 (2 916 690 005)
- Ref. 3 2-VAL 222/1 (2 443 123 021)
- Ref. 4 2-RB 180/4 (2 444 615 006)
- Ref. 5 2-VAL 222/1 (2 443 123 021)
- Ref. 6 1-JUN 156/66A (2 440 109 005)
- Ref. 7 1-AG 122/75 (1 900 210 100)
- Ref. 8 1-AC 115/1 (2 440 105 000)

Kit de reparación para bomba alimentadora tipo Bosch

VS

JR 155/83



Bosch
2 447 010 016
2 447 010 003

- Ref. 1 1-JUN 156/66A (2 440 109 005)
- Ref. 2 1-FM 152/1 (1 450 410 011)
- Ref. 3 1-RB 180/3 (2 454 642 000)

Kit de reparación para bomba alimentadora tipo Bosch y prefiltro tipo Bosch

VS

JR 155/84



Bosch
2 447 010 004

- Ref. 1 2-AC 115/2 (1 230 203 001)
- Ref. 2 1-AG 122/75 (1 900 210 100)
- Ref. 3 2-VAL 222/1 (2 443 123 021)
- Ref. 4 2-RB 180/4 (2 444 615 006)
- Ref. 5 4-AC 115/24 (2 916 710 610)
- Ref. 6 1-JUN 156/1 (1 411 073 002)
- Ref. 7 1-AC 115/1 (2 440 105 000)
- Ref. 8 1-SV 190/1 (2 444 601 000)

Kit de reparación para bomba alimentadora tipo Bosch

VS

JR 155/84A

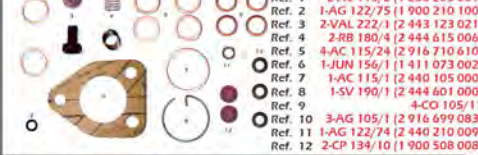

Bosch
2 447 010 004

- Ref. 1 2-AC 115/2 (1 230 203 001)
- Ref. 2 1-AG 122/75 (1 900 210 100)
- Ref. 3 2-VAL 222/1 (2 443 123 021)
- Ref. 4 2-RB 180/4 (2 444 615 006)
- Ref. 5 4-AC 115/24 (2 916 710 610)
- Ref. 6 1-JUN 156/1 (1 411 073 002)
- Ref. 7 1-AC 115/1 (2 440 105 000)
- Ref. 8 1-SV 190/1 (2 444 601 000)
- Ref. 9 4-CO 105/11
- Ref. 10 3-AG 105/1 (2 916 699 083)
- Ref. 11 1-AG 122/74 (2 440 210 009)
- Ref. 12 2-CP 134/10 (1 900 508 008)

Kit de reparación para bomba alimentadora tipo Bosch

VS

JR 155/85

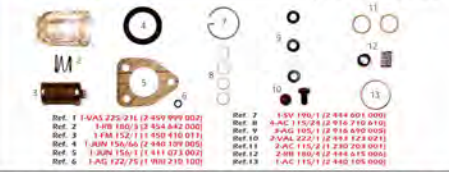

Bosch
2 447 010 004Z

- Ref. 1 1-VAS 225/211 (2 459 999 002)
- Ref. 2 1-RB 180/3 (2 454 642 000)
- Ref. 3 1-FM 152/1 (1 450 410 011)
- Ref. 4 1-RB 180/4 (2 444 615 006)
- Ref. 5 1-JUN 156/1 (1 411 073 002)
- Ref. 6 1-AG 122/75 (1 900 210 100)
- Ref. 7 1-SV 190/1 (2 444 601 000)
- Ref. 8 4-AC 115/24 (2 916 710 610)
- Ref. 9 2-AG 105/1 (2 916 690 005)
- Ref. 10 2-VAL 222/1 (2 443 123 021)
- Ref. 11 2-AC 115/2 (1 230 203 001)
- Ref. 12 2-RB 180/4 (2 444 615 006)
- Ref. 13 1-AC 115/1 (2 440 105 000)

Kit de reparación para bomba alimentadora tipo Bosch

VS

JR 155/86

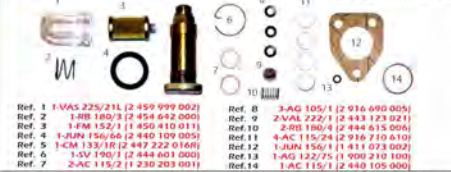

Bosch
2 447 010 004S

- Ref. 1 1-VAS 225/211 (2 459 999 002)
- Ref. 2 1-RB 180/3 (2 454 642 000)
- Ref. 3 1-FM 152/1 (1 450 410 011)
- Ref. 4 1-JUN 156/66 (2 440 109 005)
- Ref. 5 1-CM 135/10 (2 447 222 016)
- Ref. 6 1-SV 190/1 (2 444 601 000)
- Ref. 7 2-AC 115/2 (1 230 203 001)
- Ref. 8 3-AG 105/1 (2 916 690 005)
- Ref. 9 2-VAL 222/1 (2 443 123 021)
- Ref. 10 2-RB 180/4 (2 444 615 006)
- Ref. 11 4-AC 115/24 (2 916 710 610)
- Ref. 12 1-JUN 156/1 (1 411 073 002)
- Ref. 13 1-AG 122/75 (1 900 210 100)
- Ref. 14 1-AC 115/1 (2 440 105 000)

Kit de reparación para bomba alimentadora tipo Bosch y prefiltro tipo Bosch

VS

JR 155/87



Bosch
1 457 434 000

- Ref. 1 1-VAS 225/211 (2 459 999 002)
- Ref. 2 1-RB 180/3 (2 454 642 000)
- Ref. 3 1-FM 152/1 (1 450 410 011)
- Ref. 4 1-JUN 156/66 (2 440 109 005)
- Ref. 5 1-SV 190/9 (9 441 060 033)
- Ref. 6 4-AC 115/24 (2 916 710 610)
- Ref. 7 1-TV 194/2 (2 459 999 001)
- Ref. 8 2-RP 129/16 (2 916 710 610)

Kit de reparación para bomba alimentadora tipo Bosch

VS

JR 155/89



De bba. P. contiene 4 laminas, 4 bujes, y 4 arandelas planas.

MERCEDES BENZ 1526

JR 155/89/AC



ACERO REFORZADO

De bba. P. contiene 4 laminas, 4 bujes, y 4 arandelas planas.

MERCEDES BENZ 1526

JR 155/90



De bba. P. contiene 4 laminas, 4 bujes, y 4 arandelas planas.

SCANIA 112

JR 155/90AC



ACERO REFORZADO

De bba. P. contiene 4 laminas, 4 bujes, y 4 arandelas planas.

SCANIA 112

JR 155/91



De bba. P. contiene 6 laminas, 6 bujes, y 6 arandelas planas.

SCANIA 113

JR 155/91AC



ACERO REFORZADO

De bba. P. contiene 6 laminas, 6 bujes, y 6 arandelas planas.

SCANIA 113

JR 155/98



Kit con tapón de 22mm con válvula T/M p bomba alim.

SCANIA

JR 155/99



Kit con tapon de 24mm con válvula T/M p Bomba Alim.

MERCEDES BENZ

Mercedes Benz
A0000900810
Bosch
2447010024
2447010043



REPUESTOS

JR 155/311AG

Ref. Original
Scania
1422564

Bosch
F00VX99999

AG 122/600

AG 122/601

AG 122/602

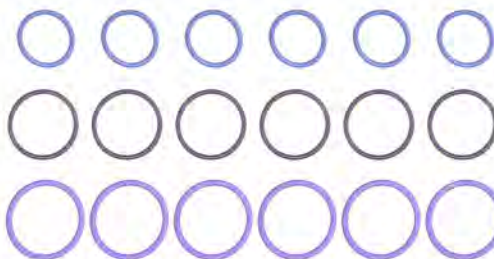

Kits de Oring's para inyector bomba sistema PDE

SCANIA SERIE 4



REPUESTOS

JUN 156/1



Bosch
1411073002

Para bomba de acople bombita tipo "A"

VS

JUN 156/8



Bosch
1411073000
1411073004

Para base de bomba alimentadora Tipo A mod. Nuevo Angosta

VS



REPUESTOS

JUN 156/66A



Bosch
2440109005

De vasito tipo Bosch goma gruesa

VS



REPUESTOS

JUN 156/355T



Juego de junta para turbo

SCANIA 111/112 - MERCEDES BENZ 1526 OM355/6
TV6114/4LGZ/4LE

JUN 156/449T



Juego de junta para turbo

SCANIA 133 - MERCEDES BENZ 1630/1633 OM447/449
TA45/GT45/S400

REPUESTOS

LA 158/4
COMUN

LA 158/4/AC
ACERO
REFORZADO

Bosch
1 410 136 005

Lamina de acople
SCANIA VABIS - CHEVROLET 350 - DEUTZ
MOTOR NISSAN 165/205 - ISUZU 6BD1 - HINO

LA 158/10
COMUN

LA 158/10/AC
ACERO
REFORZADO

Volvo
417512

Lamina de acople grande super 110
SCANIA GRANDE SUPER 110/VOLVO B58/B10M
C/MOTOR THD 100 EC/THD121GB/THD101KC/THD101G

LA 158/11
COMUN

LA 158/11/AC
ACERO
REFORZADO

Bosch 1 410 136 007
Volvo 457512
MWM 606904030002

Lamina de acople grande
SCANIA VABIS L-111 - MERCEDES BENZ 1526
OM 355-5 / OM 355-6 - VOLVO LINEA NL

LA 158/13
COMUN

LA 158/13/AC
ACERO
REFORZADO

Bosch 2 411 098 074
Scania 392204

Lamina de acople cuadrada
SCANIA 112

LA 158/15
COMUN

LA 158/15/AC
ACERO
REFORZADO

Bosch
3 410 190 500

Lamina de acople ondulada
SCANIA 113

REPUESTOS

MA 159/7

Tipo original
SCANIA VABIS

MA 159/10

De bomba brasilera
Scania 005073
YUGO - SCANIA VABIS 110/111

MA 159/11

Tipo original
Scania 340273
SCANIA 112

REPUESTOS

LE 159/50

PARA ESCRIBIR O MARCAR EN:
Superficies cementadas
Metales de alta dureza
Aceros templados
Herramientas
Calibres
Tensión 220 V-50 C
Potencia 400 Va

Lápiz eléctrico
VS

LE 159/50A

Punta para lápiz eléctrico
VS

MIA 159/101

Agilise antes de usar
CONTENIDO NETO 60 cm³
INDUSTRIA ARGENTINA

Trazo 1/8" - Color amarillo
Contenido Neto **60** cm³

Para marcar, numerar y codificar todo tipo de metales plásticos, maderas, gomas, cerámicas, etc. Escribe inclusive sobre superficies aceitosas y rústicas, resiste temperatura e intemperie. Provisto en envase de plástico, flexible, anatómico.

MARCADOR INDUSTRIAL - PINTURA PARA PRECINTO

REPUESTOS

PLQ 164/9

18 x 5



Bosch	M.Benz
2430136166	0010177252
Iveco	Scania
9941816	395767
Deutz	Volvo
1321088	1698513

De inyector

SCANIA 113 MOTOR DSC11

PLQ 164/12

18 x 7



Bosch	MWM
2430136085	606907251405
2430136007	Iveco
Scania	42490269
269785	Volvo
	846292

De inyector

SCANIA 112

REPUESTOS

PREF 168/1



Bosch
1 457 434 000

Prefiltro

SCANIA

PREF 168/1A



Bosch
2 457 434 009

Prefiltro - Modelo nuevo con vaso plastico

SCANIA

REPUESTOS

PT 170/6



Bosch
2 433 314 057

Portatobera

SCANIA VABIS L-111
DLLA150S615 - DLLA150S616

PT 170/20



Bosch
2 433 314 023
2 433 349 213

Portatobera

SCANIA VABIS L-112
DLLA150S853

PT 170/39



Bosch
2 433 349 472

Portatobera

SCANIA 112 TURBO / INTERCOOLER
DLLA46P154

PT 170/47



Bosch
2 433 314 042

Portatobera

SCANIA 113 INY BOSCH INTERCOOLER
DLLA155P230 - DLLA155P306 - DLLA142P221

PT 170/72



Bosch
2 433 349 304

Portatobera para inyección doble etapa

SCANIA 114/124

REPUESTOS

RAC 173/27



Bosch
2433370035
Scania
275368

De tubo de presión, entrada de inyector

SCANIA 112 MOTOR DS11 - 82/86 MOTOR DS18

RAC 173/28



Bosch
2433370110
Scania
193567

De tubo de presión, entrada de inyector

SCANIA 76/110/111 MOTOR DS11

RAC 173/33

20x1,5 / 14x1,5



De entrada bomba llenado - Racord reductor

SCANIA

RAC 173/38

M22



Bosch
2 443 461 003

Racord tapón con válvula para bomba alimentadora

BOMBAS SCANIA 0 440 008 074

RAC 173/39

M24



Bosch
2 443 461 020
Iveco
9967629
Scania
1374596
Volvo
3094340

Racord tapón con válvula para bomba alimentadora

BOMBAS 0 440 008 072
0 440 008 079 - 0 440 008 089

REPUESTOS

RB 180/1



Bosch
2 444 615 007

De botador de bomba alimentadora tipo Bosch (todas)

VS

RB 180/2



Bosch
2 444 617 010

De botador de bomba alimentadora tipo Bosch (todas)

VS

RB 180/3



Bosch
2 444 615 007
Iveco
772 161

De filtro para vaso de bomba y prefiltro tipo Bosch (todas)

VS

RB 180/4



Bosch
2 444 615 006
Fiat
705 639
Iveco
772 127

De válvula de bomba alimentadora tipo Bosch (todas)

VS

REPUESTOS

REL 185/5

30x42x7



Bosch
2 410 283 010

De bomba P con guardapolvo

FIAT - SCANIA 112

REL 185/22

35x47x7



Bosch
2 410 283 018
2 410 283 024

De bomba P con guardapolvo

SCANIA 113

REL 185/101



Scania
1801418

Retén para inyector HPI

SCANIA DC12/DT12 CUMMINS ISX/QSX

REPUESTOS

SCI 188/8



3 Caños

MERCEDES BENZ 1114 - DEUTZ - VS

SCI 188/9



2 Caños

MERCEDES BENZ 1114 - DEUTZ - VS

SCI 188/14



4 Caños

MERCEDES BENZ - DEUTZ - IVECO
SCANIA - FIAT - VS

Iveco
4734007

SCI 188/15



6 Caños

MERCEDES BENZ - DEUTZ - IVECO
SCANIA - FIAT - VS

Iveco
4806614

SCI 188/18



5 Caños

MERCEDES BENZ - DEUTZ - IVECO
SCANIA - FIAT - VS

REPUESTOS

SV 190/9



Bosch

9 441 080 033

Alambre ajuste vaso tipo original

MERCEDES BENZ

SV 190/16



Seguro para horquilla TPS Bosch

SCANIA

REPUESTOS

SO 191/39C

12 Volts



Cod. Original
SA-3799-12

Solenoides de pare completo
MOTORES ESTACIONARIOS
SCANIA (Grupos Electrogenos)

SO 191/39CK

12 Volts

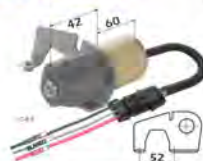

Woodward
SA-3799-12

Solenoides de pare completo - corto
MOTORES ESTACIONARIOS
SCANIA (Grupos Electrogenos)

SO 191/40C

24 Volts



Cod. Original
SA-3799-24

Solenoides de pare completo
MOTORES ESTACIONARIOS
SCANIA (Grupos Electrogenos)

SO 191/40CK

24 Volts



Woodward
SA-3799-24

Solenoides de pare completo - corto
MOTORES ESTACIONARIOS
SCANIA (Grupos Electrogenos)

SO 191/88C

12 Volts



Solenoides de pare completo

SCANIA

SO 191/89C

24/28 Volts



Solenoides de pare completo

SCANIA

REPUESTOS

SO 191/151

24 Volts



Bosch
2417213007
Case
9970198

Solenoido electroimán de empuje

SCANIA 124

SO 191/151A



Bosch
2417205022
Scania
1370084
Case
9970197

Solenoido electroimán de empuje con carcasa de aluminio

SCANIA 113 / 114 / 124

SO 191/151B



Bosch
2417205026
Scania
1368171

Solenoido electroimán de empuje con carcasa de aluminio

SCANIA 94 MOTOR 9.0 L

REPUESTOS

TV 194/1

R= 14 x 1.5



Tapa de prefiltro tipo Bosch modelo nuevo

SCANIA

TV 194/2

R= 14 x 1.5



Bosch
2 459 999 001
Iveco
129 0638

Soporte prefiltro bomba alimentadora tipo Bosch

VS

TV 194/34

R = 14 x 1.5



Tapa duofiltro para unidad sellada

SCANIA

TV 194/38

Ent/Sal=14mm - Rosca 16x1,5

TV 194/38A

Ent/Sal=12mm - Rosca 16x1,5

TV 194/38B

Ent/Sal=1/8gas - Rosca 16x1,5

TV 194/38C

Ent/Sal= 1/2x20 - Rosca 3/4x16



Para filtro interior

SCANIA

TV 194/44

R = 1" - 12 hilos

Entrada y salida : M14x1.5



M. Benz
376 092 7108

Tapa de filtro de combustible tipo Racor
SCANIA CAMIONES P94/114/124/OMNIBUS
114/124

TV 194/45

R = 1" - 14 hilos

Entrada y salida : M14x1.5

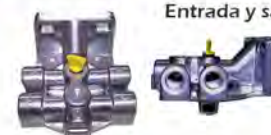

Tapa de filtro de combustible tipo Racor

SCANIA CAMIONES Y OMNIBUS

TV 194/46



Entradas frontales ciegas.
Entrada y salida lateral rosca 14 x 1,5.
Rosca macho p/ armado de filtro 16 x 1,5.



Scania
0525356

Tapa duofiltro para unidad sellada

SCANIA

TV 194/48A

Diam. de apoye filtro: Ext 106mm - Int 75mm
R=1"-14 / Ent. y sal. M16x1,5



Tapa con botón, filtro de combustible tipo RACOR

SCANIA

TV 194/48C

Diam. de apoye filtro: Ext 106mm - Int 75mm
R=1"-14 / Ent. y sal. M14x1,5



Tapa con botón, filtro de combustible tipo RACOR

SCANIA

REPUESTOS

TOR 202/2



Bosch
1 413 453 020

Tipo Bosch con cabeza hexagonal

VS

TOR 202/9

Rosca 3/8" x 24h



Perkins
001 901

De filtro, plástico

PERKINS - DEUTZ

REPUESTOS

UN 217/1

8 mm



Unión de acero - Con vástago

SCANIA

UN 217/2

8 mm



Unión de acero de doble salida

SCANIA

UN 217/3

8 mm



Unión de acero de doble salida en V

SCANIA

REPUESTOS

UN 217/16

12 mm



Con vástago de 7mm p/manguera o poliamida de 1/4" (6,35mm)

VS

UN 217/17

12 mm



Con vástago de 8,5mm p/manguera o poliamida de 8mm

VS

UN 217/18

12 mm



Con vástago de 9,5mm p/manguera o poliamida de 3/8" (8mm)

VS

UN 217/19

13 mm



Con vástago de 7mm p/manguera o poliamida de 1/4" (6,35mm)

VS

UN 217/20

13 mm



Con vástago de 8,5mm p/manguera o poliamida de 8mm

VS

UN 217/21

13 mm



Con vástago de 10mm p/manguera o poliamida de 3/8" (9mm)

VS

UN 217/22

14 mm



Con vástago de 7mm p/manguera o poliamida de 1/4" (6,35mm)

VS

UN 217/23

14 mm



Con vástago de 8,5mm p/manguera o poliamida de 8mm

VS

UN 217/24

14 mm



Con vástago de 10mm p/manguera o poliamida de 3/8" (9mm)

VS

UN 217/25

10 mm



Con vástago de 7,5mm p/manguera o poliamida de 1/4" (6,35mm)

VS

UN 217/26

12 mm



Con vástago de 7,5mm p/manguera o poliamida de 1/4" (6,35mm)

VS

UN 217/27

16 mm



Con vástago de 12mm p/manguera o poliamida de 1/2" (12,7mm)

VS

REPUESTOS

UC 218/PE06	Para Poliamida de 6 mm
UC 218/PE08	Para Poliamida de 8 mm
UC 218/PE10	Para Poliamida de 10 mm
UC 218/PE12	Para Poliamida de 12 mm
UC 218/PE14	Para Poliamida de 14 mm
UC 218/PE16	Para Poliamida de 16 mm
UC 218/PE1/4	Para Poliamida de 1/4"
UC 218/PE3/8	Para Poliamida de 3/8"
UC 218/PE1/2	Para Poliamida de 1/2"
UC 218/PE5/16	Para Poliamida de 5/16"



Union Conectora para Poliamida
(TEE - Tubo - Tubo) Modelo PE

VS

UC 218/PU06	Para Poliamida de 6 mm
UC 218/PU08	Para Poliamida de 8 mm
UC 218/PU10	Para Poliamida de 10 mm
UC 218/PU12	Para Poliamida de 12 mm
UC 218/PU14	Para Poliamida de 14 mm
UC 218/PU16	Para Poliamida de 16 mm
UC 218/PU1/4	Para Poliamida de 1/4"
UC 218/PU3/8	Para Poliamida de 3/8"
UC 218/PU1/2	Para Poliamida de 1/2"
UC 218/PU5/16	Para Poliamida de 5/16"



Union Conectora para Poliamida
(Tubo - Tubo) Modelo PU

VS

REPUESTOS

SCANIA

- UC 218/PV04** Para Poliamida de 4 mm
- UC 218/PV06** Para Poliamida de 6 mm
- UC 218/PV08** Para Poliamida de 8 mm
- UC 218/PV10** Para Poliamida de 10 mm
- UC 218/PV12** Para Poliamida de 12 mm
- UC 218/PV1/4** Para Poliamida de 1/4"
- UC 218/PV3/8** Para Poliamida de 3/8"
- UC 218/PV1/2** Para Poliamida de 1/2"
- UC 218/PV5/16** Para Poliamida de 5/16"



Union Conectora para Poliamida (Tubo - 90°) Modelo Pv

VS

REPUESTOS

SCANIA

VAL 221/15

14 x 1.5
Presión 1.5kg



Bosch
1 457 413 013

Válvula de sobrepresión

SCANIA VABIS/111/112

VAL 221/15A

14 x 1.5
Presión 2kg



Iveco
500328251
Bosch
1457413013

Válvula de sobrepresión

SCANIA VABIS/111/112

VAL 221/15B

14 x 1.5
Presión 1kg



Válvula de sobrepresión

SCANIA 111/112

VAL 221/16

14 x 1.5



Válvula para bomba P

FIAT 619 N

VAL 221/17

14 x 1.5



Bosch
1 417 413 047

Válvula

MERCEDES BENZ 1114

VAL 221/19A

10 mm



Válvula anti-retorno de entrada y salida recta

VS

VAL 221/23

14 x 1.5



Bosch
1 417 413 082

Válvula

SCANIA 124

VAL 221/31



Scania
1379215
1864034
Bosch
2 417 413 092

Válvula

SCANIA 420

REPUESTOS

VAL 222/1



Bosch
2 443 123 021
Fiat
763 178

Para bomba alimentadora tipo Bosch (todas) Color Roja

VS

VAL 222/2



Bosch
2 443 203 001
1 414 027 300
Iveco
773 987
Lucas/Delphi
7027-121

Para bomba alimentadora tipo Bosch (todas) Color Blanca

VS

VAL 222/3

Ø19mm



Lucas/Delphi
7092-256A
-
AC 559 3866

Para bomba alimentadora (todas)

SCANIA

VAL 222/4

Ø18mm



Bosch
2 447 419 002
2 447 419 002

Para bomba alimentadora Bosch tipo M

SCANIA

REPUESTOS

VAS 225/1



Vaso de plástico para prefiltro Bosch

SCANIA

VAS 225/12



Vaso de plástico especial para prefiltro tipo Bosch

VS

VAS 225/19C



Vaso decantador de plástico para filtro Racor

SCANIA

Racor
KR-27004
Mercedes Benz
3760927104
Scania
524014

VAS 225/20B



Vaso decantador de plástico para filtro Racor y trampa de 1000 para FC 151/50B

SCANIA

Racor
900FG
1000FG

VAS 225/21L



Vaso de vidrio para prefiltro tipo Bosch liso

VS

Bosch
2 459 999 002

VAS 225/41



Vaso de aluminio decantador para conjunto filtro tipo Racor

SCANIA

Rosca P/Purgador
M21 x 1,25 - 6H

Scania
524 014
M. Benz
376 092 7104
Racor
KR 27004

VAS 225/41C

Rosca P/Purgador
M21 x 1,25 - 6H



Scania
524 014
M. Benz
376 092 7104
Racor
KR 27004

Contiene: Vaso decantador, o ring y purgador
Vaso de aluminio decantador para conjunto filtro tipo Racor

SCANIA

TOBERAS

tmDLA142P221	0433171180	Scania PO 3 HL / HR - PO3 / 210 / 250 / 230 / 0 430 133 992 KBEL 97 P 10
tmDLA146P154	0433171165	Scania 112 Intercooler (BOMBA 7126) / 0 430 133 992 KBEL 97 P 10
tmDLA147P538	0433171398	Scania 265 motor DSC 12.02 / 0 430 133 948 KBEL 100 P 62
tmDLA150S853	0433271829	Saab Scania L-112.(c/turbo) - 0 431 214 997 KBAL 109 S 6/13
tmDLA155P230	0433171188	Scania 113 Intercooler / 0 430 133 989 KBEL 97 P 13
tmDLA155P306	0433171221	Scania P 113 / 400 - R 113 / 0 430 133 989 KBEL 97 P 13



ELEMENTOS

em2418450067	2418450067	Saab Scania DS-11 Tucumano turbo
em2418455129	2418455129	Saab Scania L-112
em2418455134	2418455134	Scania Intercooler Mercedes Benz LS 1633 - LS 1938
em2418455165	2418455165	Scania L-113 / LC 250
em2418455518	2418455518	Scania P / R / T 124 C / G / L motor DSC 12-02 (Euro II) N° de bomba 0402946014
em2418455542	2418455542	Scania PR 94 / 310 / T94 / 310 / L94
em2418455548	2418455548	Scania P/R/Rt 114 - T/R 114



VÁLVULAS

vm2418554033	2418554033	Saab Scania DS-11tucumano turbo use 2 418 554 015 / 017
vm2418554045	2418554045	Scania 112 sin turbo
vm2418554047	2418554047	Saab Scania L 112 con turbo
vm2418554065	2418554065	Scania 112 Intercooler
vm2418554069	2418554069	Scania Argentina 113
vm2418554077	2418554077	Scania K113 Omnibus



ssS1881260



Scania
1881260
1393113
1452862
1488340

Sensor de presión de aceite DMB

SCANIA SERIE 3 DSC12 / SERIE 4 DC12

ssS395641



Scania
395641
264816
Volvo
4880804

Sensor de velocidad DMB

SCANIA P94/R113/T113/F114/P114/R114/T114/K114
P124/R124/T124/K124/R143/T143/R164

REPUESTOS

cm1122-576



Injectores
0414701008 0414701057
04147010019 0414701067
0414701045

Bosch
0433171576
Scania
1412401

Tobera Common rail - DLLA150P848

SCANIA 114 340-381 1995 MOTOR 10,6D DC11,03 DC11,04
124 360-420 1995 MOTOR 12,0D DC12,02 K IB BUS EURO 3 P360 T400 T420
164 480 2000-2004 MOTOR DC16,01 DC16,02 R480 T480 EURO3

cm1522-2320



Scania
P2872320

Tobera para inyector 2872544 Cummins XPI

SCANIA D9 - D13

cm1522-2321



Scania
P2872321

Tobera para inyectores 2031835/2086663 Cummins XPI

SCANIA D9 - D13

cm1522-4025



Scania
P4384025

Tobera para inyectores 2488244 Cummins XPI

SCANIA D9 - D13

cm1522-4708



Scania
P4954708

Tobera para inyectores 2872405 Cummins XPI

SCANIA D9 - D13

cm1522-7551



Scania
P2897551

Tobera para inyectores 2057401 Cummins XPI

SCANIA D9 - D13

REPUESTOS

cm1520-1835



Scania
2031835
2086663
1881564

Inyector DMB Cummins XPI

SCANIA D9 - D13

cm1520-2284



Scania
2872284
2872289
4955080

Inyector DMB Cummins XPI

SCANIA D9 - D13

cm1520-2544



Scania
2872544

Inyector Cummins XPI

SCANIA D9 - D13

cm1520-2544A



Scania
2872544

Inyector original Cummins XPI

SCANIA D9 - D13

cm1520-7401



Scania
2057401

Inyector DMB Cummins XPI

SCANIA D9 - D13

cm1520-7401A



Scania
2057401

Inyector DMB Cummins XPI

SCANIA D9 - D13

cm1520-8244



Scania
2488244

Inyector DMB Cummins XPI

SCANIA D9 - D13

REPUESTOS

cm1525-4811



Scania
5314811

Válvula DMB para inyector Cummins XPI
SCANIA D9 - D13

REPUESTOS

cm2171-006



Kit de o-rings externo

SCANIA - BOSCH

cm2171-008



Kit de o-rings externo

SCANIA - BOSCH

Scania
1440576
Iveco
500379769
Bosch
F00VX99995

cm2171-012



Kit de o-rings para solenoides

SCANIA - BOSCH

cm2171-018

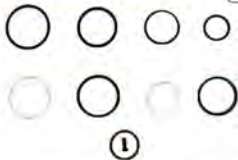

Kit de o-rings para inyector mas solenoide

SCANIA

cm2171-020



Kit para Scania

SCANIA - BOSCH PDE90/PDE100

Bosch
F00HN37912
Scania
1541175

REPUESTOS

AC 115/505



Cummins
4307148

Arandela para inyector HPI

**SCANIA DC12/DT12 - VOLVO - NAVISTAR
CUMMINS ISX/QSX**

AC 115/506



Arandela de cobre externa de asiento de inyector XPI
**SCANIA R450/R550 - DC09/DC13/DC16 - P/G/R/T
CUMMINS ISX15**

E 146/101



Espiga para inyector HPI

**SCANIA DC12/DT12 - VOLVO - NAVISTAR
CUMMINS ISX/QSX**

FM 152/101



Scania
1421174
ED3087316
Cummins
3348004

Filtro blanco DMB para inyector HPI

**SCANIA DC12/DT12 - VOLVO - NAVISTAR
CUMMINS ISX/QSX**

FM 152/102



Filtro negro DMB para inyector HPI

**SCANIA DC12/DT12 - VOLVO - NAVISTAR
CUMMINS ISX/QSX**

Scania
1434707
Cummins
4006962

REL 185/101



Retén para inyector HPI

**SCANIA DC12/DT12 - VOLVO - NAVISTAR
CUMMINS ISX/QSX**

Scania
1801481

REPUESTOS

cm2571-1237



Scania
1441237

Kit de reparación DMB para inyector HPI
SCANIA DC12/DT12 - VOLVO - NAVISTAR
CUMMINS ISX/QSX

cm2571-1240



Kit espiga y retén para inyector HPI
SCANIA DC12/DT12 - VOLVO - NAVISTAR
CUMMINS ISX/QSX

cm1521-2820



Scania
1932820
1933246
1889112
1794862

Kit de reparación externa DMB para inyector XPI ISX
SCANIA R450/R550 - DC09/DC13/DC16 - P/G/R/T
CUMMINS ISX15

cm2571-1245



FM 152/101

Cód. Originales
Scania
1421174
ED3087316
Cummins
3348004



FM 152/102

Cód. Originales
Scania
1434707
Cummins
4006962



cm2571-1237

Código original kit Scania
1441237

Cód. Originales
Cummins
1- 3867654 (Negro)
2- 4010577 (Verde)
3- 4307148 (Arandela)
4- 3347939 (Amarillo)
5- 3347937 (Violeta)



cm2571-1240

Kit completo o'rings, arandela, espiga, retén y filtros para inyector ISX/QSX sistema HPI

SCANIA DC12/DT12 - VOLVO - NAVISTAR

REPUESTOS

tg6750-3B



Scania
1371788
1503113 VKM
1493670 VKM CV 56001
1545982
1459988

Tensor

SCANIA 114 DSC/DC 11/124 DC12/DT12/144 DSC14
BUS K/L/N 94 DC9/BUS K 114/K 124 DC11/DC12

tg6750-10B



Plano
96 x 32 x 10

Scania
1514086
1353717
1428940
VKM
CV 56002

Tensor

SCANIA 114 DC11/DSC11/124 DC12/144 DSC14
BUS K/L/N 94, K114, K124

tg6750-41B



Scania
1514087
1413609
1428941
VKM
VKM CV 56003

Tensor

SCANIA 114 DC11, 124 DC12, BUS K/L/N94

tg6750-41B



Scania
1514087
1413609
1428941
VKM
VKM CV 56003

Tensor

SCANIA 114 DC11, 124 DC12, BUS K/L/N94

tg6750-42B



Scania
1512749
1795775
1858885
VKM
VKM CV 56007

Tensor

SCANIA 4/P/G/R/T SERIES (D9/D11/D12/D13
DC9/DC11) BUS 4/F/K/N SERIES (DC9)

tg6750-47B



Scania DAYCO
1858884 APV1119
1510698 FEBI
1795774 23296
SKF INA
VKM CV 56008 532045210

Tensor

SCANIA 4/P/G/R T SERIES
BUS 4/F/K/N SERIES DC9

tg6750-56B



Scania
1779757 SKF
1870553 VKM CV 56011
2192038 APV2729
2197391

Tensor

SCANIA SERIE 5 PGR D13

tg6750-58B



Plano
74 x 32

Scania
1859654/R

Polea reparación

SCANIA SERIE 4 114 C/340-380 - SERIE 4 124 C/360-400
SERIE P P380/470 - SERIE R R/340 R/380 - SERIE G G/420

tg6750-59B



Scania
1860734
2089431
2129402
SKF
VKM CV 56012

Rueda tensora

SCANIA P/G/R/T 9.0 - 16.4 09.07

tg6750-62B

REPUESTOS



Scania
1512181
1774654
1859657
1774650
Dayco
APV1120

INA

534009220

Tensor

SCANIA K 124 SERIE 5 P.G.R
MOTOR DC9 / DC12 / DC11 / DT12

MTI 5507

Ø89x140



4 CAPAS
2 ANILLOS
Scania
525050, 488368
390581, 1736053
1851981

Fuelle Intercooler

SCANIA T/R/K112/113/142

MTI 5508

Ø66x75



4 CAPAS

Scania
375527
1347080

Manguera Admisión Turbo

SCANIA T/R112/113/142

MTI 5510

Ø89x140

C/FLÚOR



4 CAPAS
2 ANILLOS

Scania
488368

Fuelle Intercooler

SCANIA T/R/K 112/113

MTI 5531

Ø45/55x70

SILICONA



4 CAPAS

Scania
241805

Reducción Radiador Inferior

SCANIA

MTI 5538

Ø15x105/55

SILICONA



4 CAPAS

Scania
267460
34821428

Caño refrigeración Tapa Compresor

SCANIA

MTI 5539

Ø30x383



4 CAPAS

Scania
2701142

Fuelle radiador superior

SCANIA BR116-K112

MTI 5540M



4 CAPAS

Scania
382983

Manguera de radiador inferior

SCANIA 113

MTI 5542

Ø55x290



4 CAPAS

Scania
290849

Fuelle radiador inferior

SCANIA TRK112-113

MTI 5543M



4 CAPAS

Scania
382985

Manguera de admision de aire, carcasa de termostato

SCANIA 113

MTI 5557

Ø55x200x90



1 CAPA

Scania
318364

Caño curvo inf. a termostato

SCANIA TR112

MTI 5590

Ø21.5x91.5



4 CAPAS

Scania
397999
1376875

Conexión Turbo Aceite

SCANIA 112/113

MTI 5592

Ø80/100x170



4 CAPAS

4 ANILLOS

Scania

1525145, 1442579
1442567, 1358202
1522011, 1522010
1794725, 1809771

Fuelle Turbo

SCANIA 114 - SERIE 4

MTI 5593

C/FLÚOR

Ø80/100x170



4 CAPAS
4 ANILLOS

Scania
1525145, 1442579
1442567, 1358202
1522011, 1522010
1794725, 1809771

Fuelle Turbo

SCANIA 114 - SERIE 4

MTI 5598

C/FLÚOR

Ø21x80



4 CAPAS

Scania
1433110

Conexion Turbo Aceite

SCANIA 113

REPUESTOS

dmT-4L-A

**4LGZ
TV61**

Referencias

Garret	Borgwarner
465990-0007	185576
Scania	14009880000
250248	Holset
252320	3525150
305720	3525151
510545	
520320	
307371	
537408	
375500	
543063	



SCANIA - DS11 - K111

dmT-GT42-A

**GT4288
S400207
HX50**

Referencias

Garret
703072-0003
703072-0004
452109-0010
Scania
1485645
1485646
Holset
3597654
3597655
3597656
Borgwarner
3591777



SCANIA 124 - DSC12-01

dmT-TA45-A

**TA4516
GT4288
S400201
HX50**

Referencias

Garret
466950-0004
Scania
1489194
1324420
54005201
Borgwarner
313063
174618
Holset
3525517
3537639
3528650
3528651



DSC11-17 / 113-360
DSC11-17 / 112 - DSC11-17 / 114

dmT-TO4E06-A

TO4E06

Referencias

Garret
466616-0011
Scania
1317654
1317660
1317662
1351127
1362027



SCANIA P93 MOTOR DSC9 6 CIL

dmT-TA45-B

TA4536

Referencias

Garret
465213-0001
Scania
1670970
1671731
Schwitzer
170404
Holset
3528018



113-310 DS11-34

dmT-GT42-C

GT4288

Referencias

Garret	Holset
452109-0002	3591775
709574-0004	3591776
Scania	3590421
1485648	3590423
1485646	3591777
1485645	Schwitzer
1423038	174619
1423037	
1423036	
1399269	
1388059	



124 DSC12

dmT-HX55-C

HX55

Referencias

Garret
807067-0002
Scania
1423041
1538372
Holset
4038613
3594236
3594238
3594239
4038616
4038617
4031122
4031341
3597728



SCANIA K/P/R/T 124 / K/G/P/R/T 114/380/420
DC12 EURO 3

REPUESTOS

bcS1314653



Scania
1314653 571689
10575689 575159
1575159 10575159
1571689 10571689

Bomba levanta cabina DMB

SCANIA SERIE 2/SERIE 3

bcS1378531



Scania
1378531
383524
575152
575154

Bomba levanta cabina DMB

SCANIA SERIE 2/SERIE 3

bcS1549740



Scania
1549740
1375497
1349010

Bomba levanta cabina DMB

SCANIA S4 114/S4 124 R

bcS1794907



Scania
1549740
1375497
1349010

Bomba levanta cabina DMB

SCANIA P SERIE 14L/16L/19L/49H - G SERIE 14L/16L/19L/19H
R SERIE 16L/19N/19H/19T

bcW2R2899501A



Scania
1118103
1378524
1378526
1575155

Bomba levanta cabina DMB

SCANIA 113

REPUESTOS

fcS1526571



Scania
1526571
1371207
1851212
2142433

Flexible levanta cabina DMB

SCANIA SERIE 4/SERIE P,G,R,T

fcS1526572



Scania
1526572
1371208
1851213
2142423

Flexible levanta cabina DMB

SCANIA SERIE 4

fcS1526573



Scania
1526573
1426339
2142425
526573

Flexible levanta cabina DMB

SCANIA SERIE 4

fcS2142410



Scania
2142410
1767480
1851249

Flexible levanta cabina DMB

**SCANIA SERIE P,G,R,T/SERIE 3 BUS
SERIE 5/EURO 5/6**



SCANIA

LÍNEA PESADA

Catálogo de tuberías



- Tuberías flexibles y rígidas.
- Lubricación de turbo y descarga.
- Lubricación de aceite.
- Tuberías de inyección convencional y Common Rail.
- Tuberías de inyección para bancos de prueba convencional y Common Rail.
- Tuberías flexibles y rígidas para compresor.
- Tuberías de freno y dirección hidráulica.
- Tuberías de agua.

ATENCIÓN

Sobre presentación de muestra fabricamos todo tipo de tuberías para el automotor.

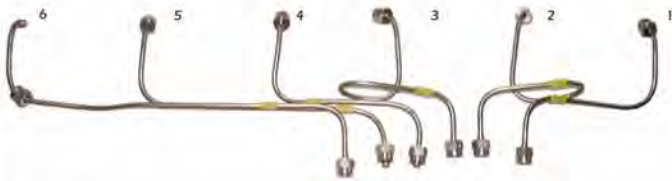

NLS 2

Conjunto de 6 tuberías de inyección

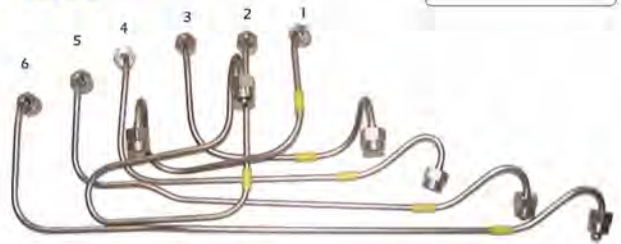
SCANIA B-71/L-71
NLS 3

Conjunto de 6 tuberías de inyección

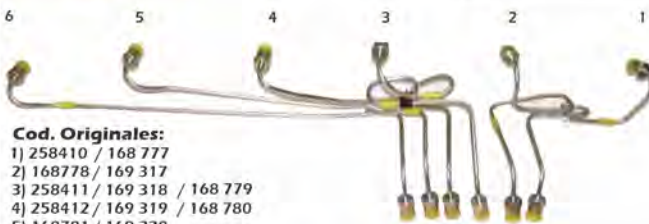
SCANIA B-75/L-75
NLS 4

Cod. Originales:

- 1) 258410 / 168 777
- 2) 168778 / 169 317
- 3) 258411 / 169 318 / 168 779
- 4) 258412 / 169 319 / 168 780
- 5) 168781 / 169 320
- 6) 168782 / 169 321

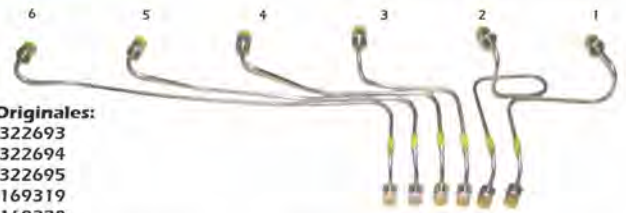
Conjunto de 6 tuberías de inyección

**SCANIA 111 L/LS/LT 110/TURBO
MOTOR D11/DS11/D11 TURBO**
NLS 5

Cod. Originales:

- 1) 322693
- 2) 322694
- 3) 322695
- 4) 169319
- 5) 169320
- 6) 169321

Conjunto de 6 tuberías de inyección

SCANIA 111 SIN TURBO MOTOR D11
S 6
Motor: DS 11
S 6 JA
Motor: DS 11 (Juego armado)
S 6 - AJA
1er Tramo (1 - 2 - 3)
S 6 - BJA
2do Tramo (4 - 5 - 6)
Cod. Original:

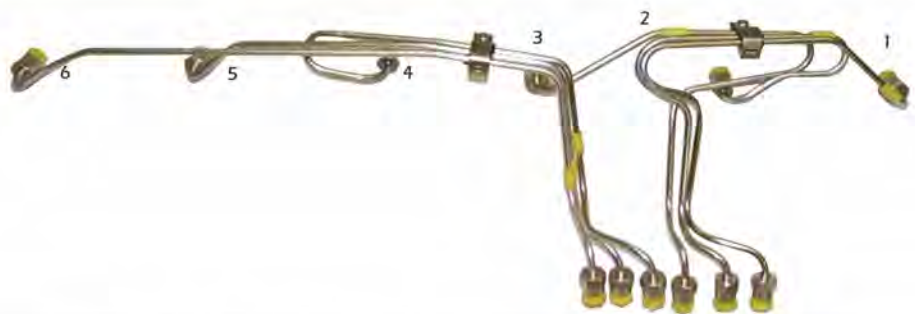
- 1) 312 217
 - 2) 312 218
 - 3) 312 219
- 1er. tramo (289 898)
- 4) 312 221
 - 5) 312 222
 - 6) 312 223
- 2do. tramo (289 899)



Conjunto de 6 tuberías de inyección

SCANIA 112 T/R/M/H/HS/E/ES
S 7
Motor: DS 11
S 7 JA
Motor: DS 11 (Juego armado)
S 7 - AJA
1er Tramo (1 - 2 - 3)
S 7 - BJA
2do Tramo (4 - 5 - 6)
Cod. Original:

- 1) 365 485
 - 2) 365 486
 - 3) 365 487
- 1er. tramo (365484)
- 4) 365 489
 - 5) 365 490
 - 6) 365 491
- 2do. tramo (365488)



Conjunto de 6 tuberías de inyección

SCANIA VABIS H113 T/R/OMNIBUS K 113 TURBO

NLS 8

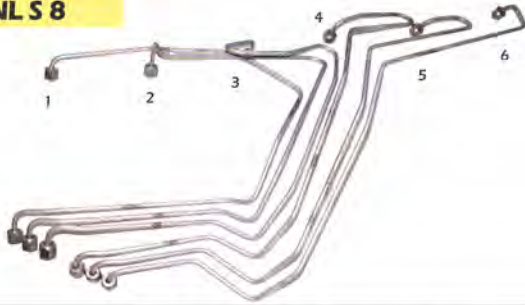

Conjunto de 6 tuberías de inyección

SCANIA P-94

NLS 9



Cod. Original:
 N°1) 137.5369
 N°2) 137.5370
 N°3) 137.5371
 N°4) 137.5372
 N°5) 137.5373
 N°6) 137.5374

Conjunto de 6 tuberías de inyección

SCANIA P124/K124 MOTOR DSC-12

NLS 10

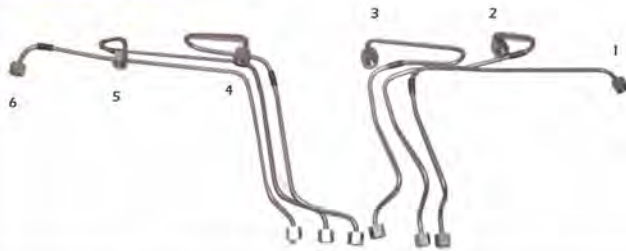

Conjunto de 6 tuberías de inyección

SCANIA P-93

NLS 11



Cód. Original
 N°1 y N°2 1391911
 N°3 y N°4 1391914
 N°5 y N°6 1391917
 N°7 y N°8 1391920

Conjunto de 8 tuberías de inyección

SCANIA V8 440HP TURBO MOTOR Ds14

NLS 12



Scania
 N°1 1376785
 N°2 1376786
 N°3 1376787
 N°4 1376788
 N°5 1376789
 N°6 1376790

Conjunto de 6 tuberías de inyección

SCANIA 114 MOTOR 320/360 HP DOBLE TAPA DE CILINDROS

MV 8451



Planchuela soporte para tubería de inyección S6JA

SCANIA 112/DS11

MV 2002Scania
540611

Filtro a bomba de alimentación

SCANIA 112**MV 2003**Scania
289898

Rebase de inyector

SCANIA 112**MV 2004**Scania
289899

Rebase de inyectores

SCANIA 112**MV 2009**Scania
173908

Cañería de aspiración

SCANIA 112**MV 2016**Scania
249611

Retorno de combustible

SCANIA L111/BR116**MV 2016-CT**

Retorno de combustible

SCANIA L111/BR116**MV 2018**Scania
249608

Alimentación de combustible

SCANIA L111/BR116**MV 2038**Scania
225846

Bomba inyectora a tanque

SCANIA 111/112

MV 2046Scania
321464

Retorno de combustible

SCANIA R/K/T 112**MV 2052**Scania
313748

Flexible de gasoil

SCANIA 112**MV 2055**Scania
306242

Flexible de retorno de gasoil

SCANIA 112**MV 2056**Scania
313619

Caño rígido ojal a ojal

SCANIA**MV 2057**Scania
1110918

Retorno de inyectores

SCANIA 112/113**MV 2072**Scania
1673295

Bajada de retorno de inyectores

SCANIA 113**MV 2076**

Limitador de humo K112/113 de bomba inyectora a admisión

SCANIA

MV 0635A

240 mm



Tubería universal de Manómetro

VARIOS

MV 0635B

1115 mm



Tubería universal de Manómetro

VARIOS

MV 0635C

800 mm



Tubería universal de Manómetro

VARIOS

MV 0635D

410 mm



Tubería universal de Manómetro

VARIOS

MV 0635E

630 mm



Tubería universal de Manómetro

VARIOS

MV 0635F

340 mm



Tubería universal de Manómetro

VARIOS

MV 0635G

200 mm



Tubería universal de Manómetro

VARIOS

MV 2005A



Scania
239573

Reemplaza al
MV 2005

Lubricación de balancines

SCANIA L111/BR116

MV 2005B

Lubricación de balancines. Con tuerca y virola

SCANIA L111/BR116**MV 2006A**Scania
306278

Engrase de grapodina de embrague

SCANIA**MV 2006B**Scania
Reforma
306278

Engrase de grapodina de embrague

SCANIA**MV 2006A-CT**

Engrase de grapodina de embrague

SCANIA**MV 2006B-CT**

Engrase de grapodina de embrague

SCANIA**MV 2012**Scania
1108576

Lubricación de balancines

SCANIA 113**MV 2019**Scania
1673085

Lubricación de turbo

SCANIA 113**MV 2020**Scania
1672878

Retorno de aceite de turbo

SCANIA 112/113

MV 2022



Scania
214552

Engrase de grapodina de embrague

SCANIA 111

MV 2022CT



Engrase de grapodina de embrague con tuercas

SCANIA 111

MV 2023



Scania
242508

Rígido para varilla medición de aceite

SCANIA 111

MV 2028



Rígido para lubricación de turbo

SCANIA

MV 2029



Scania
312839

Lubricación de turbo

SCANIA 112

MV 2030



Lubricación de turbo

SCANIA

MV 2033

Lubricación compresor L111 - BR116

Cod.Orig. 811 177

MV 2037

Flexible de lubricación

Cod.Orig. 811 178

MV 2045

Flexible de rebatimiento de cabina L112

Cod.Orig. 305 525

MV 2047

Flexible de rebatimiento de cabina - 112/113



SCANIA

MV 2033CT

Lubricación compresor L111 - BR116

MV 2037CT

Flexible de lubricación

MV 2045CT

Flexible de rebatimiento de cabina L112

MV 2047CT

Flexible de rebatimiento de cabina - 112/113

con tuerca



SCANIA

MV 2050



Scania
Reforma
306278

Lubricación de turbo

SCANIA

MV 2051



Scania
Reforma
306278

Rigido y flexible de aceite en teflón

SCANIA

MV 2059



Caño de aceite

SCANIA 113

MV 2060



Scania
167709

Rigido para lubricación de turbo

SCANIA

MV 2061



Scania
232136

Rigido lubricación bomba inyectora

SCANIA 111

MV 2067



Scania
1530826

Retorno de aceite al turbo

SCANIA SERIE 4 124

MV 2067A



Scania
1471951
1445502
1433108

Tubería rígida corta, descarga de aceite del turbo

SCANIA SERIE 4 124

MV 2067KIT



Scania
1422385
1352984

Kit descarga de aceite del turbo

SCANIA SERIE 4

MV 2068Scania
1477190

Lubricación de turbo

SCANIA 124 330HP**MV 2069**Scania
1672871

Lubricación/Filtro a carter corto

SCANIA 112/113**MV 2070**Scania
312838

Lubricación compresor

SCANIA 112/113**MV 2071**Scania
1678336

Lubricación compresor

SCANIA 112/113**MV 2008**Scania
417888

Estabilizador de dirección, entrada a caja

SCANIA 113**MV 2011**Scania
814354

Tubería flexible de compresor. Largo 720mm

SCANIA 112/113

MV 2013

MV 2021

Scania
147888 (2013)
300957 (2021)

Lubricación compresor

SCANIA 111

MV 2017

Scania
814815

Tubería flexible de freno. Largo 760mm

SCANIA 112/113

MV 2017A

Scania
815152

Tubería flexible de freno. Largo 560mm

SCANIA 112/113

MV 2017CT

Scania
814815

Tubería flexible de freno. Largo 760mm - Con tuercas

SCANIA 112/113

MV 2024

Scania
811229

Tubería flexible de compresor

SCANIA 111

MV 2024CT

Scania
13866375

Tubería flexible salida de compresor

SCANIA 111

MV 2025

Scania
321538

Tubería flexible de freno

SCANIA 111

MV 2025CT



Tubería flexible de freno

SCANIA 111

MV 2031**Scania**
335345

Flexible de dirección hidráulica

SCANIA 112**MV 2034****Scania**
346077

Flexible de dirección hidráulica

SCANIA R112/113**MV 2039****Scania**
213213

Flexible de dirección hidráulica de depósito a bomba

SCANIA 111**MV 2041**

Rígido dirección hidráulica

SCANIA 112**MV 2042**

Flexible dirección hidráulica

SCANIA**MV 2043****Scania**
322567

Flexible dirección hidráulica

SCANIA**MV 2044****Scania**
153050

Flexible dirección hidráulica

SCANIA L111/BR116**MV 2048**

Flexible dirección hidráulica

SCANIA 112

MV 2058Scania
321538

Rigido de dirección hidráulica

SCANIA**MV 2065**

Flexible de dirección hidráulica

SCANIA**MV 2066**Scania
13866375

Flexible de dirección hidráulica de depósito a bomba

SCANIA 114**MV 2081**Scania
1379469

Tubería flexible de dirección hidráulica

SCANIA SERIE 4-94/114/124**MV 2293**Scania
1680398

Tubería rígida circulación de agua con intercooler

SCANIA 113**MV 2294**Scania
334846

Tubería "Bastón" circulación de agua, depósito superior radiador

SCANIA 112/113

MV 2026

Tubería flexible de pulmón de rueda (largo)

SCANIA**MV 2026CT**

Tubería flexible de pulmón de rueda (Largo) con tuerca

SCANIA**MV 2027**

Tubería flexible de pulmón de rueda (Corto)

SCANIA**MV 2027CT**

Tubería de pulmón de rueda (Corto) con tuerca

SCANIA**MV 2032**Scania
811172

Tubería flexible electroválvulas

SCANIA L111**MV 2032CT**

Tubería flexible electroválvulas con tuerca

SCANIA L111**MV 2035**Scania
970914

Tubería flexible delantero

SCANIA**MV 2036**Scania
815446

Tubería flexible de freno delantero

SCANIA

MV 2011

720 mm.

Scania
814354

Tubería flexible de compresor

SCANIA 112/113**MV 2011A**

630 mm.

Scania
814353

Tubería flexible de compresor

SCANIA 112/113**MV 2011B**

560 mm.

Scania
814351

Tubería flexible de compresor

SCANIA 112/113**MV 2011C**

600 mm.

Scania
814352

Tubería flexible de compresor

SCANIA 112/113**MV 2011D**

500 mm.

Scania
814350

Tubería flexible de compresor

SCANIA 112/113**MV 2053**Scania
305632

Rígido del compresor

SCANIA**MV 2054**

Caño del compresor

SCANIA**MV 2062**Scania
305632

Serpentina del compresor

SCANIA 113

MV 2063



Serpentina del compresor

SCANIA 113

MV 2064



Serpentina del compresor

SCANIA 113

MV 3561



Salida del compresor

SCANIA 112

MV 3574



Salida compresor

SCANIA 113

Scania
815462

MV 3577



Scania
1521457
1887055

Tubería flexible compresor

SCANIA SERIE 4

MV 2010



Cañería para agua

SCANIA 112 / 113

MV 2049



Cañería para agua

SCANIA P93 / P94

MV 2090



Scania
1901729
2145694

Tubería flexible refrigeración de purga de aire

SCANIA SERIE 5 D13 PDE P/G/R/T MOTOR 12.0

MV 2091



Scania
1507014
1483544
106898

Tubería flexible refrigeración de agua de tapa - 6 cilindros

**SCANIA SERIE 5 D13 PDE P/G/R/T MOTOR 12.0
P270/P310/P340/P380/P420/G340/G380/G420**

MV 2092



Scania
1507013
508495

Tubería flexible refrigeración de agua de tapa - 5 cilindros

SCANIA SERIE 5 D13 PDE P/G/R/T MOTOR 12.0

MV 2093



Scania
2354575

Flexible de refrigeración de tapa 6 cilindros

SCANIA L/P/G/R/S - SERIE

MV 3562



Freno neumático

SCANIA 111/112

MV 3575



Flexible freno

SCANIA 113

EX 4



Exhibidor para 4 tuberías

VS

EX 5



Exhibidor para 5 tuberías

VS

EX 6



Exhibidor para 6 tuberías

VS