



Mercedes-Benz

LÍNEA PESADA

Catálogo de productos



- Repuestos de inyección diesel.
- Bombas de combustible.
- Filtros trampa de agua.
- Toberas elementos y válvulas.
- Inyectores.
- Sensores.
- Tensores.
- Mangueras de intercooler.
- Turbos Sobrealimentadores.
- Cajas y flexibles levanta cabina.
- Tuberías rígidas y flexibles.





INDICE

INDICE CON LINEAS DE PRODUCTOS PARA CATÁLOGOS POR MARCAS DE VEHÍCULOS

1- Repuestos, Accesorios y Despiece para Inyección Diesel.

- Abrazaderas
- Anillos de Goma
- Arandelas
- Bombas Alimentadoras
- Bulones Perforados
- Mangueras Universales
- Cebadores
- Electroválvulas
- Filtros
- Juegos de Juntas
- Líquido aditivo Diesel Power
- Prefiltros
- Seguros para Caños de Inyección
- Uniones Orientables
- Válvulas
- Vasos

2- Toberas, elementos y válvulas "DMB" y toberas Common Rail e inyectores

3- Bujías Incandescentes "DMB".

4- Common Rail.

5- Tensores de correa.

6- Turbos "DMB"

7- Tuberías Flexibles y rígidas.

- Para Inyección
- Para Combustible
- Para Aceite
- Para Dirección Hidráulica
- Para Accionamiento de Embrague
- Para Freno Hidráulico
- Para Conducción de Agua y Aire
- Para Aire Comprimido



Guia explicativa uso de catalogo productos CMD.

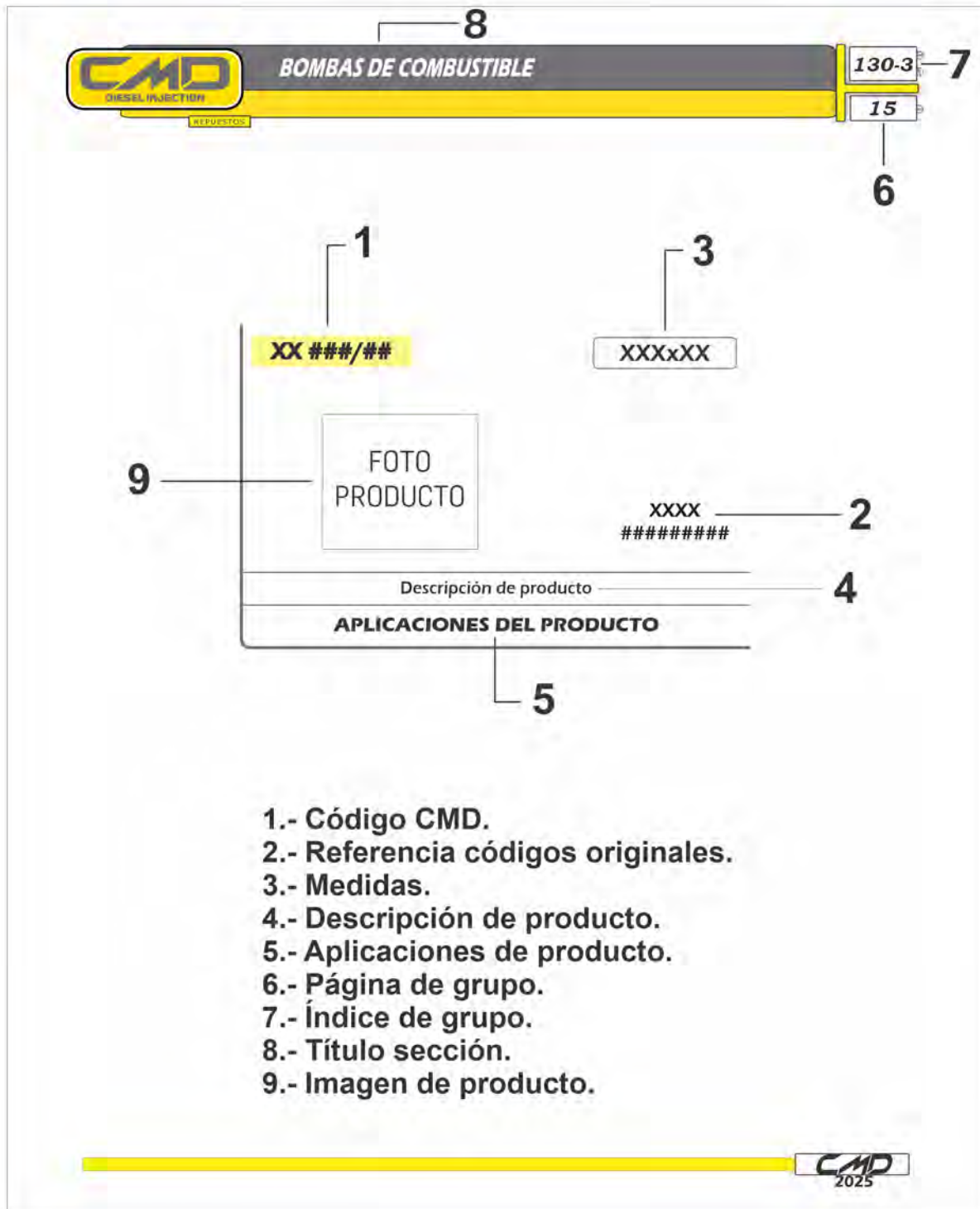

- 1.- Código CMD.
- 2.- Referencia códigos originales.
- 3.- Medidas.
- 4.- Descripción de producto.
- 5.- Aplicaciones de producto.
- 6.- Página de grupo.
- 7.- Índice de grupo.
- 8.- Título sección.
- 9.- Imagen de producto.

Las Marcas y Logos® que aparecen en los catalogos CMD pertenecen a sus respectivos dueños, y cuando son mencionadas estan a titulo informativo.

REPUESTOS

AP 104/40



BOSCH
1 904 711 007

LUCAS
7135-105

Rollo de alambre espiralado

VS

AP 104/40A



Tres tramos de alambre para precintarse de 20 cm cada uno

VS

AP 104/40B



Dos tramos de alambre para precintarse de 20 cm cada uno

VS

AP 104/40C



Un tramo de alambre para precintarse de 20 cm

VS

PLO 166/10



Bosch
1 903 240 000
Lucas/Delphi
5606-62
9009-090

Plomo para precinto

VS

PI 161/100



Pinza sin grabado para plomo precinto

VS

Trazo 1/8" - Color Amarillo

MIA 159/101



Para marcar, numerar y codificar todo tipo de metales, plásticos, maderas, gomas, cerámicas, etc. escribe inclusive sobre superficies aceitosas y rusticas, resiste temperatura e intemperie, provisto en envase de plástico, flexible y anatómico. Color Amarillo, Trazo 1/8"

Contenido Neto **60** cm³

Marcador Industrial - Pintura para Precinto

VS

REPUESTOS

AG 105/1

6 mm



Bosch
2 916 699 083
2 916 693 005
2 916 690 005
2 916 698 053
2 916 699 132

Arandela grower

VS

AG 105/2

8 mm



Arandela grower

VS

AG 105/3

10 mm



Arandela grower

VS

AG 105/4

1/2"



Arandela grower

VS

AG 105/5

9/16"



Arandela grower

VS

AG 105/6

16 mm



Arandela grower

VS

REPUESTOS

AG 105/7

6 mm

**Lucas**
9007-200R

Arandela grower para bomba DPC

VS**AG 105/8**

18 mm

**Bosch**
2 916 693 012

Arandela grower para bomba P

VS**AG 105/9**

20 mm

**Bosch**
2 916 693 013

Arandela grower para bomba P

VS**AG 105/10**

14 mm



Arandela grower

VS**AG 105/11**

12 x 17 mm

**Bosch**
1 420 151 001

Arandela grower de Regulador RSV

VS**AG 105/12**

1"

**Bosch**
2 916 699 093

Arandela grower para bomba tipo P

VS

REPUESTOS

CÓDIGO	MEDIDA (mm)	
AL 105/1	4 x 9 x 1.25	○
AL 105/2	5 x 9 x 1.25	
AL 105/2A	5 x 13 x 1.25	○
AL 105/3	6 x 10 x 1.25	
AL 105/3A	7 x 10 x 1.25	○
AL 105/3B	7 x 14 x 1.25	
AL 105/3C	7 x 14 x 2	○
AL 105/4	8 x 13 x 1.25	
AL 105/5	8 x 12x1 (doble)	○
AL 105/6	9 x 14.5 x 1.25	
AL 105/7	10 x 14.5 x 1.25	○
AL 105/8	11 x 17 x 1.25	
AL 105/9	12 x 17 x 1.25	○
AL 105/10	13 x 20 x 1.25	
AL 105/11	14 x 20 x 1.25	○
AL 105/11A	14 x 23 x 1.25	
AL 105/12	15 x 21 x 1.25	○
AL 105/13	16 x 21 x 1.25	
AL 105/13A	16 x 24 x 1.25	○
AL 105/14	17 x 22 x 1.25	
AL 105/15	18 x 23 x 1.25	○
AL 105/15A	19 x 23 x 1.25	
AL 105/15B	18 x 25 x 1.25	○
AL 105/16	20 x 26 x 1.25	
AL 105/17	22 x 28 x 1.25	○
AL 105/18	24 x 30 x 1.25	
AL 105/19	26 x 32 x 1.25	○
AL 105/20	28 x 36 x 1.25	
AL 105/21	30 x 36 x 1.25	○

CÓDIGO	MEDIDA (mm)	
AL 105/22	32 x 40 x 1.25	
AL 105/23	34 x 42 x 1.25	○
AL 105/23A	35 x 41 x 1.25	
AL 105/24	36 x 42 x 1.25	
AL 105/25	38 x 46 x 1.25	○
AL 105/25A	39.5 x 53 x 0.5	
AL 105/26	41 x 45 x 1.25	
AL 105/26A	41 x 55 x 1.25	○
AL 105/26B	41 x 55 x 0.5	
AL 105/27	42 x 49 x 1.25	
AL 105/28	44 x 52 x 1.25	○
AL 105/29	46 x 54 x 1.25	
AL 105/30	52 x 60 x 1.25	○

REPUESTOS

CÓDIGO	MEDIDA (mm)
CO 105/1	4 x 9 x 1.25
CO 105/2	5 x 9 x 1.25
CO 105/3	6 x 10 x 1.25
CO 105/3A	6 x 10 x 1 (doble)
CO 105/3B	7 x 14 x 1.25
CO 105/4	8 x 12.5 x 1.25
CO 105/4A	8 x 11 x 1.25
CO 105/5	8 x 12 x 1 (doble)
CO 105/6	9 x 14.5 x 1.25
CO 105/7	10 x 14 x 1.25
CO 105/8	11 x 17 x 1.25
CO 105/9	12 x 17 x 1.25
CO 105/10	13 x 20 x 1.25
CO 105/11	14 x 20 x 1.25
CO 105/11A	14 x 23 x 1.25
CO 105/12	15 x 21 x 1.25
CO 105/13	16 x 21 x 1.25
CO 105/13A	16 x 24 x 1.25
CO 105/14	17 x 22 x 1.25
CO 105/15	18 x 23 x 1.25
CO 105/16	20 x 26 x 1.25
CO 105/17	22 x 26 x 1.25
CO 105/18	24 x 30 x 1.25
CO 105/19	26 x 32 x 1.25
CO 105/20	28 x 36 x 1.25
CO 105/21	30 x 36 x 1.25
CO 105/22	32 x 40 x 1.25
CO 105/23	34 x 42 x 1.25
CO 105/24	36 x 42 x 1.25

CÓDIGO	MEDIDA (mm)
CO 105/25	38 x 46 x 1.25
CO 105/26	41 x 45 x 1.25
CO 105/27	42 x 49 x 1.25
CO 105/28	44 x 52 x 1.25
CO 105/29	46 x 54 x 1.25
CO 105/30	52 x 60 x 1.25

REPUESTOS

CÓDIGO	MEDIDA (mm)
FI 105/2	5 x 9 x 1.5
FI 105/2A	5 x 12 x 1.5
FI 105/3	6 x 10 x 1.5
FI 105/3A	6.5 x 12.5 x 1.5
FI 105/4	8 x 13 x 1.5
FI 105/6	9 x 14.5 x 1.5
FI 105/7	10 x 14 x 1.5
FI 105/8	11 x 17 x 1.5
FI 105/9	12 x 17 x 1.5
FI 105/10	13 x 20 x 1.5
FI 105/10A	13 x 24 x 1.5
FI 105/11	14 x 20 x 1.5
FI 105/12	15 x 21 x 1.5
FI 105/13	16 x 21 x 1.5
FI 105/13A	16 x 24 x 1.5
FI 105/14	17 x 22 x 1.5
FI 105/15	18 x 23 x 1.5
FI 105/16	20 x 26 x 1.5
FI 105/17	22 x 28 x 1.5
FI 105/18	24 x 30 x 1.5
FI 105/19	26 x 32 x 1.5
FI 105/20	28 x 36 x 1.5
FI 105/21	30 x 36 x 1.5
FI 105/22	32 x 40 x 1.5
FI 105/23	34 x 42 x 1.5
FI 105/24	36 x 42 x 1.5
FI 105/25	38 x 46 x 1.5
FI 105/26	41 x 45 x 1.5
FI 105/27	42 x 49 x 1.5

CÓDIGO	MEDIDA (mm)
FI 105/28	44 x 52 x 1.5
FI 105/29	46 x 54 x 1.5
FI 105/30	52 x 60 x 1.5



REPUESTOS

AH 109/1



Arandela de hierro para precamara
MERCEDES BENZ (Mod. Viejo)

AC 109/4



MERCEDES BENZ 312/321/1112
(Mod. Nuevo)

AH 109/5



Bosch
1410501072
1410501075
MERCEDES BENZ 180D

REPUESTOS

AC 112/7

10 x 20 mm



De cobre
MERCEDES BENZ 1114

AC 112/28

7.5 x 15.5 x 2 mm



De cobre
MAXION ROVER - SPRINTER - VS

AC 112/28A



Mercedes Benz
000 017 0876
De cobre con pestaña. Original
MAXION ROVER - SPRINTER

AC 112/29

7.5 x 15 x 1.5 mm



De cobre para tobera tipo P
VS

AC 112/30

7.5 x 15.5 x 1 mm



De cobre para tobera tipo P
MAXION ROVER

AC 112/31

7.5 x 15.5 x 2.5 mm



De cobre
VS

AC 112/39

10 x 20 x 0.5 mm



De cobre
MERCEDES BENZ OM 447 / 449
1619/1933

AC 112/40

10 x 21 x 2 mm



De cobre
MAXION ROVER - MWM

AC 112/41

10.5 x 22 x 1 mm



De cobre
MERCEDES BENZ

AC 112/43

10.5 x 22 x 2 mm



De cobre
VS

AC 112/50



Bosch
2 430 105 049
Mercedes Benz
906 017 02 60
De cobre
MERCEDES BENZ OM 904 - 906 ELECTRONICO
OM 457 ELECTRONICO

AC 112/54



Bosch
F 00Z W00 003
Mercedes Benz
906 017 08 60
Arandela Buje
MERCEDES BENZ OM 904 / 906 / 457
ELECTRÓNICO

REPUESTOS

AT 113/1



Para caño de inyección completo con goma
MERCEDES BENZ OM 352 / 352A (1114/1517/1518)
MERCEDES BENZ OM 366 / 366A (1215/1315/1420/1620)

AT 113/2



Goma antivibradora para caño
MERCEDES BENZ OM 352 / 352A (1114/1517/1518)
MERCEDES BENZ OM 366 / 366A (1215/1315/1420/1620)

AT 113/3



Mercedes Benz
3640780026
Pastilla distanciadora entre tramos tuberías de inyección
MERCEDES BENZ 710 PLUS / 1621
OM364LA / OM366LA

REPUESTOS

AC 115/1

25.5 x 29.5 x 1.2



Bosch
2 440 105 000
Fiat
760 241

De cobre para tapón bomba alimentadora tipo Bosch

VS

AL 115/1

25.5 x 29.5 x 1.2



De aluminio para tapón bba alimentadora tipo Bosch

VS

AC 115/2

16 x 19



Bosch
1 230 203 001

Para cebador y tapón chico bomba alim. tipo Bosch

VS

AL 115/3

10 x 24



De aluminio para caño flexible compresor. Terminal plano

MERCEDES BENZ

AF 115/22

10 x 24 x 1.5



De fibra para caño flexible

VS

AC 115/24

14 x 18



De cobre, medida original

MERCEDES BENZ

AL 115/25

10 x 20



De aluminio para caño compresor

VS

AL 115/31

14 x 18



Bosch
2 916 710 609

De aluminio, medida original

VS

AL 115/33

14 x 20 x 2



De aluminio

MERCEDES BENZ

AN 115/34



De nylon para cierre filtro

MERCEDES BENZ

AL 115/39

6 x 10 x 2



De aluminio

VS

AL 115/40

8 x 13 x 2



De aluminio

VS

REPUESTOS

AL 115/41

10 x 14 x 2



De aluminio

VS
AL 115/42

12 x 17 x 2



De aluminio

MERCEDES BENZ
AL 115/43

10.6 x 21 x 2



De aluminio

VS
AL 115/102

16x23x2



Arandela de hierro y goma de 16x23x2 para tapon de filtros y varios

MERCEDES BENZ

REPUESTOS

AG 116/7

4 x 10 x 2.6



Arandela de cobre cónica para caño inyección espesor 0.5mm

VS
AG 116/8

4 x 10 x 2.6



Arandela de cobre cónica para caño inyección espesor 0.9mm

VS

REPUESTOS

AB 117/1

	Pulgadas		Milímetros	
	Ø min	Ø max	Ø min	Ø max
AB 117/1	5/16	3/8	8	10
AB 117/2	3/8	1/2	10	12
AB 117/2A	7/16	17/32	11	11.5
AB 117/3	1/2	9/16	12	14
AB 117/4	9/16	5/8	14	16.5
AB 117/5	11/16	3/4	17	19.5

AB 117/2
AB 117/2A
AB 117/3
AB 117/4
AB 117/5

Fleje ancho 9 mm - Espesor 0.5 mm

COMPACTA

REPUESTOS

	Pulgadas		Milímetros	
	Ø min	Ø max	Ø min	Ø max
AB 117/6	5/16	5/8	8	16
AB 117/7	3/8	13/16	10	20
AB 117/7A	1/2	1	12	26
AB 117/8	3/4	1 1/4	20	32
AB 117/9	1 1/4	1 3/4	30	45
AB 117/10	1 9/16	2 1/8	40	55
AB 117/11	2	2 9/16	50	65
AB 117/12	2 3/8	3	60	75

	Pulgadas		Milímetros	
	Ø min	Ø max	Ø min	Ø max
AB 117/13	2 3/4	3 3/8	70	85
AB 117/14	3 1/8	3 3/4	80	95
AB 117/15	3 1/2	4 1/8	90	105
AB 117/16	3 5/16	4 1/2	100	115
AB 117/17	4 5/16	4 15/16	110	125
AB 117/18	5 1/8	5 11/16	130	145



Fleje ancho 8.5 mm - Espesor 0.8 mm

MINI SUPER

	Pulgadas		Milímetros	
	Ø min	Ø max	Ø min	Ø max
AB 117/19	1 3/8	1 3/4	35	45
AB 117/20	1 9/16	2 1/8	40	55
AB 117/22	2 3/8	3	60	75
AB 117/23	2 3/4	3 3/8	70	85
AB 117/24	3 1/8	3 3/4	80	95
AB 117/25	3 1/2	4 1/4	90	105
AB 117/26	3 3/8	4 1/2	100	115

	Pulgadas		Milímetros	
	Ø min	Ø max	Ø min	Ø max
AB 117/27	4 5/16	4 15/16	110	125
AB 117/27A	4 3/4	5 3/8	120	135



Fleje ancho 14.4 mm - Espesor 0.8 mm

SUPER CIERRE RAPIDO

	Pulgadas		Milímetros	
	Ø min	Ø max	Ø min	Ø max
AB 117/29	9/16	3/4	14	20
AB 117/30	5/8	7/8	16	22
AB 117/31	3/4	1 1/8	20	28
AB 117/32	1	1 3/8	25	35
AB 117/33	1 3/16	1 9/16	30	40
AB 117/34	1 3/8	1 3/4	35	45
AB 117/34A	1 1/2	2	38	50
AB 117/35	1 9/16	2 1/8	40	55
AB 117/36	1 3/4	2 3/8	45	60

	Pulgadas		Milímetros	
	Ø min	Ø max	Ø min	Ø max
AB 117/37	2	2 5/8	50	65
AB 117/38	2 3/8	3	60	75
AB 117/39	2 3/4	3 3/8	70	85
AB 117/40	3 1/8	3 3/4	80	95
AB 117/41	3 1/2	4 1/8	90	105
AB 117/42	3 15/16	4 1/5	100	115
AB 117/43	4 5/16	4 15/16	110	125
AB 117/44	5 1/8	5 11/16	130	145



Fleje ancho 14.4 mm - Espesor 0.8 mm

TIPO AMERICANA

	Pulgadas		Milímetros	
	Ø min	Ø max	Ø min	Ø max
AB 117/90	1/4	5/8	6	16
AB 117/91	7/16	13/16	11	20
AB 117/92	1/2	15/16	13	24



Fleje ancho 8 mm - Espesor 0.5 mm

REPUESTOS

	Pulgadas	
	Ø min	Ø max
AB 117/45	9	11
AB 117/46	11	13
AB 117/47	13	15
AB 117/48	15	17
AB 117/49	17	19
AB 117/50	19	21
AB 117/51	21	23
AB 117/52	23	25
AB 117/53	25	27
AB 117/54	27	29
AB 117/55	29	31
AB 117/56	31	33
AB 117/57	33	35
AB 117/58	35	37
AB 117/59	37	41
AB 117/60	41	44
AB 117/61	44	47
AB 117/62	47	50
AB 117/63	50	54
AB 117/64	54	58
AB 117/65	58	62
AB 117/66	62	66



SOPORTAN ALTAS PRESIONES, REUTILIZABLES, CIERRE PERFECTO. SOPORTAN ALTAS TEMPERATURAS, ANTICORROSIVAS, ATÓXICAS. ECONOMÍA DE COSTO, FACILIDAD DE COLOCACIÓN.

PI 161/101



Pinza para abrazaderas plásticas

VS

REPUESTOS

AC 118/1

Ø INT 12 mm



Capuchón de aluminio
Para manguera sintética de Ø 6x10
mas el remallado.

AC 118/2

Ø INT 14 mm



Capuchón de aluminio
Para manguera sintética de Ø 8x12
mas el remallado.

AC 118/3

Ø INT 15.5 mm



Capuchón de aluminio
Para manguera sintética de Ø 9.5x14
mas el remallado.

REPUESTOS

AC 118/4

Ø INT 21.8 mm



Capuchón de aluminio
Para manguera sintética de Ø 14x20
mas el remallado.

AC 118/5

Ø INT 26.5 mm



Capuchón de aluminio
Para manguera sintética de Ø 18x26
mas el remallado.

AC 118/6

Ø INT 23.2 mm



Capuchón de aluminio
Para manguera sintética de Ø 15x22
mas el remallado.

AC 118/7

Ø INT 10.5 mm



Capuchón de aluminio
Para manguera sintética de Ø 5.5x9
mas el remallado.

AC 118/8

Ø INT 20 mm



Capuchón de aluminio
Para manguera sintética de Ø 13x18
mas el remallado.

AC 118/9

Ø INT 17 mm



Capuchón de aluminio
Para manguera sintética de Ø 12.5x17
mas el remallado.

REPUESTOS

AG 122/71

Bosch
1 410 210 053

Para portacojinete

MERCEDES BENZ OM 366 / OM 366A
AG 122/72

Bosch
1 900 210 163

Para portacojinete

MERCEDES BENZ OM 366 / OM 366A
AG 122/73

Bosch
1 410 210 050

Para racord portaválvula bomba tipo "A" Serie D

VS
AG 122/74

Bosch
2 440 210 009

Para perno estanco bombita alimentadora mod. Nuevo

VS
AG 122/75

Bosch
1 900 210 100
2 440 210 002

Para perno estanco bombita alimentadora tipo "A"

VS
AG 122/76

Bosch
1 410 210 001

Para válvula P161/16

VS
AG 122/80

Bosch
2 410 210 014

Para placa acople bomba inyectora - interior

MERCEDES BENZ OM 447 / 449
AG 122/81

Bosch
2 410 210 050

Para porta rulemán interior

MERCEDES BENZ OM 447 / 449
AG 122/82

Para placa de acople bomba inyectora - Exterior

MERCEDES BENZ OM 447 / 449

REPUESTOS

AG 122/82A

Bosch
2 410 210 026

Para placa (aceite) interior chico

MERCEDES BENZ OM 447 / 449
AG 122/86

Bosch
1 480 210 016

Para racord entrada de bbta. De llenado de circuito

VS
AG 122/94

Bosch
1 420 210 022

Acople TPS y tapa gobernador RQV

MERCEDES BENZ OM 366 - VS
AG 122/96

Bosch
2 440 210 010

Para racord tapón con válvula tipo M

MERCEDES BENZ
AG 122/97

Bosch
1 900 210 119
2 440 210 013

Para racord tapón con válvula tipo M

VS
AG 122/98

Bosch
2 440 210 012

Para racord tapón con válvula tipo M

MERCEDES BENZ
AG 122/100



Junta p/vaso decantador de aluminio tipo Racor

VS
AG 122/101

Mercedes Benz
A0169978248

O'ring de Viton grafitado, para camisa de inyector

MERCEDES BENZ 1114/1518/1620
OM352/OM366

REPUESTOS

AG 122/410



Para prolongador de admisión y tapa de admisión

TO4B

REPUESTOS

AG 122/603

Bosch
2 430 210 081

Para inyector electronico Cummins 044512007 / 120120 de vitón

MERCEDES BENZ OM447/M.BENZ 1938 ELEC. (INY. MECÁNICO)
AG 122/603G

Bosch
2 430 210 081

O ring de vitón grafitado para inyector electrónico

MERCEDES BENZ OM447/M.BENZ 1938 ELEC. (INY. MECÁNICO)
AG 122/605



Para monobomba Bosch - Sistema PLD

MERCEDES BENZ OM 904/906 ELECTR.

REPUESTOS

AG 122/606

Para monobomba Bosch - Sistema PLD
MERCEDES BENZ OM904/906 ELECTR.

AG 122/607

Oring viton para canula entre tubo inyector e inyector
MERCEDES BENZ OM904/OM906/OM457

Bosch
 2430210082
Mercedes Benz
 A5419970645

AG 122/607G

Oring viton grafitado para cánula entre tubo inyector e inyector
MERCEDES BENZ OM904/OM906/OM457
CUMMINS - IVECO

GRAFITADO

Bosch
 2430210082
Mercedes Benz
 A5419970645

AG 122/608

Oring viton para iny. mecan.
MERCEDES BENZ
OM904/OM906/OM457 0432193480

Bosch
 A5419970545

AG 122/609

De perno externo monobomba PLD
MERCEDES BENZ OM904/924/925/926

Bosch
 F00HN35985

AG 122/615G

O ring de vitón grafitado para camisa de inyector
MERCEDES BENZ OM904

GRAFITADO

Mercedes Benz
 A5419970745
 A5419970345

AG 122/616

O ring externo para monobomba Bosch OM457
MERCEDES BENZ AXOR MOTOR OM457LA
ACTROS MOTOR OM451

Mercedes Benz
 A0239976548
Bosch
 F00HN35933
DAF: 1351366
Deutz: 4261417

AG 122/617

O ring externo para monobomba Bosch OM457
MERCEDES BENZ AXOR MOTOR OM457LA
ACTROS MOTOR OM451

Mercedes Benz
 A0239976448
Bosch
 F00HN35932
DAF: 1351366
Deutz: 4261416

REPUESTOS

BP 129/1

8 x 1 x 17 mm



Para descarga de inyector
MERCEDES BENZ - VS

Bosch
 2911235700
 2433456035
Lucas / Delphi
 7169-60

BP 129/6

8 x 1 mm



Doble, para unión descarga
MERCEDES BENZ - VS

BP 129/7

6 x 1 x 15 mm



Para descarga de inyector
MERCEDES BENZ - SPRINTER - VS

Bosch
 2433456034
 2433456020
Cummins
 3905307

BP 129/9

10 x 1 mm



Varias aplicaciones
MERCEDES BENZ - VS

Bosch
 2 911 201 701

BP 129/12

12 mm



Para filtros trampa de agua - Varias Aplicaciones
MERCEDES BENZ - VS

BP 129/16

14 x 1.5 mm



Varias aplicaciones
MERCEDES BENZ - VS

Bosch
 2 911 201 703
Fiat
 705737
Deutz
 111-9243

REPUESTOS

BP 129/16A

14 x 1.5 mm



Mercedes Benz
915036010200

Con 4 agujeros - Para cañería de agua MV 2220A y MV 2220C

MERCEDES BENZ

BP 129/17

14 x 1.5 mm



Deutz
121-6493
Iveco
1570211

Varias aplicaciones

MERCEDES BENZ - VS

BP 129/18

14 mm



Bosch
2 443 456 018
Zexel
152300-0920

Para filtro interior (sin filtro)

MERCEDES BENZ

BP 129/18A

14 x 1,5 mm



Bosch
2 443 456 018
Zexel
152300-0920

Para filtro interior

MERCEDES BENZ - VS

BP 129/20

16 x 1.5 mm



Bosch
2 911 201 705

Aplicaciones varias

MERCEDES BENZ - VS

BP 129/20A

16 x 1.5 mm



Doble p/flexible combustible MV 224 I
MERCEDES BENZ 1634
MOTOR OM 457 ELECTRONICO

BP 129/20D

16x1,5



Mercedes Benz
915036012101
000000004751

Con 4 Agujeros

MERCEDES BENZ

BP 129/21

18 mm



Fiat
746 991

Aplicaciones varias

MERCEDES BENZ - VS

BP 129/22

20 mm



Aplicaciones varias

MERCEDES BENZ - VS

BP 129/23

22 x 1.5



Aplicaciones varias

MERCEDES BENZ - VS

BP 129/24

24mm



Aplicaciones varias

MERCEDES BENZ - VS

REPUESTOS

BA 130/11



Bosch
0440011007

Bombita de llenado de circuito

MERCEDES BENZ - DEUTZ - VS

BA 130/11A



Bosch
0440011009

Bombita de llenado de circuito

MERCEDES BENZ - DEUTZ - SCANIA - FIAT

BA 130/11H



Bosch
0440011010

Bombita de llenado de circuito con cebador de hierro y con resorte

MERCEDES BENZ - DEUTZ - VS

REPUESTOS

BA 130/12



Bosch
0440011011

Bombita de llenado de circuito con pre-filtro
MERCEDES BENZ - DEUTZ - SCANIA - FIAT

BA 130/13



Bosch
42023436

Bombita de llenado de circuito con Racord RAC 173/32
MERCEDES BENZ - DEUTZ - SCANIA - FIAT

BA 130/14



Bosch
0440011002

Bombita de llenado de circuito con racord RAC 173/32
MERCEDES BENZ - DEUTZ OMNIBUS
AP / AH 3.2

BA 130/14A



Bosch
0440011021
Mercedes Benz
0000909250

Bombita de llenado de circuito
MERCEDES BENZ OM457/O500 (LÍNEA NUEVA)
OM457 ELECTRONICO 1634

REPUESTOS

BA 130/21



Bosch
0 440 003 247
0 440 003 240
0 440 003 998
0 440 003 996
FP/KE 22 AD310
FP/KEG 22 AD112/2
FP/KEG 22 AD283/2
Mercedes Benz
000 090 64 50
000 090 10 50
000 090 27 50

Bomba alimentadora con cuerpo de fundición
MERCEDES BENZ MOTOR OM366/366A

BA 130/22



Bosch
0 440 003 176
9 440 030 002
0 440 003 182
0 440 003 184
0 440 003 223
0 440 003 228
0 440 003 186
0 440 003 183
0 440 003 213
0 440 003 232
0 440 003 199
0 440 003 212
0 440 003 233
FP/KE 22 AD 112/2
FP/KE 22 AD 110/2
FP/KE 22 AD 190/2
FP/KE 22 AD 246/2
FP/KE 22 AD 283/2
FP/KE 22 AD 290
FP/KE 22 AD 254/2
FP/KE 22 AD 243/2
FP/KE 22 AD 266/2
FP/KE 22 AD 299
FP/KE 22 AD 249/2
FP/KE 22 AD 265/2
FP/KE 22 AD 301/2

Mercedes Benz
001 091 11 01
001 091 63 01
001 091 141 01

Bomba alimentadora con cuerpo de fundición
MERCEDES BENZ OM352/352A/1114/1518

BA 130/23



Bosch
0 440 003 177
0 440 003 185
0 440 003 190
9 440 030 001
0 440 003 178
0 440 003 180
Mercedes Benz
001 091 15 01
001 091 73 01
001 091 27 01
002 091 60 01
FP/KE 22 AD 240/2
FP/KE 22 AD 247/2
FP/KE 22 AD 223/2
FP/KE 22 AD 218/2
FP/KE 22 AD 241/2
FP/KE 22 AD 198/2

Bomba alimentadora con cuerpo de fundición
MERCEDES BENZ OM360/366

BA 130/24



Bosch
0 440 008 007 - FP/K 22 P9
0 440 008 998 - FP/K 22 P22
0 440 008 029 - FP/K 22 P31
0 440 008 037 - FP/K 22 P39
0 440 008 045 - FP/K 22 P46
0 440 008 048 - FP/K 22 P51
0 440 008 020 - FP/K 22 P22
0 440 008 052 - FP/K 22 P58
0 440 008 993 - FP/K 22 P58
0 440 008 004 - FP/K 22 P6
Mercedes Benz
001 091 67 01
000 090 05 50
001 091 78 01...

Bomba alimentadora para bomba T/P sin filtro
MERCEDES BENZ

BA 130/24P



E/S M14 X 1.5
Bosch
0 440 008 004 FP/K22P6
0 440 008 048 FP/K22P51
Mack (USA)
9350440008004
Scania
523 260
Volvo
240072
Ref. BCD
5008 5004

Bombita alimentadora para bomba T/P con pre-filtro
MERCEDES BENZ 1521/1526

BA 130/25



Bosch
0 440 008 003
0 440 008 999
0 440 008 014
0 440 008 035
0 440 008 046
0 440 008 017
0 440 008 013
0 440 008 040
Mercedes Benz
001 091 61 01
001 091 25 01
000 090 03 50
1/4" x 18 NPTF
FP/K22 P5
FP/K22 P5
FP/KE 22 P18
FP/K22 P 15
FP/K22 P 42

Bombita alimentadora para bomba T/P con pre-filtro
MERCEDES BENZ OM355/OM346

BA 130/28



Bosch
0 440 004 040 - FP/KS 22 AD 23/2
9 440 030 011 - FP/KS 22 AD 48/2
0 440 004 030 - FP/KS 22 AD 22
0 440 004 031 - FP/KS 22 AD 23
0 440 004 059 - FP/KS 22 AD 39/2
0 440 004 054 - FP/KS 22 AD 37/2
0 440 004 066 - FP/KS 22 AD 47
Mercedes Benz
001 091 26 01
352 070 05 03

Bomba alimentadora con cuerpo de fundición
MERCEDES BENZ 608/OM314

BA 130/28



Bosch
0 440 004 040 - FP/KS 22 AD 23/2
9 440 030 011 - FP/KS 22 AD 48/2
0 440 004 030 - FP/KS 22 AD 22
0 440 004 031 - FP/KS 22 AD 23
0 440 004 059 - FP/KS 22 AD 39/2
0 440 004 054 - FP/KS 22 AD 37/2
0 440 004 066 - FP/KS 22 AD 47
Mercedes Benz
001 091 26 01
352 070 05 03

Bomba alimentadora con cuerpo de fundición
MERCEDES BENZ 608/OM314

BA 130/29



Bosch
0440004018
0440004017
9440030003
0440004019
0440004020
0440004027
0440004028
0440004032
0440004033
0440004043
0440004002
Mercedes Benz
0000918401
0000918301
0010910401
0000910001
0000918501
0010911201

Bomba alimentadora con cuerpo de fundición
MERCEDES BENZ

BA 130/29A



Bosch
0 440 080 005
0 440 004 065

Bomba alimentadora con cuerpo de fundición con filtro
MERCEDES BENZ

BA 130/30

PIN 028 - 13.5mm



Bosch
0 440 008 173
0 440 008 074
Mercedes Benz
003 091 06 01
FP/KG 24 P 303

Bomba alimentadora con perno
MERCEDES BENZ OM447/449/1938

BA 130/31



Bosch
0440004018
0440004017
0440030003
Volvo
24138 P3/P4
MWM Diesel
605202000021
905202000021

Bombita alimentadora con cuerpo de fundición
MERCEDES BENZ

REPUESTOS

BA 130/32



Bosch
0440003178
0440003192
0440003226
Deutz
1287477
1301818
3366126

Bombita alimentadora

MERCEDES BENZ

BA 130/35



Bosch
9 440 080 037

Bombita alimentadora

MERCEDES BENZ 1721 OM366 CON BOMBA P

BA 130/36



Bosch
0 440 001 006
0 440 001 007
0 440 001 022
Mercedes Benz
000 091 65 01
FP/K 22 BC 47
FP/K 22 BC 47/2
FP/K 22 BC 135

Bomba alimentadora para bomba T/B sin filtro

MERCEDES BENZ 1721 OM366 CON BOMBA P

BA 130/36P



M14x1.5

Bosch
0 440 001 009 FP/K22BC48
0 440 001 037 FP/K22BC161
0 440 001 038 FP/K22BC175
0 440 001 074 FP/K22BC236/2

Bomba alimentadora para bomba T/B con pre-filtro

**FIAT TIPO "B" - IVECO - MAN - SCANIA
VOLVO 395/495 - DEUTZ**

BA 130/37



Bosch
0 440 007 998
0 440 007 017

Bomba alimentadora

MERCEDES BENZ 220 OM615/616/617 (T/M)

BA 130/38



Bosch
0 440 003 238
0 440 003 245
0 440 003 239
Mercedes Benz
003 091 48 01
FP/KEG 22AD 240/2
FP/KEG 22AD 198/2
FP/KEG 22AD 241/2

Bomba alimentadora

MERCEDES BENZ

BA 130/38A



Bomba alimentadora

**MERCEDES BENZ 710 / 712 / 713
MOTOR OM 364 / 364A**

BA 130/44



Bosch
9440030030
0440004072
0440004073
0440004074
MWM
605202000021
FP/KSG 22 AD 45/2

Bomba alimentadora con perno

**MERCEDES BENZ 710/712/713
MOTOR OM 364/364A**

BA 130/45



Bosch
0 440 004 071
0 440 004 996 FP/KEG 22 AD 281/2
Mercedes Benz FP/KSG 22 AD 23/2
003 091 72 01 FP/KS 22 AD 23/2
000 090 0450
000 090 11 50

Bomba alimentadora con perno

**MERCEDES BENZ OM 364/364A
(MB 709/710/713/812/814) CON PERNO**

BA 130/46



Pin 024-11.5mm

Bosch
0 440 008 076
Mercedes Benz
003 091 42 01
FP/KG 24 P 202

Bomba alimentadora

MERCEDES BENZ

BA 130/48



Pin 024-11.5mm
M14 x 1.5

Bosch
0 440 008 986
0 440 008 078
(Ref BCD:
5208 0078)
Mercedes Benz
000 090 3550
FP/KG 24 P 203

Bomba alimentadora

MERCEDES BENZ

BA 130/49



Pin 028-13.5mm

Bosch
0 440 008 989
Mercedes Benz
000 090 3150

Bomba alimentadora

MERCEDES BENZ OM442

BA 130/50MX



Bosch
0 440 008 131
0 440 008 979
0 440 008 108
FP/KG 24P 311

Bomba alimentadora

MERCEDES BENZ OM366 EPA 94

BA 130/51MX



Bosch
0 440 017 990
0 440 017 043
Mercedes Benz
000 090 7450
FP/KG 24 MW 303

Bomba alimentadora

**MERCEDES BENZ OM366LA
(DESPUÉS DE EPA)**

BA 130/53MX



Bosch **MercedesBenz**
0 440 017 996 (MX) 000 90 22 50
0 440 017 011 002 091 61 01
0 440 017 003
0 440 017 021
Ref.BCD
5017 3003

Bomba alimentadora

**MERCEDES BENZ OM366
(ANTES DE EPA)**

BA 130/54V



M14x1.5

Bosch
0 440 008 008
0 440 008 077
0 440 008 090
0 440 008 114
0 440 008 116
FP/KD 22 P80 - 80I
P89 - P90 - P10 - P85

Bomba alimentadora de cuatro válvulas

MERCEDES BENZ

BA 130/55V



Bosch
0 440 008 015
0 440 008 009
Mercedes Benz
001 091 67 01
000 090 05 50
FP/K 22 P 17
FP/K 22 P 11

Bomba alimentadora

MERCEDES BENZ

BA 130/56V



Roscas Entrada y salida:
14 X 1.5

Bosch
0 440 008 005
0 440 008 028
0 440 008 031
0 440 008 039
0 440 008 053
0 440 008 118
0 440 008 996
FP/KD 22 P30 - P33
P41 - P59 - P91 -
P8 - P32

Bomba alimentadora

MERCEDES BENZ

REPUESTOS

BA 130/57V

1/4 - 18 NPTE

Bosch
 0 440 008 030
Mercedes Benz
 000 090 14 50
 001 091 95 01
 FP/KD 22 P8

Bomba alimentadora

MERCEDES BENZ
BA 130/72

Mercedes Benz
 000 090 6050

Bomba alimentadora

MERCEDES BENZ
BA 130/72A

Mercedes Benz
 000 090 7350

Bomba alimentadora

MERCEDES BENZ
BA 130/83

Bosch **Mercedes Benz:**
 0 440 008 027 001 091 84 01
 0 440 008 994 000 090 21 50
 0 440 008 997 000 090 06 50
 0 440 008 043 002 091 49 01
 FP/K 22 P29
 FP/K 22 P44

Bomba alimentadora

MERCEDES BENZ OM402
OM403 / 1619
BA 130/84

Bosch
 0 440 004 067 FP/KS 22 AD 10
 0 440 004 021 FP/KS 22 AD 10/3
 0 440 004 048 FP/KS 22 AD 10/4
 0 440 004 041 FP/KS 22 AD 10/2
Mercedes Benz Ref. BCD
 000 091 02 01 500 41021

Bomba alimentadora

MERCEDES BENZ

REPUESTOS

BA 130/202

Mercedes Benz
 004 091 05 01
 004 091 04 01
 003 091 74 01
 003 001 99 01

Bomba de combustible

MERCEDES BENZ OM904 / OM906
OM 924 / OM926
BA 130/205

Mercedes Benz
Cod. Actual
 A4570910601
 A4570910101

Cod. Antiguo
 A4570910401
 A4570910201

Bomba de combustible

MERCEDES BENZ OM457 / ATEGO / AXOR
BA 130/205A

Mercedes Benz
 A4570910201

Bomba de combustible

MERCEDES BENZ OM457 / ATEGO / AXOR
BA 130/211

Mercedes Benz
 A0014603080
 A0014605180
 A0024600880
 A0024603980
 A0024600780
 A0034601980
 A0034605080
 A0034603080

Bomba tandem, de combustible y dirección hidráulica

MERCEDES BENZ ACTROS 2040
OM451/OM452

REPUESTOS

0236-2600

Cod. Original
 72103

MAXION

Bomba tandem, de combustible y dirección hidráulica

MERCEDES BENZ SPRINTER

REPUESTOS

CI 131/10



Mercedes Benz
A3520170053

Camisa de inyector

MERCEDES BENZ OM352/352A
OM366/366A

CI 131/12



Mercedes Benz
9060170488
5410170188

Capuchón camisa porta-inyector

MERCEDES BENZ OM904

REPUESTOS

CM 133/1



Bosch
2 447 222 000
Iveco
774 417

Corto

MERCEDES BENZ - VS

CM 133/1AL



Bosch
2 447 222 000
Mercedes Benz
000 091 11 01

Corto (aluminio)

MERCEDES BENZ - VS

CM 133/1R



NP
155200-1120

Corto con resorte tipo Nippon Denso

MERCEDES BENZ - VS

CM 133/2



Bosch
2 447 222 001
Iveco
748 959

Largo

MERCEDES BENZ - VS

CM 133/2R



NP
155200-1120

Largo con resorte tipo Nippon Denso

MERCEDES BENZ - VS

CM 133/7



Bosch
2 447 222 125

Cebador capuchon. Modelo Nuevo

MERCEDES BENZ - VS

CM 133/8



Bosch
2 447 222 099
2 447 010 045

Cebador corto con adaptador

MERCEDES BENZ - VS

REPUESTOS

CF 138/1	5 x 9 mm
CF 138/2	8 x 12 mm
CF 138/3	9,5 x 14 mm
CF 138/7	6 x 10 mm
CF 138/8	13 x 18 mm
CF 138/9	16 x 24 mm

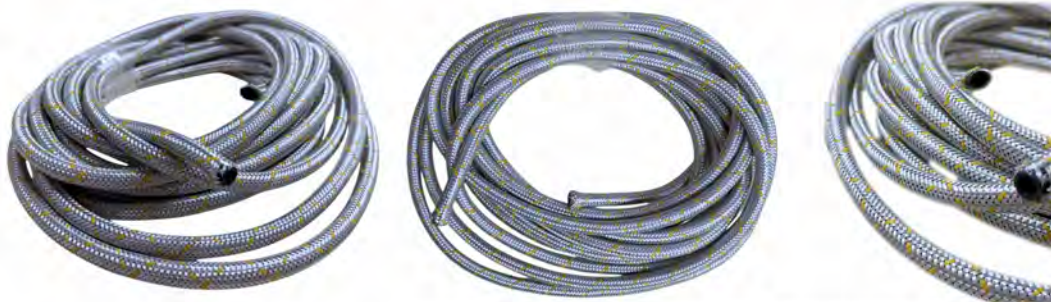
En rollo de 10 metros

REPUESTOS

CC 138/20	3 x 6 mm
CC 138/22	4 x 7 mm
CC 138/23	4 x 8 mm
CC 138/24	6 x 10 mm
CC 138/25	6 x 11 mm
CC 138/26	6 x 12 mm
CC 138/27	7 x 12 mm
CC 138/28	7 x 14 mm
CC 138/29	8 x 12 mm
CC 138/30	8 x 14 mm
CC 138/31	9 x 16 mm

En rollo de 50 metros

REPUESTOS

CH 138/35	3 x 6 mm
CH 138/36	4 x 7 mm
CH 138/37	4 x 8 mm
CH 138/38	6 x 10 mm
CH 138/39	6 x 12 mm
CH 138/40	7 x 11 mm
CH 138/41	7 x 12 mm
CH 138/42	7 x 14 mm
CH 138/43	8 x 14 mm
CH 138/44	9 x 6 mm

En rollo de 50 metros

REPUESTOS

CP 138/50	4 x 6 mm	Retorno de combustible
CP 138/51	6 x 8 mm	Lubricación de aceite
CP 138/52	7 x 10 mm	Combustible
CP 138/53	8 x 11 mm	Aire y Combustible
CP 138/54	9 x 12 mm	Aire
CP 138/54A	11 x 14 mm	Aire
CP 138/55	12 x 16 mm	
CP 138/55B	14 x 18 mm	
CP 138/56	Ø Int 1/4"	
CP 138/57	Ø Int 3/8"	
CP 138/58	Ø Int 1/2"	
CP 138/59	Ø Int 5/8"	



En rollo de 50 metros

REPUESTOS

CT 138/63	3 x 7 mm
CT 138/64	4 x 8 mm
CT 138/65	5 x 9,5 mm
CT 138/66	6 x 12 mm
CT 138/67	7 x 12 mm
CT 138/68	8 x 13 mm
CT 138/69	9 x 15 mm

En rollo de 50 metros

En rollo de 25 metros



REPUESTOS

CG 138/70	3 x 7 mm
CG 138/70A	4 x 8 mm
CG 138/70B	5,5 x 9 mm
CG 138/70C	6 x 12 mm
CG 138/70D	8 x 13 mm



En rollo de 50 metros

REPUESTOS

CD 139/6

Descarga bba. alimentadora curvo con virola de goma

MERCEDES BENZ
CD 139/7

Descarga bba. alimentadora curvo con virola de bronce

MERCEDES BENZ

1/2 x 20

CD 139/8

Descarga bba. aliemntadora recto

MERCEDES BENZ

1/2 x 20

CD 139/10

Para descarga con rulo

MERCEDES BENZ
CD 139/13

Racord para manguera de 6 mm

MERCEDES BENZ
CD 139/14

Racord para manguera de 8 mm

MERCEDES BENZ
CD 139/19

 Macho: M14X1.5
Hembra: M14x1.5

ADAPTADOR

Prolongador para bombita de llenado de circuito universal

MERCEDES BENZ - DEUTZ - SCANIA
CD 139/19A

 Macho: M20x1,5
Hembra: M14x1,5

Conexión prolongador para bomba auxiliar(de llenado de circuito)

MERCEDES BENZ - DEUTZ - SCANIA
CD 139/36

M16x1,5 - 12,5 mm

Mercedes Benz
A9799970172

Conector racord recto con vástago para acople rápido de entrada/salida de filtro trampa de agua

MERCEDES BENZ OM904/ATEGO 1315/1414/1518/1718
OM904LA ACCELO 915C / ACCELO 7DC OM906

REPUESTOS

CI 140/108

Bosch
0430232013
KDAL74S21/19
Mercedes Benz
A0000178821

Cuerpo de inyector completo sin tobera

MERCEDES BENZ OM355 - OM352A / OM366LA
CI 140/110

Bosch
0432 193 480
0431 114 962
0431 114 959
0431 114 945

Cuerpo de inyector completo sin tobera

MERCEDES BENZ OM904/924/926
CI 140/118

Bosch
0432191258-Cuerpo
Mercedes Benz
A0060175121
A0020105051

Cuerpo de inyector completo sin tobera

MERCEDES BENZ AXOR OM457LA EURO 3
ACTROS OM541LA

CI 140/119

Bosch
9430080707
KDEL80P58

Cuerpo de inyector completo sin tobera

MERCEDES BENZ OHL1630 MOTOR
OM447 / OM449LA

REPUESTOS

DI 143/14A



Bosch
9 421 030 549
9 421 030 529
Zexel
155020-2120

Diafragma

MERCEDES BENZ OM 616-180D

DI 143/14B



Zexel
155020-8920
155020-7920

Diafragma

MERCEDES BENZ ELF / DIESEL KIKI

REPUESTOS

EA 145/1

R= 5 X 0.8 mm



Mercedes Benz
000 991 02 20

Tipo A. Rotula punta esferica

MERCEDES BENZ OM314 - 608D

EA 145/2

R= 6 x 1 mm



Cod.Orig.
071805-010202
Mercedes Benz
000 991 02 20

Tipo B. Rotula punta esferica

MERCEDES BENZ OM352 1114

EA 145/3

R= 6 x 1 mm



Mercedes Benz
000 991 24 22

Extremo

MERCEDES BENZ OM352 1517/1518

EA 145/4

R= 6 x 1 mm



Mercedes Benz
300 991 00 22

Extremo

**MERCEDES BENZ OM352/OM364/OM366
366A/1215/ OF 1620**

REPUESTOS

ES 150/21



Evita soldadura

VS

REPUESTOS

EF 150/51



Lucas/Delphi
HDF496
HDF496A
7176-496A

Unidad sellada c/rosca de 16x1.5mm - ac205 para FC 151/40

MERCEDES BENZ

EF 150/54



Mercedes Benz
000 090 11 51
000 092 54 05
001 092 61 01
001 092 61 01 64
352 470 00 92
A 000 090 11 51
A 000 092 27 05
A 000 092 54 05
A 001 092 61 01
A 001 092 61 01 64
A 352 470 00 92

Cartucho filtrante p/vaso de 1/2 litro t/Bosch - ac708m

MERCEDES BENZ OM314/352/366

EF 150/54A



Bosch
945 1037406
F026402012
Mercedes Benz
A0004773515
Mann
P811

Elemento filtrante tipo Bosch 1 litro

MERCEDES BENZ

EF 150/55



A: 109mm
B: 88 mm
C: 101 mm
G: 1" x 12 Hilos
H: Largo 144 mm
Largo con rosca vaso 160 mm

Mercedes Benz
457 09200 01
Racor
R 90-30MB

con rosca para filtro racor - br-90hm - para FC 151/46

MERCEDES BENZ

EF 150/57



A: 109 mm
B: 79 mm
C: 80 mm
G: 1" x 12 Hilos
H: Largo 180 mm
Largo con rosca vaso 193 mm

Racor
R 120-10MB
Mercedes Benz
9794770015

Elemento filtrante tipo Racor para FC 151/48

**MERCEDES BENZ / OM 904 / ATEGO 1315 / 1414 / 1518 / 1718
OM904LA ACCELO 915C / 7DC / OM906**

EF 150/57P



CON VASO PLASTICO

Racor
R 120-10MB

Elemento filtrante tipo Racor para FC 151/48

**MERCEDES BENZ / OM 904 / ATEGO 1315 / 1414 / 1518 / 1718
OM904LA ACCELO 915C / 7DC / OM906**

EF 150/57S



Bosch Fleetguard
0986450727 FS20041
Fram Tecfil
PS10037 PSD4801
DELPHI
EFS108

1"x12UNF

Elemento filtrante DMB, unidad sellada con rosca

**MERCEDES BENZ 1215C 2004/1218 TODOS 2008/1618M 2004/1622L 2004
1634 L/S 2000/1723 L 2004/1938 OM457LA/1944 S 2004/2423/2630/710/712
ATEGO 1418/1725/AXOR1933/2040/2830M457LA/366LA/904LA EURO II/906LA**

EF 150/61



A: 108 mm
B: 78 mm
C: 89 mm
G: 1" x 16 Hilos
H: Largo 200 mm
Largo con rosca vaso: 215 mm

Mercedes Benz
A6884770015KZ
Racor
R120L4MCJA0II

Elemento filtrante tipo Racor - para FC 151/59

**MERCEDES BENZ 710 ELECTRONICO
MOTOR OM364 PLUS**

EF 150/63



Mercedes Benz
A9060900051
A9060920105
A0000901251
A0000901551
A9060920305

Elemento filtrante de combustible PU1046/1x

**MERCEDES BENZ ATEGO/AXOR/ACCELO
OM904/OM906/OM926**

EF 150/65



Mercedes Benz
A3760927201 PS 7171
A3760927301 LANS
Bosch
0986450709 BR60P
Parker
R6010HP
TECFIL
PSD4601

R 1"x14

Elemento filtrante CMD unidad sellada

**MERCEDES BENZ L 1622 DIESEL 1995-2001 - 1218 1998-2000/LAK 1418 1995-2001
OHL1621 1998-2000 - 1214 1995-2001 - OF 1722 2003-2016/LS 1622 1995-2001
L-1620 1999-1992/L-1610 1990-1992 - 1718 K 1996-2000/L-1615 1991-1994
1715 1995-2001/1418 1996-2000**

EF 150/66



Mercedes Benz Volkswagen
A4760927201 2TB127491
Bosch
0986450708 LANS
Parker
R9010HP 6013006035007
Tecfil
PSD4901

R 1"x14

Elemento filtrante CMD unidad sellada

**MERCEDES BENZ 1720A DIESEL 1999-2008/1721 1990-1999/LK2318 1995-2001
LS 1633 1995-2001/L2325 1995-2001/1720 1999-2008/LK 2325 1995-2001
1718 K 1996-2000/LB 2318 1995-2001/1720K 2001-2007/1418 1996-2001
LAK 1418 1995-2001**

EF 150/67



Mercedes Benz
A0004779915KZ
Fleetguard
Fs20222

Elemento filtrante

**MERCEDES BENZ ACTROS/AXOR/ACCELO
ATRON/ATEGO EURO 5**

EF 150/301



Mercedes Benz
A0001420289
Man
US8/1

Elemento filtrante

**MERCEDES BENZ ACTROS/AXOR/ATEGO
ACCELO**

EF 150/302



Mercedes Benz
A0001407078

Kit de reparación Adblue Urea

**1634 L OM457 LA/ACCELO 1016 OM924LA/815 OM 924EV
ATEGO 1418/1419/1725/1726 OM904/906LA
2425/2426 OM906LA/ATEGO/2729 OM926LA**

EF 150/201-R



Mercedes Benz
A0004300969 2992261 81521086001
A0004300669 01907612 81521020008
A0004303395 08123564 81521020009
A0004291097 08190948 81521020010
A0004293695 Renault 81521020013
A0004293795 5000295421 81521020019
A0004293595 5001004902 81521020015
A0004291297 7421267820 82521020013
Scania
5001832112 99100360822
1111131 **Evobus** **John Deere**
1375997 8285141196 A1204884
377640 **Hyundai** **Wabco**
Tecfil 95680 7R000 4324100202
DSF0202 4329980202

Filtro secador de aire de freno DMB - Rosca derecha

**MERCEDES BENZ AXOR/ATEGO/ACTROS MP2
MP3/LK/LN2/MK/SK/NG/ECNIC**

REPUESTOS

FC 151/17



Mercedes Benz
000 092 74 01
001 092 1201
000 092 6801
MWM
9.0541.02.2.0030

Filtro de combustible doble con elementos filtrantes
**MERCEDES BENZ OM 352/352A/366
366A - MWM**

FC 151/17A



Mercedes Benz
001 092 1201
000 092 6801
000 092 74 01
MWM
9.0541.02.2.0030

Filtro completo sin elementos filtrantes
**MERCEDES BENZ OM352/352A/366/366A
MWM**

FC 151/17B



REFORMA
Mercedes Benz
000 092 74 01
MWM
9.0541.02.2.0030

Filtro de combustible doble de unidad sellada
**MERCEDES BENZ OM352/352A/366/366A
VS**

FC 151/18



Filtro completo sin elementos filtrantes
**MERCEDES BENZ UNIMOG
1/2 LITRO**

FC 151/19



Filtro completo, incluye elementos filtrantes
**CUMMINS - SCANIA 9.0L ESTACIONARIOS /11.0L
MERCEDES BENZ 1114 - 1 LITRO**

FC 151/19A



Filtro doble sin elementos de 1 litro
**MERCEDES BENZ OM 447 / OM 449
OMNIBUS 374 - 400 EURO 1 Y 2**

FC 151/20



Filtro trampa de agua universal
UNIVERSAL

FC 151/40



4 salidas con
rosca de 16 mm x 1.5
Filtro trampa de agua tapa simple Reforma
MAXION - MWM - CUMMINS

FC 151/46



Rosca 1" - 12 hilos
Rosca P/Purgador M21 x 1,25 - 6H

Mercedes Benz
4760907452
Racor
690-10HP
Filtro de combustible tipo Racor
MERCEDES BENZ
OMNIBUS 0400/OM364A/904/906/1938 ELECTRONICO

FC 151/46P



Rosca 1" - 12 hilos
Ent y sal M14x1,5

**CON
VASO
PLASTICO**
Mercedes Benz
4760907452
Racor
690-10HP

Filtro trampa de agua tipo racor
MERCEDES BENZ
OMNIBUS 0400/OM364A/904/906/1938 ELECTRONICO

FC 151/47



Rosca 1" - 14 hilos
Rosca P/Purgador M21 x 1,25 - 6H

Scania
523901

Filtro de combustible tipo Racor
MERCEDES BENZ OM366A

FC 151/47A



Rosca 1" - 14 hilos
Rosca P/Purgador M16 x 1,5 - 6H

Scania
523901

Filtro de combustible tipo Racor
**MERCEDES BENZ OM366A
CAMIONES 1620/1218**

FC 151/47P



Rosca 1" - 14 hilos
Rosca P/Purgador M21 x 1,25 - 6H

Scania
523901

Filtro de combustible tipo Racor
MERCEDES BENZ OM366A

FC 151/47AP



Rosca 1" - 14 hilos
Rosca P/Purgador M16 x 1,5 - 6H

**CON
VASO
PLASTICO**

Scania
523901

Filtro de combustible tipo Racor
**MERCEDES BENZ OM366A
CAMIONES 1620/1218**

FC 151/48S



Mercedes Benz
6954700090
9584700090
9584700190
9584700390
Racor
4120-10MB

Filtro de combustible tipo Racor - Elemento sellado sin vaso
**MERCEDES BENZ OM904/ATEGO/1315/1414/1518
1718/OM904LA/ACCELO 915C/7DC/OM906**

FC 151/48

Mercedes Benz
695 470 0090
958 470 0390
958 470 0090
958 470 0190

Racor
4120-10MB



TV 194/48



Tapa para filtro combustible tipo Racor

EF 150/57



Elemento filtrante tipo Racor

Diametro de apoyo filtro:
Ext: 106mm / Int: 75
Rosca Filtro: 1" 12 Hilos
Entrada y Salida: 1 1/2"

Iveco
7146867
Racor
KR27004E

Racor
R120-10MB

VAS 225/19C



Vaso decantador de plástico para filtro Racor

Racor
KR-27004
Mercedes Benz
3760927104
Scania
524014

Filtro de combustible tipo Racor

MERCEDES BENZ OM904/ATEGO 1315/1414/1518/1718/OM904LA ACCELO 915C/ACCELO7DC/OM906

REPUESTOS

FC 151/59



Mercedes Benz
A6884700190

TV 194/53



Mercedes Benz
A6884700190

Tapa filtro trampa de agua tipo Racor

EF 150/61



Mercedes Benz
A6884770015KZ
Racor
R120L4MCJAQII

Elemento para filtro trampa de agua tipo Racor

VAS 225/19M



Mercedes Benz
A6884770007

Vaso para filtro trampa de agua tipo Racor

SEN 226/19M



Mercedes Benz
A6885450024

Sensor de vaso para filtro trampa de agua tipo Racor

Filtro trampa de agua completo para combustible tipo Racor - Bomba electrónica 12 Volt
MERCEDES BENZ 710 ELECTRÓNICO MOTOR OM364 PLUS

REPUESTOS

FM 152/1



Bosch
1450410011

Metálico - De vasito bombita alim. y prefiltro t/ Bosch

MERCEDES BENZ - VS

FM 152/3



Bosch
1450410011

Plástico - de vasito bombita alim. y prefiltro t/ Bosch

MERCEDES BENZ - VS

FM 152/4



Bosch
2440401003

Largo interior bulón para bombita alim. Tipo Bosch

MERCEDES BENZ - VS

FM 152/4P



Plastico interior para bulón
14x1.5mm y 16.15mm

Largo interior bulón para bombita alim. Tipo Bosch

MERCEDES BENZ - VS

FM 152/9



De trampa de agua universal

VS

FM 152/13



Filtro tapón de tanque
MERCEDES BENZ
OM352/352A 1112/114

FM 152/14



R= M14 x 1.5 mm

Filtro tapón de tanque

MERCEDES BENZ OM352/352A - 1114

FM 152/15



R= M16 x 1.5 mm

Filtro tapón de tanque

MERCEDES BENZ OM352/352A - 1114

FM 152/16



Filtro tapón de tanque

MERCEDES BENZ 608

REPUESTOS

FM 152/17

Ø 8 mm

Filtro chupador de tanque mod. Nuevo tipo Siemens

MERCEDES BENZ OM366 - 1215
FM 152/18

Ø 10 mm

Filtro chupador de tanque mod. Nuevo tipo VDO

MERCEDES BENZ OM 366 - 1215
FM 152/19

Filtro de tanque OA 101 Carroceria "EL DETALLE"

MERCEDES BENZ - DEUTZ
FM 152/22

R= M22 x 1.5 mm

Filtro para tanque de aire

MERCEDES BENZ
FM 152/23

Filtro de tanque de aire de freno "VOLTEO"

MERCEDES BENZ

REPUESTOS

IN 154/110A

Mercedes Benz
 A0060178421
Bosch
 0432193436

Inyector DMB calibrado con tobera Bosch 0433175485 DSLA146P1730

MERCEDES BENZ OF1722/1933/ATEGO/AXOR
OM926 LA (EUROIII)
IN 154/110B

Mercedes Benz
 A0060178621
Bosch
 0432193481

Inyector DMB calibrado con tobera Bosch 0433175484 DSLA146P1729

MERCEDES BENZ OF 1218/1518 E3
OM904/OM906
IN 154/110C

Mercedes Benz
 A0060179221
Bosch
 0432193445

Inyector DMB calibrado con tobera Bosch 0433175483 DSLA146P1728

MERCEDES BENZ 2423 OM906 LA
IN 154/110D

Mercedes Benz
 A0030100451
 A0070170121
Bosch
 0432193421
 0432193416

Inyector DMB calibrado con tobera Bosch 0433175489 DSLA160P1786

MERCEDES BENZ ACCELO/AXOR/O500 OM924 LA
ATEGO OM926 LA
IN 154/110E

Mercedes Benz
 A0060171421
Bosch
 0432193480

Inyector DMB calibrado con tobera Bosch 0433175416 DSLA156P1411

MERCEDES BENZ 915C/1117L/1317L/1517L/814L
OM904/OM906
IN 154/110F

Mercedes Benz
 A0060171521
Bosch
 0432193481

Inyector DMB calibrado con tobera Bosch 0433175416 DSLA156P1411

MERCEDES BENZ ATEGO/AXOR/O500 OM906
IN 154/110G

Mercedes Benz
 A0060177521
 A0020109351
 A0020107951
Bosch
 0432193448

Inyector DMB calibrado con tobera Bosch 0433175478 DSLA153P1710

MERCEDES BENZ ACTROS/AXOR/O500 OM906
IN 154/118A

Mercedes Benz
 A0020105051
 A0060175121
 A0070172321
Bosch
 0432191258

Inyector DMB calibrado con tobera Bosch 0433171741 DLLA150P1164

MERCEDES BENZ ACTROS/AXOR/O500
OM457LA/OM541/OM542
IN 154/118B

Mercedes Benz
 A0020104151
 A0060174221
Bosch
 0432191256

Inyector DMB calibrado con tobera Bosch 0433171741 DLLA160P1032

MERCEDES BENZ OM457
IN 154/118C

Mercedes Benz
 A0030100551
Bosch
 0432193419

Inyector DMB calibrado con tobera Bosch 0433175518 DSLA153P5518

MERCEDES BENZ ACTROS/AXOR
OM457

REPUESTOS

JR 155/60



- Ref. 1 1-JUN 156/66A (2 440 109 005)
- Ref. 2 1-FM 152/3 (1 450 410 011)
- Ref. 3 1-RB 180/3 (2 454 642 000)
- Ref. 4 1-VAS 225/21L (2 459 999 002)

Bosch
2 447 010 017

Kit de reparación para bomba alimentadora tipo Bosch con vaso liso

VS

JR 155/61



Bosch
2447010032

Kit vaso plástico modelo nuevo para bombita alimentadora tipo Bosch

MERCEDES BENZ

JR 155/61A



Bosch
2447010035

Kit de filtro, resorte y o-ring para bombita alimentadora tipo Bosch mod. nuevo

MERCEDES BENZ

JR 155/64

Diam. 6 mm



Conjunto de reparación de emergencia para mangueras de poliamida

VS

JR 155/65

Diam. 8 mm



Conjunto de reparación de emergencia para mangueras de poliamida

VS

JR 155/66

Diam. 11 mm



Conjunto de reparación de emergencia para mangueras de poliamida

VS

JR 155/67

Diam. 12 mm



Conjunto de reparación de emergencia para mangueras de poliamida

VS

JR 155/79



- Ref. 1 2-RB 180/4 (2 444 615 006)
- Ref. 2 2-VAL 222/1 (2 443 123 021)
- Ref. 3 2-AC 115/2 (1 230 203 001)

Bosch
2 447 010 011

Kit de reparación para bomba alimentadora tipo Bosch

VS

JR 155/81



- Ref. 1 4-AC 115/24 (2 916 710 610)
- Ref. 2 2-AC 115/2 (1 230 203 001)
- Ref. 3 1-JUN 156/66 (2 440 109 005)
- Ref. 4 1-SV 190/1 (2 444 601 000)
- Ref. 5 3-AG 105/1 (2 916 690 005)
- Ref. 6 1-AG 122/75 (1 900 210 100)
- Ref. 7 1-AC 115/1 (2 440 105 000)
- Ref. 8 2-RB 180/4 (2 444 615 006)
- Ref. 9 2-VAL 222/1 (2 443 123 021)

Bosch
9 441 080 020

Kit de reparación para bomba alimentadora tipo Bosch

VS

JR 155/82



- Ref. 1 4-AC 115/24 (2 916 710 610)
- Ref. 2 3-AG 105/1 (2 916 690 005)
- Ref. 3 2-AC 115/2 (1 230 203 001)
- Ref. 4 2-RB 180/4 (2 444 615 006)
- Ref. 5 2-VAL 222/1 (2 443 123 021)
- Ref. 6 1-JUN 156/66A (2 440 109 005)
- Ref. 7 1-AG 122/75 (1 900 210 100)
- Ref. 8 1-AC 115/1 (2 440 105 000)

Bosch
9 441 080 175

Kit de reparación para bomba alimentadora tipo Bosch

VS

JR 155/83



- Ref. 1 1-JUN 156/66A (2 440 109 005)
- Ref. 2 1-FM 152/1 (1 450 410 011)
- Ref. 3 1-RB 180/3 (2 454 642 000)

Bosch
2 447 010 016
2 447 010 003

Kit de reparación para bomba alimentadora tipo Bosch y prefiltro tipo Bosch

VS

JR 155/84



- Ref. 1 2-AC 115/2 (1 230 203 001)
- Ref. 2 1-AG 122/75 (1 900 210 100)
- Ref. 3 2-VAL 222/1 (2 443 123 021)
- Ref. 4 2-RB 180/4 (2 444 615 006)
- Ref. 5 4-AC 115/24 (2 916 710 610)
- Ref. 6 1-JUN 156/1 (1 411 073 002)
- Ref. 7 1-AC 115/1 (2 440 105 000)
- Ref. 8 1-SV 190/1 (2 444 601 000)

Bosch
2 447 010 004

Kit de reparación para bomba alimentadora tipo Bosch

VS

JR 155/85



- Ref. 7 1-SV 190/1 (2 444 601 000)
- Ref. 8 4-AC 115/24 (2 916 710 610)
- Ref. 9 3-AG 105/1 (2 916 690 005)
- Ref. 10 2-VAL 222/1 (2 443 123 021)
- Ref. 11 2-AC 115/2 (1 230 203 001)
- Ref. 12 2-RB 180/4 (2 444 615 006)
- Ref. 13 1-AC 115/1 (2 440 105 000)

Bosch
2 447 010 004Z

Kit de reparación para bomba alimentadora tipo Bosch

VS

JR 155/86



- Ref. 8 3-AG 105/1 (2 916 690 005)
- Ref. 9 2-VAL 222/1 (2 443 123 021)
- Ref. 10 2-RB 180/4 (2 444 615 006)
- Ref. 11 4-AC 115/24 (2 916 710 610)
- Ref. 12 1-JUN 156/1 (1 411 073 002)
- Ref. 13 1-AG 122/75 (1 900 210 100)
- Ref. 14 1-AC 115/1 (2 440 105 000)

Bosch
2 447 010 004S

Kit de reparación para bomba alimentadora tipo Bosch y prefiltro tipo Bosch

VS

JR 155/87



- Ref. 5 1-SV 190/9 (9 441 080 033)
- Ref. 6 4-AC 115/24 (2 916 710 610)
- Ref. 7 1-TV 194/2 (2 459 999 001)
- Ref. 8 2-BP 129/16 (2 916 710 610)

Bosch
1 457 434 000

Kit de reparación para bomba alimentadora tipo Bosch

VS

JR 155/89



De bba. P. contiene 4 laminas, 4 bujes, y 4 arandelas planas.

MERCEDES BENZ 1526

JR 155/89/AC

ACERO REFORZADO



De bba. P. contiene 4 laminas, 4 bujes, y 4 arandelas planas.

MERCEDES BENZ 1526

JR 155/92



Para tubo de retorno

MERCEDES BENZ

REPUESTOS

JR 155/99

Mercedes Benz
A0000900810
Bosch
2447010024
2447010043

Kit con tapon de 24mm con válvula T/M p/ Bomba Alim.

MERCEDES BENZ
JR 155/99B

Mercedes Benz
A0000900610
Bosch
2447010021

Kit de reparación con válvulas para bomba alim. Tipo Bosch

MERCEDES BENZ
JR 155/103

Kit de reparación de bomba con perno

VS

REPUESTOS

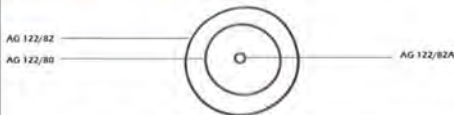
JR 155/310AG

Kit de o'rings para placa portaruleman

MERCEDES BENZ OM447/449 (1633-1639)

REPUESTOS

JUN 156/1

Bosch
1411073002

Para bomba de acople bombita tipo "A"

VS
JUN 156/8

Bosch
1411073000
1411073004

Para base de bomba alimentadora Tipo A mod. Nuevo Angosta

VS
JUN 156/19A

Bosch
A9060910780

Junta para bomba de combustible

MERCEDES BENZ OM904/906/924/926

REPUESTOS

JUN 156/21

De bomba

MERCEDES BENZ 170 - RASTROJERO
JUN 156/22

De bomba

MERCEDES BENZ 3500
JUN 156/23

De bomba

MERCEDES BENZ 1114

REPUESTOS

JUN 156/66A



Bosch
2440109005

De vasito tipo Bosch goma gruesa

VS

JUN 156/78B



Junta para tapón tanque combinada corcho - goma

MERCEDES BENZ

REPUESTOS

JUN 156/310T



Juego de junta para turbo

RANGER/BLAZER/S10/SPRINTER MOT. MAXION 2.5 / APL759/APL821/APL986

JUN 156/352T



Juego de junta para turbo

MERCEDES BENZ 1114/1517/1518 (OM352A) 3LKS/TO4B27/APL956/APL120

JUN 156/355T



Juego de junta para turbo

SCANIA 111/112 - MERCEDES BENZ 1526 OM355/6 TV6114/4LGZ/4LE

JUN 156/364T



Juego de junta para turbo

MERCEDES BENZ 712/914 - OM364A/LA APL400/TA3164/S2AS058/063

JUN 156/366TC



Juego de junta para turbo completo

MERCEDES BENZ 1319/1620/1625 OM366A/LA TO4E66/TO4B81/S2EL169

JUN 156/449T



Juego de junta para turbo

SCANIA 133 - MERCEDES BENZ 1630/1633 OM447/449 TA45/GT45/S400

REPUESTOS

LI 157/11



Mercedes Benz
A 403 016 00 61

Para inyector

MERCEDES BENZ OM 447 / 449 1633 / 1938 / 1941

REPUESTOS

**LA 158/11
COMUN**

**LA 158/11/AC
ACERO
REFORZADO**

Bosch	606904030002
1 410 136 007	Volvo
3 410 190 503	457512

Lamina de acople grande

MERCEDES BENZ 1526
OM 355-5 / OM 355-6

REPUESTOS

PLQ 164/1

20 x 9



Bosch
2430136031
2430136145
2430136161

De inyector

MERCEDES BENZ 3500
PLQ 164/4

22 x 9



Bosch
2 430 136 017
2 430 136 191

De inyector

**MERCEDES BENZ 1114/1518 MOTOR OM 352/OM352A
MERCEDES BENZ 1418/1620 MOTOR OM366/OM366A**
PLQ 164/7

Bosch
2430136212
2430136222
Mercedes Benz
A0040177052

De inyector

MERCEDES BENZ 1933 / 1638
PLQ 164/9

18 x 5



Bosch	M.Benz
2430136166	0010177252
Iveco	Scania
9941816	395767
Deutz	Volvo
1321088	1698513

De inyector

MERCEDES BENZ OM366A C/ TOBERA P422
PLQ 164/16

18 x 7



Bosch
2430136221
F00ZZ20003

De inyector

**MERCEDES BENZ OM 457 ELECTRONICO
904/906/924/926 EURO III**

REPUESTOS

PREF 168/1

Bosch
1 457 434 000

Prefiltro

MERCEDES BENZ - VS
PREF 168/1A

Bosch
2 457 434 009

Prefiltro - Modelo nuevo con vaso plastico

MERCEDES BENZ - VS

REPUESTOS

PT 170/15



Bosch
2 433 317 244

Portatovera

MERCEDES BENZ 1114 / 1517 / 1215
DLA142S1264 - DLA142S1266

PT 170/32



Bosch
2 433 458 117
2 433 458 123

Portatovera

MERCEDES BENZ 220 / 240 / 300 / TD
DN0SD211

PT 170/51



Bosch
2 433 349 465

Portatovera

MAXION INY BOSCH
145P366

PT 170/53



Bosch
2 433 458 154

Portatovera

MERCEDES BENZ 180 MOTOR OM616
DN0SD261

PT 170/55



Bosch
2 433 349 232

Portatovera

MERCEDES BENZ OM352 / 364 / 366
DLA142S1264 - DLA142S1266

PT 170/56



Bosch
2 433 314 143
2 433 314 256

Portatovera

MERCEDES BENZ 1938
DLA130S1253

PT 170/66



Bosch
2 433 349 503

Portatovera para inyector 0432191488/493/503/523
MERCEDES BENZ OM447/449/1938 "EDC"
160P577

PT 170/68



Bosch
2 433 349 122

Portatovera

MERCEDES BENZ 1620 - OM366LA
DLA134P422

PT 170/69



Bosch
2 433 449 434

Portatovera para tobera P

MERCEDES BENZ OM 447 360CV
146P600

PT 170/70



Cód. Original
F00V C14 012

Portatovera para common rail

MERCEDES BENZ OM611 CDI
SPRINTER 311/313/314

PT 170/70A



CON TRATAMIENTO

Cód. Original
F00V C14 012

Portatovera para common rail

MERCEDES BENZ OM611 CDI
SPRINTER 311/313/314

PT 170/71



Bosch
2 433 349 189

Portatovera

MERCEDES BENZ OM904/906
712 / 1115 ELECTRONICO - 156P1411

PT 170/79



Portatovera para inyector Delphi

MERCEDES BENZ 1215
DLA142S1266 - DLA142S1264

PT 170/82



Portatovera p/ inyector 9430080707

MERCEDES BENZ 1634
146P600 - 146P731

PT 170/83



Portatovera

MERCEDES BENZ 1633-1938 ROSCA FINA
DLA130S1253

PT 170/103



Portatovera

MERCEDES BENZ 1620
INYECTOR DELPHI (TOBERA 066)

REPUESTOS

RAC 173/1

6 x 16

Bosch
1 413 462 101

Para purga de aire

MERCEDES BENZ OM 352 - OM 366 - VS
RAC 173/2

6 x 12



Para purga de aire

MERCEDES BENZ - VS
RAC 173/4

De salida TPS

MERCEDES BENZ OM366A
RAC 173/6

15/16 x 1,5 mm



Para caño rígido de tanque

MERCEDES BENZ 1114
RAC 173/32

14/16 x 1,5 mm

Bosch
2 442 457 000

De salida de bomba de llenado

MERCEDES BENZ - VS
RAC 173/33

20x1,5 / 14x1,5



De entrada bomba llenado - Racord reductor

MERCEDES BENZ - VS
RAC 173/38

M22

Bosch
2 443 461 003

Racord tapón con válvula para bomba alimentadora

BOMBAS SCANIA 0 440 008 074
RAC 173/39

M24

Bosch
2 443 461 020
Iveco
9967629
Scania
1374596
Volvo
3094340

Racord tapón con válvula para bomba alimentadora

BOMBAS 0 440 008 072
0 440 008 079 - 0 440 008 089

REPUESTOS

RAC 173/111

Bosch
1 413 372 072

Racord modelo nuevo

MERCEDES BENZ 1114
RAC 173/116

Racord

MERCEDES BENZ 3500 / 170
RAC 173/123

Salida 14mm

Bosch
9 401 083 327

Con válvula

MERCEDES BENZ 1215 OM366/366A

REPUESTOS

RB 180/2

Bosch
2 444 617 010

De botador de bomba alimentadora tipo Bosch (todas)

VS
RB 180/3

Bosch
2 444 615 007
Iveco
772 161

De filtro para vaso de bomba y prefiltro tipo Bosch (todas)

VS
RB 180/4

Bosch
2 444 615 006
Fiat
705 639
Iveco
772 127

De válvula de bomba alimentadora tipo Bosch (todas)

VS

REPUESTOS

RB 181/1



De vástago de filtro 1/2 litro

MERCEDES BENZ

RB 181/8

POR 1 METRO



De acelerador

VS

REPUESTOS

SCI 188/3



De acero y PVC (2 caños)

MERCEDES BENZ - VS

SCI 188/4



De acero y PVC (3 caños)

MERCEDES BENZ - VS

SCI 188/8



3 Caños

MERCEDES BENZ 1114 - VS

SCI 188/9



2 Caños

MERCEDES BENZ 1114 - VS

SCI 188/10



Seguro para 1 tubo de inyección

MERCEDES BENZ OM904/OM906

SCI 188/14



4 Caños

MERCEDES BENZ - VS

Iveco
4734007

SCI 188/15



6 Caños

MERCEDES BENZ - VS

Iveco
4806614

SCI 188/18



5 Caños

MERCEDES BENZ - VS

REPUESTOS

SV 190/1



Bosch
2 444 601 000

Alambre de botador de bombita alimentadora

MERCEDES BENZ

SV 190/9



Bosch
9 441 080 033

Alambre ajuste vaso tipo original

MERCEDES BENZ

SV 190/32



Siemens
X11-800-001-002Z

Seguro de sujeción para inyectores Siemens

VS

REPUESTOS

SO 191/14

12 Volts



Bosch
0330001042

Bomba Bosch VE

MERCEDES BENZ SPRINTER

REPUESTOS

TV 194/1

R= 14 x 1.5



Tapa de prefiltro tipo Bosch modelo nuevo

MERCEDES BENZ

TV 194/2

R= 14 x 1.5



Soporte prefiltro bomba alimentadora tipo Bosch

MERCEDES BENZ

TV 194/8

R = 14 x 1.5



Tapa duofiltro 1/2 litro
MERCEDES BENZ 1114 OM 352/352A
OM366/366A - MWM

TV 194/8A

R = 14 x 1.5



REFORMA
Mercedes Benz

MWM
9 0690 12 5 9207

Tapa duofiltro para unidad sellada
MERCEDES BENZ OM 352/352A
OM 366/366A - VS

TV 194/12

R = 16 x 1.5



Tapa filtro gasoil 1 litro

MERCEDES BENZ

TV 194/13

R = 16 x 1.5



Tapa filtro gasoil 1/2 litro

MERCEDES BENZ

TV 194/15

R = 14 x 1.5



Tapa duofiltro 1/2 litro

MERCEDES BENZ - UNIMO

TV 194/17E

M14 x 1.5



Tapa de filtro vertical

MAXION

TV 194/21

R = 14 x 1.5



Tapa filtro 4 salidas para unidad sellada (reforma)

MAXION

TV 194/35

R = 14 x 1.5



Tapa duofiltro

MERCEDES BENZ OM 447/449 1633/1935
1938/1953 / OMNIBUS 374/409 EURO 1/2

TV 194/44

R = 1" - 12 hilos

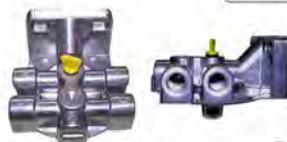

Tapa de filtro de combustible tipo Racor

M.BENZ OMNIBUS 0400/OM364/OM904/906/1938 ELEC.

TV 194/45

R = 1" - 14 hilos



Tapa de filtro de combustible tipo Racor

MERCEDES BENZ OM366A

REPUESTOS

TV 194/45A

R = 1" - 14 hilos

Entrada y salida : M16x1.5

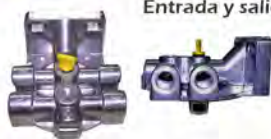

Tapa de filtro de combustible tipo Racor

MERCEDES BENZ
TV 194/48

 Diam. de apoyo filtro: Ext 106mm - Int 75mm
R=1"-12 / Ent. y sal. 16x1,5

Tapa para filtro combustible tipo Racor

 MERCEDES BENZ OM904/ATEGO 1315/1414/1518/1718
OM904LA ACCELO 915C/ACCELO 7DC /OM906

TV 194/53

Bomba electrónica 12 Volt

Mercedes Benz
A6884700190

Tapa para filtro de combustible tipo Racor

MERCEDES BENZ 710 ELECTRÓNICO MOTOR OM364 PLUS

REPUESTOS

TA 195/6

Bosch
2 911 271 703

Ciego de 18mm

MERCEDES BENZ
TA 195/8

Bosch
2 443 462 000

Para válvula de bombita alimentadora

MERCEDES BENZ
TA 195/9

Bosch
2 443 462 014

De resorte émbolo de bombita

MERCEDES BENZ
TA 195/10

Bosch
2 911 271 701

Ciego de 14mm

MERCEDES BENZ
TA 195/19A

16x1,5



Tapón de 16mm con llave Alem para Filtros y varios

MERCEDES BENZ
TA 195/20

Bosch
4 030 700 055
Fiat
46405760

Tapón de último inyector

MERCEDES BENZ
TOR 202/2

Bosch
1 413 453 020

Tipo Bosch con cabeza hexagonal

MERCEDES BENZ - VS
TOR 202/9

Rosca 3/8" x 24h

Perkins
001 901

De filtro, plástico

MERCEDES BENZ - VS
TOR 202/12

Mercedes Benz
376 092 7201
Racor
KR 20017

Purgador para vaso decantador de aluminio tipo Racor

MERCEDES BENZ - VS
TU 210/10

Ø 8,5mm R=14x1,5mm

 Hex 17 mm
Largo 19 mm

Larga

MERCEDES BENZ 1114

REPUESTOS

TU 212/2

6 x 1 mm



Bosch
2 915 011 007
2 423 315 013

Tuerca

VS

TU 212/12

16 x 1.5 mm



Porta conexión para caño de combustible

VS

TU 212/18



Tuerca y terminal para flexible de 16 x1,5mm

MERCEDES BENZ

TU 212/19



Tuerca y terminal para soldar de 16 x1.5mm

MERCEDES BENZ

TU 212/25



Mercedes Benz
403 017 02 71

Tuerca sujeción inyector MB supertorque

MERCEDES BENZ OM 447/OM449

REPUESTOS

TIM 213/1

6 x 1,5 mm



Tubo de inyección. Tira largo de 3 metros

VS

TIM 213/2

6 x 2 mm



Tubo de inyección. Tira largo de 3 metros

VS

TIM 213/3

6 x 3 mm



Tubo de inyección. Tira largo de 3 metros

VS

TIM 213/6

6 x 1,8 mm



Tubo de inyección. Tira largo de 3 metros

VS

REPUESTOS

UN 217/1

8 mm



Unión de acero

VS

UN 217/6

16 mm



PARA MV 2217

Unión orientable 16mm con dos vástagos de 10mm a 180

MERCEDES BENZ OM904/906

REPUESTOS

UN 217/15A

10 mm



Con vástago de 7mm para poliamida de 1/4" (3,35mm)

VS
UN 217/15B

10 mm



Con vástago de 6mm p/manguera o poliamida de 5mm

VS
UN 217/16

12 mm



Con vástago de 7mm p/manguera o poliamida de 1/4" (6,35mm)

VS
UN 217/17

12 mm



Con vástago de 8,5mm p/manguera o poliamida de 8mm

VS
UN 217/18

12 mm



Con vástago de 9,5mm p/manguera o poliamida de 3/8" (8mm)

VS
UN 217/19

13 mm



Con vástago de 7mm p/manguera o poliamida de 1/4" (6,35mm)

VS
UN 217/20

13 mm



Con vástago de 8,5mm p/manguera o poliamida de 8mm

VS
UN 217/21

13 mm



Con vástago de 10mm p/manguera o poliamida de 3/8" (9mm)

VS
UN 217/22

14 mm



Con vástago de 7mm p/manguera o poliamida de 1/4" (6,35mm)

VS
UN 217/23

14 mm



Con vástago de 8,5mm p/manguera o poliamida de 8mm

VS
UN 217/24

14 mm



Con vástago de 10mm p/manguera o poliamida de 3/8" (9mm)

VS
UN 217/24A

14 mm



Con vástago de 11,5mm p/manguera o poliamida de 11mm

VS
UN 217/25

10 mm



Con vástago de 7,5mm p/manguera o poliamida de 1/4" (6,35mm)

VS
UN 217/26

12 mm



Con vástago de 7,5mm p/manguera o poliamida de 1/4" (6,35mm)

VS
UN 217/27

16 mm



Con vástago de 12mm p/manguera o poliamida de 1/2" (12,7mm)

VS
UN 217/28

16 mm



Con vástago de 7mm p/manguera o poliamida de 1/4" (6,35mm)

VS
UN 217/29

16 mm



Con vástago de 8,5mm p/manguera o poliamida de 8mm

VS
UN 217/30

16 mm



Con vástago de 9,5mm p/manguera o poliamida de 3/8" (9mm)

VS

REPUESTOS

UN 217/53

14x10x4mm

Mercedes Benz
 376 990 06 88

De acero para retorno

MERCEDES BENZ OM366 / 366A
UN 217/54

14x10x4mm



De acero para retorno

VS
UN 217/55

10x7x7 mm



De acero para lubricación de bomba inyectora y comp. - 150°

MERCEDES BENZ OM 366
UN 217/56

Mercedes Benz
 376 200 71 52

De acero para refrigeración compresor Wabco

MERCEDES BENZ OM366A /LA/OHL
UN 217/57

Mercedes Benz
 376 200 72 52

Unión doble para base termostato para compresor Wabco

MERCEDES BENZ OM366A /LA/OHL
UN 217/59

12 mm



Entrada y salida de combustible bomba Bosch EP/VA

VS
UN 217/60

1/2 x 20 mm



Entrada de combustible para bomba inyectora DPA Rotodiesel

VS

REPUESTOS

UC 218/PE06 Para Poliamida de 6 mm

UC 218/PE08 Para Poliamida de 8 mm

UC 218/PE10 Para Poliamida de 10 mm

UC 218/PE12 Para Poliamida de 12 mm

UC 218/PE14 Para Poliamida de 14 mm

UC 218/PE16 Para Poliamida de 16 mm

UC 218/PE1/4 Para Poliamida de 1/4"

UC 218/PE3/8 Para Poliamida de 3/8"

UC 218/PE1/2 Para Poliamida de 1/2"

UC 218/PE5/16 Para Poliamida de 5/16"

 Union Conectora para Poliamida
 (TEE - Tubo - Tubo) Modelo PE

VS

UC 218/PU06	Para Poliamida de 6 mm
UC 218/PU08	Para Poliamida de 8 mm
UC 218/PU10	Para Poliamida de 10 mm
UC 218/PU12	Para Poliamida de 12 mm
UC 218/PU14	Para Poliamida de 14 mm
UC 218/PU16	Para Poliamida de 16 mm
UC 218/PU1/4	Para Poliamida de 1/4"
UC 218/PU3/8	Para Poliamida de 3/8"
UC 218/PU1/2	Para Poliamida de 1/2"
UC 218/PU5/16	Para Poliamida de 5/16"



Union Conectora para Poliamida
(Tubo - Tubo) Modelo PU

VS

UC 218/PV04	Para Poliamida de 4 mm
UC 218/PV06	Para Poliamida de 6 mm
UC 218/PV08	Para Poliamida de 8 mm
UC 218/PV10	Para Poliamida de 10 mm
UC 218/PV12	Para Poliamida de 12 mm
UC 218/PV1/4	Para Poliamida de 1/4"
UC 218/PV3/8	Para Poliamida de 3/8"
UC 218/PV1/2	Para Poliamida de 1/2"
UC 218/PV5/16	Para Poliamida de 5/16"



Union Conectora para Poliamida (Tubo - 90°) Modelo Pv

VS

REPUESTOS

VAL 221/2

Bosch
1 457 413 010

Válvula

MERCEDES BENZ - RASTROJERO
VAL 221/6

14 x 1.5

Bosch
1 417 413 000

Válvula

MERCEDES BENZ 1114
VAL 221/7

Válvula de filtro con agujero calibrado

MERCEDES BENZ 1114
VAL 221/12

16 x 1.5 / 18 x 1.5

Mercedes Benz
A9060910224
A0000920810

Válvula de retención de filtro de combustible

MERCEDES BENZ OM904/OM906
VAL 221/17

14 x 1.5

Bosch
1 417 413 047

Válvula

MERCEDES BENZ 1114
VAL 221/18

8 mm



Válvula anti-retorno de entrada y salida recta

VS
VAL 221/19A

10 mm



Válvula anti-retorno de entrada y salida recta

VS
VAL 221/19B

12 mm



Válvula anti-retorno de entrada y salida recta

VS
VAL 221/22

6 mm



Válvula anti-retorno de entrada y salida recta

VS
VAL 221/23A

14 x 1.5

Presión 3.5kg



Válvula de sobre-presion

MERCEDES BENZ 1721 - OM 366 EURO II
MITSUBISHI
VAL 221/24

12 x 1.5

Bosch
1 417 413 046
1 417 413 012

Válvula

MERCEDES BENZ
VAL 221/30

16 x 1.5

Mercedes Benz
A5410700646
A5410700246
A5410700546

Válvula

Om457 ELECTRONICO /0501LA/0502
AXOR/ACTROS
VAL 221/35A

16 x 1.5

MODELO ORIGINAL

Mercedes Benz
9060921210
9060920510

Válvula de descarga

MERCEDES BENZ OM904/906LA
VAL 221/35AF

 MODELO ORIGINAL
CON FILTRO INTERIOR
ITALIANA

Mercedes Benz
9060921210
9060920510

Válvula de descarga

MERCEDES BENZ OM904/OM906

REPUESTOS

VAS 225/21L



Bosch
2 459 999 002

Para prefiltro tipo Bosch liso

MERCEDES BENZ - VS

VAS 225/24



Perkins
002 894

Recto, para prefiltro

MERCEDES BENZ - VS

REPUESTOS

VAS 225/32



De aluminio de 1 litro

MERCEDES BENZ 1633 / 1938
OM447 / OM 449

VAS 225/33



Bosch
2 447 010 015

Para prefiltro tipo Bosch

MERCEDES BENZ - VS

VAS 225/34



Para trampa universal

MERCEDES BENZ - VS

VAS 225/35



Tipo CAV, recto

MERCEDES BENZ - VS

VAS 225/38



Mercedes Benz
000 092 0002

Vaso de gasoil de 1/2 litro

MERCEDES BENZ 1114 / 1517 / 1518
OM352/OM352A

VAS 225/39



Para filtro de 1 litro

MERCEDES BENZ - VS

VAS 225/41



Rosca P/Purgador
M21 x 1,25 - 6H

Scania
524 014
M. Benz
376 092 7104
Racor
KR 27004

Vaso decantador para conjunto filtro tipo Racor

MERCEDES BENZ OM904/906 - VS

VAS 225/41C



Rosca P/Purgador
M21 x 1,25 - 6H

Scania
524 014
M. Benz
376 092 7104
Racor
KR 27004

Contiene: Vaso decantador, o ring y purgador
Vaso decantador para conjunto filtro tipo Racor

MERCEDES BENZ OM904/906 - VS

REPUESTOS

SEN 226/19M



Mercedes Benz
A6885450024

Sensor de vaso para filtro trampa de agua tipo Racor

MERCEDES BENZ 710 ELECTRONICO

REPUESTOS

VAST 227/3

031081

Base perno corto para filtros y trampa de agua

MERCEDES BENZ - VS
VAST 227/4

105363

Base perno largo para filtros y trampa de agua

MERCEDES BENZ - VS

REPUESTOS

tmDN0SD1510

Bosch
0434250011

Tobera

MERCEDES BENZ 170 - 0 430 211 009
KCA 30 SD 2/4

tmDN0SD211

Bosch
0434250009

Tobera

MERCEDES BENZ
3500-312 - 0 430 202 033 KC 60 S D 21/4

tmDN0SD2110

Bosch
0434250012
Nippon Denso
105000-1650

Tobera

MERCEDES BENZ INYECTOR COMPLETO
tmDN0SD220

Bosch
0434250072

Tobera

MERCEDES BENZ 220-240-300 , 0 430 211 041
KCA 30 SD 27/4

tmDN0SD261

Bosch
0434250120

Tobera

MERCEDES BENZ VEH.190D-200D-200TD -
180. 0 430 211 066 KCA 27 S 55

tmDN0SD265

Bosch
0434250128

Tobera

MERCEDES BENZ VEH.250 TD-300TD-250D
0 430 211 053 KCA 30 S 44

tmDN0SD314

Bosch
0434250192/176

Tobera

MERCEDES BENZ C 220 D C-SERIE (T 220 P)
(ORIGEN FRANCIA). 0 430 211 997 KCE 27 S 3

tmDLA130S1253

Bosch
9430084244

Tobera

MERCEDES BENZ 1633/1938 USE 271 486 0 430 233 015
KBAL 80 S 37

tmDLA131S1035

Bosch
0433271486

Tobera

MERCEDES BENZ
1630-1933-1935-1938-1941

tmDLA134P422

Bosch
0433171303

Tobera

MERCEDES BENZ
L 710 C/ OM 364A - 218/1418 C/ OM 366 A
/ 0 431 133 984 KBEL 82 P 18

tmDLA137S1157

Bosch
0433271515

Tobera

MERCEDES BENZ L 914/1114/814 CON MOTOR OM 364 LA -
0 430 232 013 KDAL 74 S 21/19

tmDLA142S1264

Bosch
9430084245

Tobera

MERCEDES BENZ 1114 -1314-1514-608- 911-1112
-1215-1615-1315 0 430 233 015 KBAL80S37

REPUESTOS

tmDLA142S1266**Bosch**
9430084247

Tobera

MERCEDES BENZ 1619-1620 TURBOC/TURBO ZANELLO
- 0 430 232 013 KDAL 74 S 21/19**tmDLA142S926****Bosch**
0433271466/483

Tobera

MERCEDES BENZ
1622 OM 366 LA - 0 431 203 160 KBL 88 S 203/4**tmDLA150S781****Bosch**
0433271394

Tobera

MERCEDES BENZ
1526 - 0 430 232 013 KDAL 74 S 21/19

REPUESTOS

em1418325005**Bosch**
1418325005

Elemento

MERCEDES BENZ
3500 L1112 70MM USE 1 418 325 006 / 020**em1418325096****Bosch**
1418325096

Elemento

MERCEDES BENZ 1114 9MM . 608-L911-L1112

em1418325145**Bosch**
1418325145

Elemento

MERCEDES BENZ
1620-1622-OM 366 IA TURBO**em1418325898****Bosch**
1418325898

Elemento

MERCEDES BENZ
L608/911/1112/1114/8MM USE 1 418 325 899**em2418450069****Bosch**
2418450069

Elemento

MERCEDES BENZ 1926

em2418455016**Bosch**
2418455016

Elemento

MERCEDES BENZ L-1526

em2418455134**Bosch**
2418455134

Elemento

MERCEDES BENZ LS 1633 - LS 1938

em9401083503**Bosch**
9401083503

Elemento

MERCEDES BENZ
LA 1215/1615/L 1619/ 1315 L913 LO 813**emF000401157****Bosch**
F000401157

Elemento

MERCEDES BENZ 2.0 OH 1621 L

REPUESTOS

vm1418522009**Bosch**
1418522009

Válvula

MERCEDES BENZ 3500/RASTROJERO 42/52 HP

vm1418522019**Bosch**
1418522019

Válvula

MERCEDES BENZ 1114 C

vm1418522055**Bosch**
1418522055

Válvula

MERCEDES BENZ 114/EJERC
D 1215/1615 / L 1619 / OH 1319 / 1419

REPUESTOS

vm1418522201



Bosch
1418522201

Válvula

MERCEDES BENZ 1215 MOT.OM 366 P/BBA.
9400084020 MOT. DEUTZ ESTACIONARIO

vm2418552003



Bosch
2418552003

Válvula

MERCEDES BENZ
1521/1926/1618 USE 2 418 522 002

vm2418552005



Bosch
2418552005

Válvula

MERCEDES BENZ
1526 PEGASO 9100/9105 USE 2 418 522 005

vm2418552069



Bosch
2418552069

Válvula

MERCEDES BENZ 1630-1935-1633-1938

vmF000401074



Bosch
F000401074

Válvula

MERCEDES BENZ OF 1620 / 1721 OH 1621
MOTOR OM 366 LA EURO N° BOMBA. F000400002

REPUESTOS

180 D		>>	02/91	bm211A8
180 D		03/91	>>	bm215N4
209 D	OM 617.913	09/82	01/89	bm012MS
322 D	OM 322	01/61	05/64	bm211A8
409 D	OM 617.913	04/82	01/89	bm012MS
190 2.5 TD serie [124]	OM 602.961	09/88	08/93	bm215N4
200 2.0 D serie [124]	OM 601.912 (4 mot. N°009929)	12/84	06/93	bm012M5
200 2.0 D serie [124]	OM 601.912 (4 mot. N°119225)	12/84	06/93	bm012M5
200 2.0 D serie [124]	OM 601.912 (mot. N°009930 4)	12/84	06/93	bm215N4
200 2.0 D serie [124]	OM 601.912 (mot. N°119226 4)	12/84	06/93	bm215N4
250 D serie [124]	OM 602.912 (4 mot. N°018671)	04/85	08/93	bm012M5
250 D serie [124]	OM 602.912 (4 mot. N°1255 58)	04/85	08/93	bm012M5
250 D serie [124]	OM 602.912 (mot. N°018672 4)	04/85	08/93	bm215N4
250 D serie [124]	OM 602.912 (mot. N°125559 4)	04/85	08/93	bm215N4
300 3.0 D serie [124]	OM 603.912 (J mot. N°031254)	01/85	06/93	bm012M5
300 3.0 D serie [124]	OM 603.912 (mot. N°03125 5 4)	01/85	06/93	bm215N4
300 2.5 TD serie [124]	OM 602.962	09/89	08/92	bm215N4
300 3.0 TD serie [124]	OM 603.960 (4 mat. N°017191)	09/86	06/93	bm012M5
300 3.0 TD serie [124]	OM 603.960 (mot. N°-017192 6)	09/86	06/93	bm215N4
250 TD serie [124] mod.T	OM 602.962	09/90	06/93	bm215N4
300 TD serie [124] mod.T	OM 603.912 (4 mot. N°-031254)	09/89	06/93	bm012M5
300 TD serie [124] mod.T	OM 603.912 (mot. N°031255 4)	09/89	06/93	bm215N4
300 TD serie [124] mod.T	OM 603.960 (4 mat. N°-017191)	09/86	06/93	bm012MS
300 TD serie [124] mod.T	OM 603.960 (mot. N°017192 4)	09/86	06/93	bm215N4
190 2.0 D serie [201]	OM 601.911 (4 mat. N°-023517)	09/89	08/93	bm012MS
190 2.0 D serie [201]	OM 60s.9LI (4 mot. N°292357)	09/89	08/93	bm012M5
190 2.0 D serie [201]	OM 601.911 (mat. N°O23518 4)	09/89	08/93	bm215N4
190 2.0 D serie [201]	OM 601.911 (mot. N°292358 4)	09/89	08/93	bm215N4

190 2.5 D serie [201]	OM 602.911 (4 mat. №01452d)	09/88	03/93	bm012MS
190 2.5 D serie [201]	OM 602.911 (4 mot. №071586)	09/88	03/93	bm012M5
190 2.5 D serie [201]	OM 602.911 (mat. №014526 4)	09/88	03/93	bm21SN4
190 2.5 D serie [201]	OM 602.911 (mot. №071587 4)	09/88	03/93	bm215N4
190 2.5 DT serie [201]	OM 602.961	01/88	08/93	bm215N4
C 220 D serie (202)	OM 604.910	08/93	01/95	bm315N5
C 220 D serie [202]	OM 604.910	02/95	06/99	bm415N6
C 220 Cdi serie [202] mod.T	OM 611.960 (4 mot. №30161510)	12/97	02/01	bm615M8
C 220 Cdi serie [202] mod.T	OM 611.960 (4 mot. №50055542)	12/97	02/01	bm615M8
C 220 Cdi serie [202] mod.T	OM 611.960 (mot. №30161511 4)	12/97	02/01	bm615M8
C 220 Cdi serie [202] mod.T	OM 611.960 (mot. №50055543 6)	12/97	02/01	bm615M8
C 220 Cdi serie [203]	OM 611.962	05/00	02/03	bm615M8
C 220 Cdi Sportcoupe serie [203]	OM 611.962	01/01	02/03	bm615M8
C 220 Cdi serie [203] mod.T	OM 611.962	01/01	02/03	bm615M8
C 250 TD serie [202] mod.T	OM 605.960	05/96	02/01	bm415N6
C 250 D serie [202]	OM 605.910	05/93	08/95	bm315N5
C 250 TD serie [202]	OM 605.960	09/95	04/00	bm415N6
C 270 Cdi serie [203]	OM 612.962 (4 mot. №30006560)	12/00	08/04	bm615M8
C 270 Cdi serie [203]	OM 612.962 (mot. N°-3iXl06561 -3•)	12/00	08/04	bm615M8
C 320 Cdi serie [203]	OM 642.910	09/04	05/07	bm533B0
E 250 TD serie [124]	OM 602.962	07/93	06/95	bm215N4
E 250 TD serie [124]	OM 602.962	07/93	06/95	bm215N4
E 300 D serie (124)	OM 606.910	07/93	06/95	bm315N5
E 250 TD serie [124] mod.T	OM 605.911	07/93	05/96	bm315N5
E 220 D serie	OM 604.912			
E 220 D serie [210]	OM 646.961	03/02	>>	bm615M8
E 250 D serie [210]	OM 605.912	06/95	06/99	bm415N6
E 270 Cdi serie (210)	OM 612.961 (6 mot. №30006560)	06/99	03/02	bm615M8
E 270 Cdi serie [210]	OM 612.961 (mot. №30006561 4)	06/99	03/02	bm615M8
E 290 TD serie [210]	OM 602.982	01/96	06/99	bm715N9
E 300 TD serie [210]	OM 606.962	03/97	06/99	bm415N6
E 320 Cdi serie [210]	OM 613.961 (4 mot. №30004179)	06/99	03/02	bm615M8
E 320 Cdi serie [210]	OM 613.961 (mot. №30Ei04180 4)	06/99	03/02	bm615M8
E 270 Cdi serie (210) mod.T	OM 612.961 (6 mot. №30E06560)	06/99	01/03	bm615M8
E 270 Cdi serie [210] mod.T	OM 612.961 (mot. №30006561 4)	06/99	01/03	bm615M8
E 290 TD serie [210] mod.T	OM 602.982	05/96	06/99	bm715N9
E 300 TD serie [210] mod.T	OM 606.962	03/97	06/99	bm415N6
E 320 Cdi serie (210) mod.T	OM 613.961	07/99	01/03	bm615M8
ML 270 Cdi serie [163]	OM 612.963 (6 mot. N-°30E06560)	11/99	06/05	bm615M8
ML 270 Cdi serie [163]	OM 612.963 (mot. №30006561 4)	11/99	06/05	bm615M8

REPUESTOS

ML 350 Cdi serie [164]	OM 642.940	12/09	01/10	bm533B0
ML 400 Cdi serie [163]	OM 628.963	09/01	06/05	bm615M8
S 350 SLD T serie [163]	OM 603.970	03/90	06/91	bm215N4
S 300 TD serie [140]	OM 606.961	06/96	09/98	bm415N6
S 350 TD serie [140]	OM 603.971	06/93	06/96	bm215N4
S 400 Cdi serie [220]	OM 628.960	09/03	08/05	bm615M8
Sprinter 211 2.2 Cdi	OM 611.981 (6 mot. №30161510)	04/Gli	05/06	bm615M8
Sprinter 211 2.2 Cdi	OM 611.981 (6 mot. №50055542)	04/£0	05/06	bm615M8
Sprinter 211 2.2 Cdi	OM 611.981 (mot. №30161511 C)	04/00	05/06	bm615M8
Sprinter 211 2.2 Cdi	OM 611.981 (mot. №50055543 4)	04/Li0	05/06	bm615M8
Sprinter 308 2.2 Cdi	OM 611.987 (6 mot. №30161510)			bm615M8
Sprinter 308 2.2 Cdi	OM 611.987 (6 mot. №50055542)			bm615M8
Sprinter 308 2.2 Cdi	OM 611.987 { mot. №30161511 4)			bm615M8
Sprinter 308 2.2 Cdi	OM 611.987 (mot. N°-5D055543 -3•)			bm615M8
Sprinter 311 2.1 Cdi	OM 611 LA			bm615M8
Sprinter 311 2.2 Ccli	OM 611 LA	06/01	12/04	bm615M8
Sprinter 312 2.5 TD	Maxion OM 014A			bm814N0
Sprinter 313 2.2 Cdi	OM 611 LA	06/01	>>	bm615M8
Sprinter 413 2.2 Cdi	OM 611 LA	06/01	>>	bm615M8
Viano 2.2 Cdi	OM 646 DE22LA (MOC3) - OM 646.f	09/03	>>	bm615M8
Vito 2.2 D	OM 601.942	11/95	09/OK	bm215N4
Vito 2.2 Cdi	OM 611.980 (6 mot. №30161510)	04/99	09/03	bm615M8
Vito 2.2 Cdi	OM 611.980 {6 mot. №50055542)	04/99	09/03	bm615M8
Vita 2.2 Cdi	OM 611.980 (mot. №30161511 4)	04/99	09/03	bm615M8
Vito 2.2 Cdi	OM 611.980 (mot. №5fXi5SS43 4)	04/99	09/03	bm615M8

REPUESTOS

<p>ssA0001400030</p>  <p>Mercedes Benz 0001400030</p> <p>Calentador DMB difusor inyector de adblue</p> <p>MERCEDES BENZ ACTROS</p>	<p>ssA0041537028</p>  <p>Mercedes Benz A0041537028 A0041537023 A0041537628 A0061535628 A0101535328</p> <p>Sensor de presión de aire Map DMB</p> <p>MERCEDES BENZ AXOR 1634 OM926 ATEGO OM906</p>	<p>ssA0015425617</p>  <p>Mercedes Benz A0015425617 A0015429017 Volvo 3417000 34170001</p> <p>Sensor de presión de aceite DMB</p> <p>MERCEDES BENZ LS1935 OM366 BUSES 0400 OM447</p>
<p>ssA0041532028</p>  <p>Mercedes Benz A0041532028 A0091534728 Bosch 0281006282 0281002246 0281002247 Cummins 4893926</p> <p>Sensor de presión de aire Map DMB</p> <p>MERCEDES BENZ ACTROS OM904/ANTOS OM924 AROCS OM906/AXOR OM926</p>	<p>ssA0071530828</p>  <p>Mercedes Benz A0071530828 A0041534928</p> <p>Sensor de presión de aceite DMB</p> <p><small>MERCEDES BENZ ACTROS OM904 LA/ANTOS OM906LA/AROCS OM928 LA AXOR OM926 LA/ATEGO OM470/471 LA/ECONIC OM501/502 LA / BUSES 0500</small></p>	<p>ssA0015457409</p>  <p>Mercedes Benz A0015457409 A0025450209 A0015451709 2004925 4441RHO</p> <p>Sensor interruptor de señal de caja DMB</p> <p>MERCEDES BENZ ATEGO/ATRON ACCELO</p>

REPUESTOS

ssA0015457309



Mercedes Benz
A0015457309
A0015451609
A0015454609
A0025450109

Sensor interruptor de señal de caja DMB

**MERCEDES BENZ ACTROS OM457
AXOR 210 OM926**

ssA0101535328



Mercedes Benz
A0101535328
A0041537628
A0041536128
A0041537028
Bosch
0281006481

Sensor interruptor de señal de caja DMB

**MERCEDES BENZ ACTROS OM457
AXOR 210 OM926**

ssA0101535328



Mercedes Benz
A0011533120
A0011532120
Bosch
0192114011

Sensor de cigüeñal DMB

**MERCEDES BENZ ACTROS (1996-2003) OM904
ACTROS (2003-2008) OM906 / ACTROS (2008-2011) OM924
ACTROS (2011-2020) OM926 / ATEGO (1998-2004) OM457**

ssA9705450124



Mercedes Benz
A9705450124

Sensor nivel liquido refrigerante DMB

**MERCEDES BENZ ACCELO 915/1016 OM924/ACCELO 915 OM904 ATEGO 1418 OM904 -
ATEGO 1419/1725/2425/2426 OM926/ATRON 1624 OM906
ATRON 1634 OM457/AXOR 1933/2035/2831/3131 OM926
AXOR 3340 OM457**

ssA0041537028



Mercedes Benz
A0041537028
A0041537023
A0041537628
A0061535628
A0101535328

Sensor de presión de aire map DMB

**MERCEDES BENZ AXOR 1634 OM926
ATEGO OM906**

ssA0155422417



Mercedes Benz
A0155422417
A0125424817
A0135426217

Sensor de velocidad DMB

**MERCEDES BENZ ATEGO G85/AXOR
G210/G240 - ECONIC/ACTROS**

ssA0031532728



Mercedes Benz **Chrysler**
A0031532728 5080352AA
A0031532828 5080350AA
A6519050000 **Mitsubishi**
Jeep/Dodge MN960274
5080352AA MN960372

Sensor de velocidad DMB

**MERCEDES BENZ C230 1.8L/C240 2.6L/C320/ML320
CLK320/E320 3.2L / ML350 3.7L / S430 4.3L / SL500 5.0L**

ssA0005450527



Mercedes Benz
A0005450527
A0005450427
Jeep/Chrysler/Dodge
05080371AA

Sensor electroválvula DMB

**MERCEDES BENZ
SPRINTER 313/413/611 CDI**

ssA00051531328



Mercedes Benz **Chrysler**
A00051531328 5080346AA
A0031539728 K68407876AA
A0031539726 **Jeep**
Jeep/Dodge 051175762AA
5080346AA

Sensor de árbol de levas DMB

**MERCEDES BENZ SPRINTER 311/413/515 2.2 CDI - CLASE A 140 1.4
140 1.6/190 1.9 - CLASE B 180 1.8 CDI/200 2.0 CDI - CLASE C 200 2.0/270 2.7 CDI
CLASE E 200 2.0/220 2.2/270 2.7 CDI**

ssA9795420318



Mercedes Benz
A9795420318
Volvo
21538791

Sensor de presión de aire MAP DMB

MERCEDES BENZ ATEGO 4.4 L / AXOR 3.2 L

ssA0011532120



Mercedes Benz
A0011532120
A0011533120

Sensor de cigüeñal DMB

**MERCEDES BENZ ACTROS OM457
ATEGO OM904 - AXOR OM906**

ssA0041534228



Mercedes Benz
A0041534228
A0041534328

Sensor de temperatura del refrigerante, interruptor ventilador de radiador DMB

**MERCEDES BENZ ACTROS OM447
ATEGO OM457 / AXOR**

ssA0061534528



Mercedes Benz
0061534528
0061537428
0061537528

Sensor de temperatura

**MERCEDES BENZ EURO 4/5/ACCELO/ATEGO
AXOR/ACTROS/ATRON**

ssA0061537428



Mercedes Benz
A0061537428
A0061537528

Sensor de presión de aceite

MERCEDES BENZ AXOR/ACCELO/ACTROS/ATRON

ssA0061537528



Mercedes Benz
A0061537528
A0051532328
A0061534428

Sensor de presión

**MERCEDES BENZ ACTROS MP2/MP3/AXOR
ATEGO**

REPUESTOS

cm1103-057



Bosch
1465250057
0928400646

Válvula dosificadora de caudal bomba CR

MERCEDES BENZ - MITSUBISHI CANTER 4.9

cm1103-087



Bosch
1465250087
02928400665
0928400719
Mercedes Benz
A6420740284

Válvula dosificadora de caudal de bomba CR

MERCEDES BENZ SPRINTER/VIANO/VITO 3.0

cm1103-612



Mercedes Benz
A6400740084
Bosch
0928400612

Válvula reguladora de presión/unidad de medición

**MERCEDES BENZ A160/A180/A200
2.0 CDI**



VÁLVULAS REGULADORAS DE PRESIÓN DE BOMBAS Y TOBERAS COMMON RAIL



Mercedes-Benz

1103

1

cm1103-661



Mercedes Benz
A6420740184
Bosch
0928400661
0928400677

Válvula reguladora de presión/unidad de medición
MERCEDES BENZ SPRINTER 418
OM642 3.0 CRD

cm1122-163



Bosch
0433175163

Tobera DSLA156P736
MERCEDES BENZ C200 CDI
C220/C270/CLK270/E200/E220



VÁLVULAS REGULADORAS DE PRESIÓN DE RAMPAS (COMMON RAIL)



Mercedes-Benz

1141

01

REPUESTOS

cm1141-003



Bosch
0281002241
Mercedes Benz
6110780149

Válvula reguladora de presión
MERCEDES BENZ SPRINTER 208/211/213/216/308/311/313/316/411/413
416/616 - A160/A170/VANEO 17 C270/C30/CLK270/E270
G270/ML270/E320/S320

cm1141-004



Bosch
0281002698
0281002699
Mercedes Benz
6110780549

Válvula reguladora de presión
MERCEDES BENZ SPRINTER 208/211/213/216/308/311/313/316/411/413
416/616 - A160/A170/C200/C220/C270/C30/CLK270/E200/E220/E400
G400/ML270/ML400/S320/S400/V200/220 -VANEO 17

cm1141-014



Bosch
0281002682
Mercedes Benz
A6480700046

Válvula reguladora de presión de rampa CR 0445214129
MERCEDES BENZ CLS 320/350 E320 ML 320/350 CDI 3.0
SPRINTER 2500/3500

cm1141-016



Bosch
0281002794
0281002795
Mercedes Benz
A6420780149

Válvula reguladora de presión de rampa CR 0445214108
04452141606
MERCEDES BENZ VIANO/VITO/SPRINTER
2.0/2.2



SENSORES DE PRESIÓN COMMON RAIL

1142

01

REPUESTOS

cm1142-671



Bosch
0281002671
0281002672
0281002842
BMW
13537794758
Mercedes Benz
A0041536728
A0061533328
A0061536528

Sensor de presión de rampa CR 0445214096 0445214108
0445214129 0445214148
BMW 745 D - JEEP GRAND CHEROKEE 3.0 CRD
MERCEDES BENZ 2.1/2.2/2.7/3.0/4.0 CRD
OM629/640/642/646/648

cm1142-842



Bosch Mercedes Benz
0281002842 A0041536728
0281002504 A0061533328
0281002505 A0061536528
0281002671
0281002672
0281002843

Sensor de presión de rampa CR 0445214072 0445214160
0445214162
AUDI V6 3.0 TDI - BMW 7 745D 4.4 - JEEP GRAND CHEROKEE 3.0 CRD
MERCEDES BENZ 2.1/2.2/2.7/3.0/3.2/4.0 OM626/629/640
642/646/647/648

cm1142-942



Bosch
0281002942
0281002700
0281002937
0281006022
Mercedes Benz
A0051535828

Sensor de presión de rampa CR
MERCEDES BENZ SPRINTER
311/313/411/413 OM611



ARANDELAS VARIAS (COMMON RAIL)



Mercedes-Benz

1161

01

REPUESTOS

cm1161-004



Bosch
1987972076

Arandela asiento inyector Bosch
MERCEDES BENZ CDI

cm1161-004A



Bosch
1987972076

Arandela asiento inyector Bosch - Plana con muescas
MERCEDES BENZ CDI

cm1161-006

7,5x15x1,5mm



Bosch
F00VC17503
Mercedes Benz
A0000171760

Arandela de cobre 4 muescas, asiento inyector
MERCEDES BENZ



REPUESTOS

cm1242-521A



Lucas/Delphi
9307-521A
28389851
55pp22-01

Arandela de cobre 4 muecas, asiento inyector
MERCEDES BENZ SPRINTER 415/515
OM651

REPUESTOS

cm2171-002



Kit de o'rings, externo

MERCEDES BENZ PDE 100-110 ATEGO

cm2171-003



Kit de o'rings, externo

MERCEDES BENZ PDE 100-110 ACTROS

cm2171-016



Bosch
2430210082
Mercedes Benz
A5419970645

Kit de 12 o'rings para canula entre tubo inyector e inyector

MERCEDES BENZ OM904/OM906/OM457

cm2171-026



Kit de reparación

MERCEDES BENZ ATEGO / PDE 110

Bosch
F00HN37070
Mercedes Benz
0120740101

cm2171-027



Kit de reparación

MERCEDES BENZ
PLD/ATEGO/AXOR OM904

Bosch
F00HN37069

cm2171-028



Kit de oring's y arandelas planas para 6 inyectores

MERCEDES BENZ OM906/OM926

cm2171-029



Kit de oring's y arandelas bujes para 6 inyectores

MERCEDES BENZ OM906/OM926

cm2171-030



Kit de oring's y arandelas planas para 4 inyectores

MERCEDES BENZ OM904/OM924

cm2171-031



Kit de oring's y arandelas bujes para 4 inyectores

MERCEDES BENZ OM904/OM924

REPUESTOS

cm3120-005



Monobomba UPS/PLD

MERCEDES BENZ AXOR 1835/2035 457 OM457
ACTROS 1831/1832/2035 OM451

Bosch
0414799005
0986445002
0986445102
Mercedes Benz
A0280745902

cm3199-002



Cánula Inyector (PLD)

MERCEDES BENZ OM904/906/924/926

Bosch
2433370467
Mercedes Benz
A5410170324
A9060170521
A9060170524
A9060170324

REPUESTOS**cm3122-416**Inyectores
0432193480 A0060171521
0432193481 A0060171421**Bosch**
0433175416
Mercedes Benz
A0060171421

Tobera DMB DSLA156P1411

**MERCEDES BENZ 915/1117L/1317L/1517L
OM904/906****cm3122-483**Inyectores
0432193445
A0000789223
Bosch
0433175483
Mercedes Benz
A0000789223

Tobera DMB DSLA150P1728

**MERCEDES BENZ ACCELO 2006 OM904
ATEGO 2000-2006 OM906LA****cm3122-484**Inyectores
0432193442
A0000789323
Bosch
A0000789323
Mercedes Benz
0433175484

Tobera DMB DSLA150P1729

**MERCEDES BENZ ATEGO/OH1518 TRUCK
OM904/906 4.3****cm3122-485**Inyectores
0432193436
0432193437**Bosch**
0433175485
Mercedes Benz
A0000789423

Tobera DMB DSLA146P1730

MERCEDES BENZ OM924/926**cm3122-489**Inyectores
0432291657
0432291658
Bosch
0433175489
Mercedes Benz
A0000789623

Tobera DMB DSLA160P1786

MERCEDES BENZ OM924/926

REPUESTOS

dmT-APL759-A

**APL759
TB0299**

Referencias
Garret
704090-0001
Maxion Rover
79035
Lubricación:
MV 1773



dmC-APL759-A

Garret
443854-0176



MERCEDES BENZ SPRINTER 310 MAXION 2.5

dmT-GT18-A

GT1852V

Referencias
Mercedes Benz Garret
A6110960899 726698-0003
A6110961699 778794-0001
A6110961599 709836-0001



dmC-GT18-A

Garret
703890-0076
703890-0350



**SOLO PARA
TURBO
778794-0001**

**MERCEDES BENZ OM 611 2.2 LA
SPRINTER CDI 211 / 311 / 411 / 213 / 313 / 413**

GT2052S

Referencias
Garret
451298-0010
CCR.708257-0001
CCR.708258-0001
Maxion Rover
CCR.79054



dmC-GT2052S-B



**MERCEDES BENZ SPRINTER 312D
MAXION 2.5 E2**

GT20

Referencias
729546-00025
794121-0002
A6280960699



MERCEDES BENZ SPRINTER

dmT-GT22V-A

GT22VK

Referencias
736088-50035
A6470900280



**MERCEDES BENZ OM647 2.7L / 5 CIL
ELECTRONICO**

GT2256VK

Referencias
A0080962899



MERCEDES BENZ OM457

R2S

Referencias
Borgwarner
10009700007
Mercedes Benz
10009700019
A6510900080
A6510902380



dmC-K04-F



dmC-KP39-E Borgwarner
54357100524



MERCEDES BENZ 220/250 OM651DE22LA

R2S

Referencias
Borgwarner Mercedes Benz
54357100524 A6510905480
10009700037 A6510906080
10009700074 A6510906380



dmC-K04-E Borgwarner
54357100525



**PARA TURBO
10009700036**

dmC-KP39-E Borgwarner
54357100524



**PARA TURBO
10009700036**

**MERCEDES BENZ SPRINTER CDI 415/515
MOTOR OM651DE22LA**

REPUESTOS

dmT-K16-A
K16
Referencias

 Mercedes benz
 9040967799
 9040969999
 KKK
 53169707122
 53169707156
 53169887122
 53169887156

dmC-K16-A
Borgwarner
 53167100527

**MERCEDES BENZ OM904 LA Euro II
 1215C / 915 / LO914 / LO915E / ATEGO 1418 / 1518**
dmT-K16-B
K16
Referencias
Borgwarner
 53169707198
 53169887198
 53169707021
 53169887021
 53169707025
 53169887025
 53169887107
 53169707107
 53169707119
 53169887119
 53169707138
 53169887138
 9040963599
 9040969099
 9000961099

MERCEDES BENZ OM904LA-EPA
dmT-K24-A
K24
Referencias

 Mercedes Benz
 9240960399
 9240960199
 9240960299
 9240960499
Borgwarner
 53249707100A
 53249887100A
 53249707119
 53249887119
 53249707102
 53249887102

**MERCEDES BENZ 1622 / 1722
 OM924LA**
K24-2671
Referencias

 A9240962199
 53249707118

dmC-K24-B
Borgwarner
 53249707118 CCR

MERCEDES BENZ OM924LA EURO 3
dmT-K24-C
B1G
Referencias
Mercedes Benz Borgwarner
 A9240963899 11559700029
 A9240963399 11559880029
 11559700005
 11559880005

dmC-K24-C
Borgwarner
 11559700029 CCR

**MERCEDES BENZ ATEGO 1719 / ACCELO 815C
 OM924LA EURO 5**
dmT-K24-D
K24
Referencias
Borgwarner
 53249707114
Mercedes Benz
 A9240961799

MERCEDES BENZ OM924LA EURO 3
dmT-K27-A
K27
Referencias
Borgwarner
 53279707120
 53279887120
Mercedes Benz
 9060964999

 53279887127
 53279707127
 53279707178
 53279887180
 9060965199
 9060968399
 9060968899

**MERCEDES BENZ BUS OML
 OM906LA-EPA EURO 3**
dmT-TO4E66-A
**TO4E66
 K27 / S2EL169**
Referencias
Mercedes Benz
 3660960899
 3660960299
 3660961399
Garret
 466646-0022
Borgwarner
 169107
 KKK
 53279706441
 53279886441

Retorno
 MV 1784/85
 MV 1792/93
 MV 1777
 MV 2225

Lubricación
 MV 1717A/B/C/D/E
 MV1720/21

dmC-TO4E66-A
Garret
 408105-0426

**OM366A/LA EURO 1
 1420 / 1620 - TURBO SIN VÁLVULA WASTEGATE**

REPUESTOS

dmT-S2AS-A

**S2AS058
TA31**

Referencias
Borgwarner
197336
Garret
466192-0013
Mercedes Benz
3640962199
3740960199
3740961799
3740961899



**MERCEDES BENZ OM364A (122CV)
710/712/912/LO812**

TA5127

Referencias
466154-5015



MERCEDES BENZ OM477

dmT-TBP4-A

TBP418-1

Referencias
Garret
452085-0008



MERCEDES BENZ OM366 LA EURO 2

dmT-TO4B27-A TO4B27

Referencias

Retorno	Mercedes Benz	KKK
MV 1706	3520962599	52239702872
MV 1706R1	3520992999	52239882872
Lubricación	3520965999	52239706000
MV 1705A	3520965999	52239886000
MV 1705B	3520965699	Borgwarner
MV 1731	Garret	312329
MV 1731R1	409300-0026	185264



dmC-TO4B27-A

Garret
408105-0127



**MERCEDES BENZ 1517/1518
OM352A**

dmT-RHF4V-A

**VV14
RHF4**

Referencias
VF40A132
6460960199



MERCEDES BENZ VITO / VIANO 2.2L

GT18

Referencias
708936-0004
726698-0003



dmC-GT18-A2

Garret
703890-0044



**MERCEDES BENZ SPRINTER CDI 211 / 311 / 411
SPRINTER CDI 213 / 313 / 413 OM611 2.2 LA**

dmT-TA45-C

TA4521

Referencias
Garret
466618-0006
466154-0013
466336-0015
466618-0019
Borgwarner
53299887001
Holset
3580214



1630 / 1633 / 1925 / 2325 OM449A

dmT-K24-B

K24

Referencias

Mercedes Benz	Garret
A9240962199	817280-0001
A9240961799	Borgwarner
A9240962099	53249707118
A9240961599	53249707113
A9240960499	53249707114
A9240960699	53249707119
A9240960999	53249707120
	53249707122



ATEGO 1723 / 2423 OM924LA EURO 3

REPUESTOS

bcA0005535901

Mercedes Benz
A0005535901
A0015530001
A3755530001
A0015535901

Bomba levanta cabina DMB

**MERCEDES BENZ ACTROS/AXOR
AXOR 2/ATEGO/ATEGO 3/ECONIC****bcA0015533801**

Mercedes Benz
A0015533801

Bomba levanta cabina DMB

MERCEDES BENZ ACTROS MP2/MP3**bcA0015534101**

Mercedes Benz
A0015534101

Bomba levanta cabina DMB

MERCEDES BENZ ACTROS**bcA6935537001**

Mercedes Benz
A6935537001

Bomba levanta cabina DMB

**MERCEDES BENZ AXOR 1938S/1944S
2035/2040/2044/2540/2544/264****bcA9585530201**

Mercedes Benz
A9585530201
A9585530501

Bomba levanta cabina DMB

**MERCEDES BENZ AXOR 1933/1933LS/1933 S
2533/2826/2831/3131/3131K - ATEGO 1725****bcA9585530301**

Mercedes Benz
9585530101
9585530301
9585530401

Bomba levanta cabina DMB

**MERCEDES BENZ AXOR 1933/1933LS/1933 S
2533/2826/2831/3131/3131K - ATEGO 1725****bcW2R2899501A**

Mercedes Benz
A0005532301
A0005532701
A0005533701
A0005533901
A0005534001

Bomba levanta cabina DMB

MERCEDES BENZ ATEGO

REPUESTOS

fcA9405530282

Mercedes Benz
A9405530282

Flexible levanta cabina DMB

MERCEDES BENZ ACTROS/ATEGO/AXOR 1933**fcA9405530582**

Mercedes Benz
A9405530582
A9405532782

Flexible levanta cabina DMB

MERCEDES BENZ AXOR**fcA9585530482**

Mercedes Benz
A9585530482
A9585530582

Flexible levanta cabina DMB

MERCEDES BENZ AXOR OM457**fcA9585530682**

Mercedes Benz
A9585530682

Flexible levanta cabina DMB

MERCEDES BENZ AXOR



BOSCH

0 432 193 480 - PORTAINYECTOR CON TOBERA - DHK

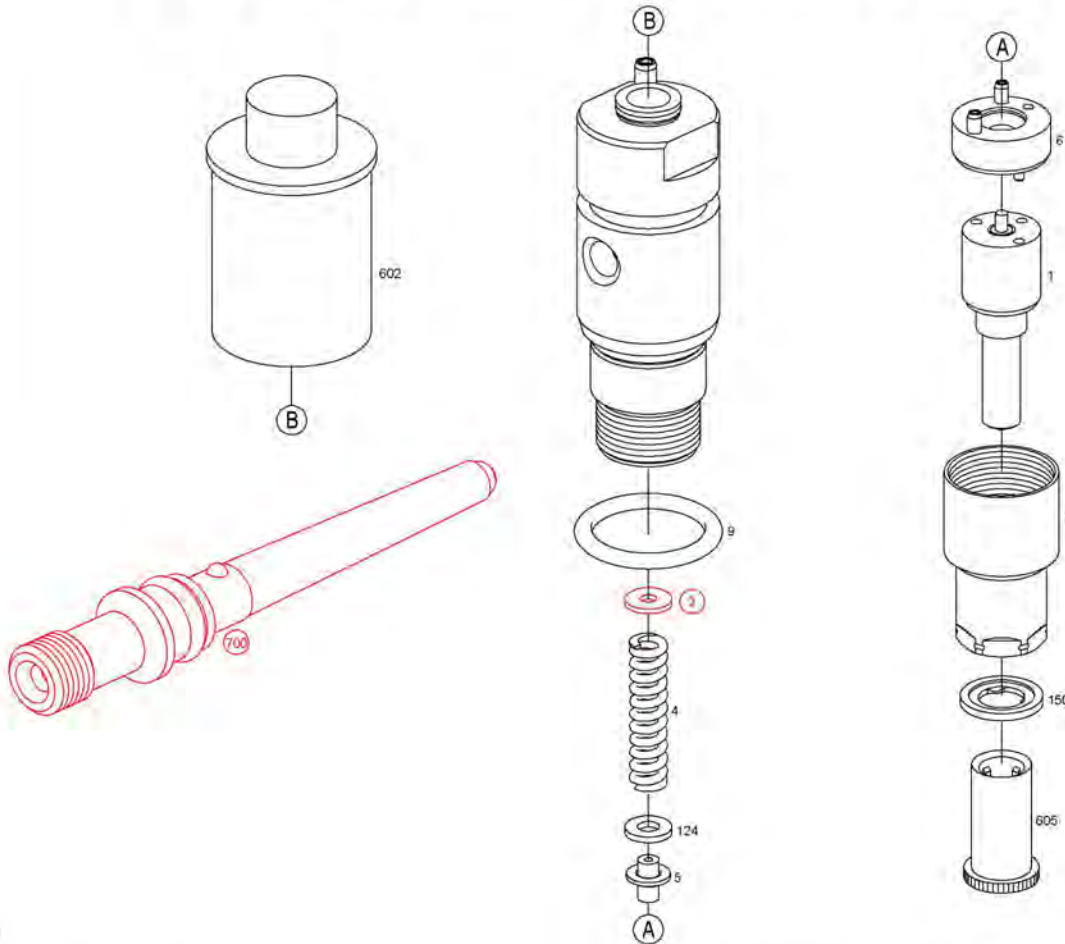

ITEM	CODIGO CMD	CODIGO	DENOMINACION
1		0 433 175 416	INYECTOR DE ORIFICIOS
3			SURTIDO DE PIEZAS ARANDELA DE AJUSTE
3			SURTIDO DE PIEZAS ARANDELA DE AJUSTE
4	RP 184/7	2 434 614 055	MUELLE DE COMPRESION
5		F 00Z B20 002	TOPE DE PRESION
6	PLQ 164/16	2 430 136 221	DISCO INTERMEDIO
7	PT 170/66	2 433 349 503	TUERCA FIJACION INYECTOR
9	AG 122/603	2 430 210 081	ANILLO TOROIDAL
124		F 00Z M20 000	ARANDELA
150	AC 112/50	2 430 105 049	ANILLO DE JUNTA
602		6 000 900 266	CAPERUZA PROTECTORA
605	CP 134/18	6 000 900 262	CAPERUZA PROTECTORA
700	CM 1399-002	2 433 370 448	RACOR DE TUBO DE PRESION



BOSCH

0 414 799 003 - INYECTOR - BOMBA - PLD1C100/440/24S140

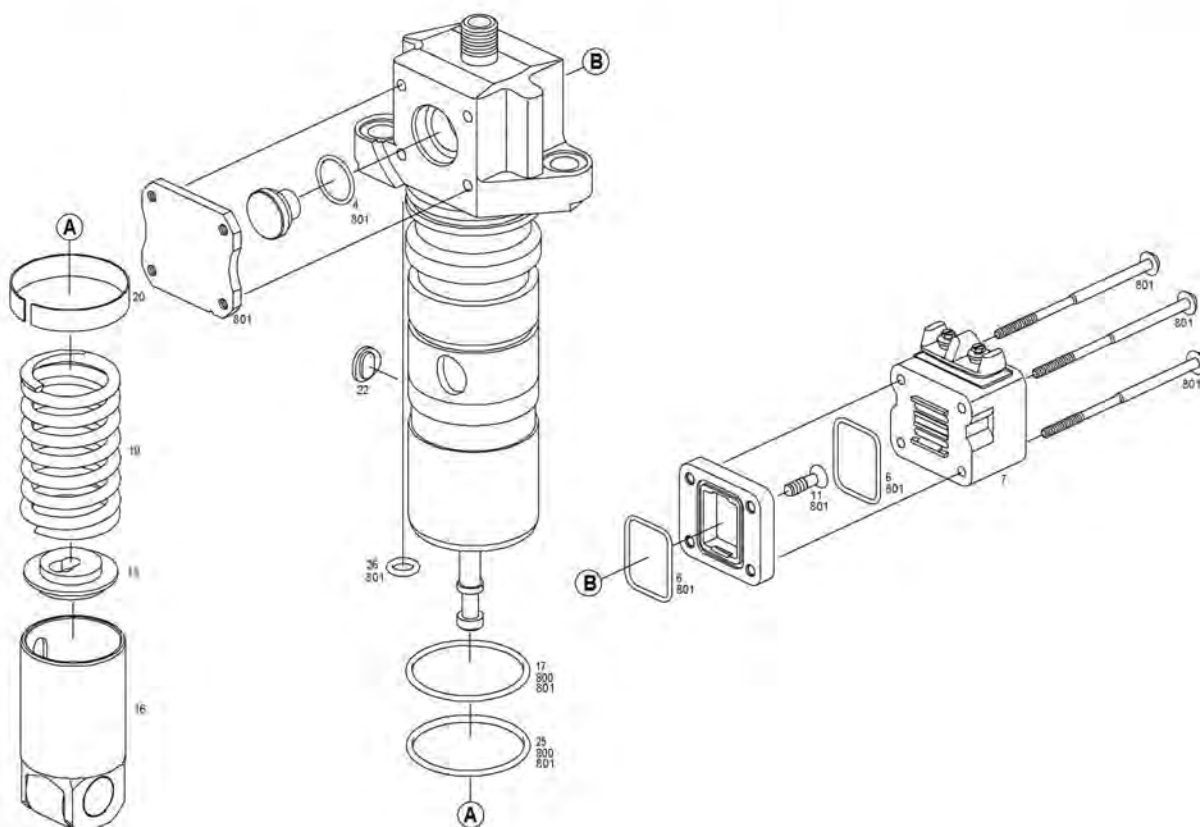

ITEM	CODIGO CMD	CODIGO	DENOMINACION
0		F 00H N35 723	ANILLO TOROIDAL
6		F 00H N37 008	ANILLO DE JUNTA
7		F 00H N35 997	IMAN
11		F 00H N35 725	TORNILLO TORX AVELLANADO
15		F 00H N37 779	PLATILLO DE MUELLE
16		F 00H N36 628	IMPULSOR DE RODILLO
17	AG 122/605	F 00H N36 644	ANILLO TOROIDAL
19		F 00H N35 977	MUELLE DE COMPRESION
20		F 00H N36 474	ANILLO DE SEGURIDAD
22		F 00H N36 632	PIEZA GUIA
25	AG 122/606	F 00H N37 622	ANILLO TOROIDAL
		F 00H N35 985	ANILLO TOROIDAL
800	JR 155/312AG	F 00H N37 454	JUEGO DE PIEZAS ANILLO TOROIDAL
801	CM 2171-026	F 00H N37 070	JUEGO DE PIEZAS TAPA DE VALVULA



Mercedes-Benz
LÍNEA PESADA

Catálogo de tuberías



- Tuberías flexibles y rígidas.
- Lubricación de turbo y descarga.
- Lubricación de aceite.
- Tuberías de inyección convencional y Common Rail.
- Tuberías de inyección para bancos de prueba convencional y Common Rail.
- Tuberías flexibles y rígidas para compresor.
- Tuberías de freno y dirección hidráulica.
- Tuberías de agua.

ATENCIÓN

Sobre presentación de muestra fabricamos todo tipo de tuberías para el automotor.



Motor Universal	Mercedes Benz Todos
Motor OM314 - OM340	Mercedes Benz L608
Motor OM312 - OM321	Mercedes Benz 312 - 315 - 1112
Motor OM352 - OM352A	Mercedes Benz 1114-1116-1517-1518
Motor OM355 - OM355A	Mercedes Benz 1521
Motor OM355/6	Mercedes Benz 1526
Motor OM364 - OM364A	Mercedes Benz 710 - 712 - 813 - 814 910 - 912 - 914
Motor OM366 - OM366LA OM366LK	Mercedes Benz 1215 - 1218 - 1315 1316 - 1320 - 1418 1420 - 1421 - 1620 1621 - 1718 - 1721
Motor OM447	Mercedes Benz 1938 - 1941
Motor OM449	Mercedes Benz 1633 - 1635
Motor OM457LA Euro III con mando electrónico	Mercedes Benz 2035S / 36- 2040S / 36 3340 K Volcador 6x4 1634 / 51 - 1634S / 45
Motor OM616	Mercedes Benz 180
Motor Maxion Rover	Mercedes Benz Sprinter 310 - 312 410 - 412

Motor OM457LA Euro III con mando electrónico	Mercedes Benz 2035S / 36- 2040S / 36 3340 K Volcador 6x4 1634 / 51 – 1634S / 45
Motor MB OM 904LA Euro III con mando electrónico	1418 / 36 – 1720 / 36 1720/48 – 915C / 37
Motor MB OM 906 LA Euro III con mando electrónico	1725 - 42 / 1725S – 36 2425/ 48 6x2 - 1725 - 42 4x4 1624 / 45 - 1624 / 51

BUSES

MB OM 457 LA O 500 UA	MB OM 904 LA LO 915 42 OH 1618 L-SB OH 1718 L-SB OF 1418 / 52 OH 1518 / 52
MB OM 906 LA O 500 / U 59 O 500 M / 30	



Los códigos terminados en "/9,5" indican que el \varnothing es de 9,5x14.
En el caso del resto, el \varnothing es de 8x12.

MV 1001	Uniones cruzadas	200 mm.	MV 1008	Uniones paralelas	350 mm.
MV 1003	Uniones cruzadas	250 mm.	MV 1010	Uniones paralelas	400 mm.
MV 1005	Uniones cruzadas	300 mm.	MV 1010/9,5	Uniones paralelas	400 mm.
MV 1007	Uniones cruzadas	350 mm.	MV 1012	Uniones paralelas	450 mm.
MV 1007/9,5	Uniones cruzadas	350 mm.	MV 1014	Uniones paralelas	500 mm.
MV 1009	Uniones cruzadas	400 mm.	MV 1014/9,5	Uniones paralelas	500 mm.
MV 1011	Uniones cruzadas	450 mm.	MV 1016	Uniones paralelas	550 mm.
MV 1011/9,5	Uniones cruzadas	450 mm.	MV 1018	Uniones paralelas	600 mm.
MV 1013	Uniones cruzadas	500 mm.	MV 1018/9,5	Uniones paralelas	600 mm.
MV 1015	Uniones cruzadas	550 mm.	MV 1020	Uniones paralelas	650 mm.
MV 1015/9,5	Uniones cruzadas	550 mm.	MV 1020/9,5	Uniones paralelas	650 mm.
MV 1017	Uniones cruzadas	600 mm.	MV 1022	Uniones paralelas	700 mm.
MV 1017/9,5	Uniones cruzadas	600 mm.	MV 1022/9,5	Uniones paralelas	700 mm.
MV 1019	Uniones cruzadas	650 mm.	MV 1024	Uniones paralelas	750 mm.
MV 1021	Uniones cruzadas	700 mm.	MV 1024/9,5	Uniones paralelas	750 mm.
MV 1021/9,5	Uniones cruzadas	700 mm.	MV 1026	Uniones paralelas	800 mm.
MV 1023	Uniones cruzadas	750 mm.	MV 1026/9,5	Uniones paralelas	800 mm.
MV 1025	Uniones cruzadas	800 mm.	MV 1028	Uniones paralelas	850 mm.
MV 1027	Uniones cruzadas	850 mm.	MV 1028/9,5	Uniones paralelas	850 mm.
MV 1029	Uniones cruzadas	900 mm.	MV 1030	Uniones paralelas	900 mm.
MV 1029/9,5	Uniones cruzadas	900 mm.	MV 1030/9,5	Uniones paralelas	900 mm.
MV 1031	Uniones cruzadas	950 mm.	MV 1032	Uniones paralelas	950 mm.
MV 1033	Uniones cruzadas	1000 mm.	MV 1034	Uniones paralelas	1000 mm.
MV 1035	Uniones cruzadas	1050 mm.	MV 1034/9,5	Uniones paralelas	1000 mm.
MV 1037	Uniones cruzadas	1100 mm.	MV 1036	Uniones paralelas	1050 mm.
MV 1039	Uniones cruzadas	1150 mm.	MV 1038	Uniones paralelas	1100 mm.
MV 1041	Uniones cruzadas	1200 mm.	MV 1038/9,5	Uniones paralelas	1100 mm.
MV 1043	Uniones cruzadas	1250 mm.	MV 1040	Uniones paralelas	1150 mm.
MV 1045	Uniones cruzadas	1300 mm.	MV 1042	Uniones paralelas	1200 mm.
MV 1047	Uniones cruzadas	1350 mm.	MV 1042/9,5	Uniones paralelas	1200 mm.
MV 1049	Uniones cruzadas	1400 mm.	MV 1044	Uniones paralelas	1250 mm.
MV 1051	Uniones cruzadas	1450 mm.	MV 1046	Uniones paralelas	1300 mm.
MV 1053	Uniones cruzadas	1500 mm.	MV 1048	Uniones paralelas	1350 mm.
			MV 1048/9,5	Uniones paralelas	1350 mm.
			MV 1050	Uniones paralelas	1400 mm.
			MV 1050/9,5	Uniones paralelas	1400 mm.
MV 1002	Uniones paralelas	200 mm.	MV 1052	Uniones paralelas	1450 mm.
MV 1004	Uniones paralelas	250 mm.	MV 1054	Uniones paralelas	1500 mm.
MV 1006	Uniones paralelas	300 mm.	MV 1054/9,5	Uniones paralelas	1500 mm.
MV 1006/9,5	Uniones paralelas	300 mm.	MV 1059	Uniones paralelas	1700 mm.



MV 1060	200 mm. - Tuercas 1/2x20 - Manguera remallado 8x12
MV 1061	250 mm. - Tuercas 1/2x20 - Manguera remallado 8x12
MV 1062	300 mm. - Tuercas 1/2x20 - Manguera remallado 8x12
MV 1063	350 mm. - Tuercas 1/2x20 - Manguera remallado 8x12
MV 1064	400 mm. - Tuercas 1/2x20 - Manguera remallado 8x12
MV 1065	450 mm. - Tuercas 1/2x20 - Manguera remallado 8x12
MV 1066	500 mm. - Tuercas 1/2x20 - Manguera remallado 8x12
MV 1067	550 mm. - Tuercas 1/2x20 - Manguera remallado 8x12
MV 1068	600 mm. - Tuercas 1/2x20 - Manguera remallado 8x12
MV 1069	650 mm. - Tuercas 1/2x20 - Manguera remallado 8x12
MV 1070	700 mm. - Tuercas 1/2x20 - Manguera remallado 8x12
MV 1071	750 mm. - Tuercas 1/2x20 - Manguera remallado 8x12
MV 1072	800 mm. - Tuercas 1/2x20 - Manguera remallado 8x12
MV 1073	850 mm. - Tuercas 1/2x20 - Manguera remallado 8x12
MV 1074	900 mm. - Tuercas 1/2x20 - Manguera remallado 8x12
MV 1075	950 mm. - Tuercas 1/2x20 - Manguera remallado 8x12
MV 1076	1000 mm. - Tuercas 1/2x20 - Manguera remallado 8x12
MV 1077	1050 mm. - Tuercas 1/2x20 - Manguera remallado 8x12
MV 1078	1100 mm. - Tuercas 1/2x20 - Manguera remallado 8x12
MV 1079	1150 mm. - Tuercas 1/2x20 - Manguera remallado 8x12
MV 1080	1200 mm. - Tuercas 1/2x20 - Manguera remallado 8x12
MV 1081	1250 mm. - Tuercas 1/2x20 - Manguera remallado 8x12
MV 1082	1300 mm. - Tuercas 1/2x20 - Manguera remallado 8x12
MV 1083	1350 mm. - Tuercas 1/2x20 - Manguera remallado 8x12
MV 1084	1400 mm. - Tuercas 1/2x20 - Manguera remallado 8x12
MV 1085	1450 mm. - Tuercas 1/2x20 - Manguera remallado 8x12
MV 1086	1500 mm. - Tuercas 1/2x20 - Manguera remallado 8x12
MV 1087	1550 mm. - Tuercas 1/2x20 - Manguera remallado 8x12
MV 1088	1600 mm. - Tuercas 1/2x20 - Manguera remallado 8x12
MV 1089	1650 mm. - Tuercas 1/2x20 - Manguera remallado 8x12
MV 1090	1700 mm. - Tuercas 1/2x20 - Manguera remallado 8x12
MV 1091	1750 mm. - Tuercas 1/2x20 - Manguera remallado 8x12.

nl M 3**Mercedes Benz**

1) 314070 13 33

2) 314 070 14 33

3) 314 070 15 33

4) 314 070 16 33

Conjunto de 4 tuberías de inyección

MERCEDES BENZ 608D**MV 0221****Mercedes Benz**
007 997 9782

De retorno a tanque intermedio

MERCEDES BENZ**MV 0222****Mercedes Benz**
314 070 1332

De bomba de alimentación a filtro

MERCEDES BENZ**MV 0223****Mercedes Benz**
314 070 1432

De filtro a bomba de inyección

MERCEDES BENZ**MV 0224****Mercedes Benz**
314 070 1532

De bomba de inyección a filtro

MERCEDES BENZ

MV 0225**Mercedes Benz**
314 070 0235

Colector descarga de inyectores

MERCEDES BENZ**MV 1708****Mercedes Benz**
348 470 0024

De aspirador a tanque

MERCEDES BENZ**MV 3548**

Reforma - Cañería para compresor de 608

MERCEDES BENZ**MV 0226A****Mercedes Benz**
348 470 0024

Tubería de aceite para bomba inyectora de 608

MERCEDES BENZ**MV 0226B****Mercedes Benz**
314 070 0235

Tubería de aceite para bomba inyectora de 608

MERCEDES BENZ

REPUESTOS

MV 0933**Mercedes Benz**
3514667765

Tubería rígida, salida caja de dirección

MERCEDES BENZ UNIVERSAL - 608
OM314 / OM340 / OM352

REPUESTOS

nI M 2

Conjunto de 6 tuberías de inyección

MERCEDES BENZ 3500/312/911/1112/321

REPUESTOS

MV 0166

Tubería de entrada a bomba de alimentación

MERCEDES BENZ**MV 0167****Mercedes Benz**
312 070 1232

Tubería de bomba de alimentación a filtro

MERCEDES BENZ

MV 0168**Mercedes Benz**
312 070 1032

Tubería de filtro a bomba de inyección

MERCEDES BENZ**MV 0169****Mercedes Benz**
303 470 0115

Tubería de filtro a caño de tanque retorno

MERCEDES BENZ**MV 0170****Mercedes Benz**
312 476 0026

Flexible intermedio retorno de inyectores

MERCEDES BENZ**MV 0171****Mercedes Benz**
312 548 1038

Intermedio tanque a

MERCEDES BENZ**MV 0172****Mercedes Benz**
312 476 0026

Tubería colector descarga de inyectores

MERCEDES BENZ**MV 0176**

Tubería de bomba de alimentación a filtro

MERCEDES BENZ**MV 0177****Mercedes Benz**
312 070 0432

Tubería de filtro a bomba de inyección

MERCEDES BENZ**MV 0178**

Tubería de filtro a caño de tanque retorno

MERCEDES BENZ

MV 0180

Tubería de filtro a bomba de inyección

MERCEDES BENZ**MV 0182**

Tubería de bomba alimentación a filtro

MERCEDES BENZ**Mercedes Benz**
321 070 0132**MV 0183**

Tubería de filtro a bomba de inyección

MERCEDES BENZ**Mercedes Benz**
321 070 1032**MV 0183A**

Tubería de filtro a bomba de inyección

MERCEDES BENZ**Mercedes Benz**
321 070 1032**MV 0186**

Tubería de bomba alimentación a filtro

MERCEDES BENZ**Mercedes Benz**
321 070 1032**MV 0187**

Tubería de filtro a bomba de inyección

MERCEDES BENZ**MV 0188**

Tubería de inyección a filtro

MERCEDES BENZ**MV 0189**

Tubería de filtro primario a bomba de alimentación

MERCEDES BENZ

MV 0190

Tubería de filtro secundario a bomba de inyección

MERCEDES BENZ**MV 0203**

Tubería de filtro a bomba de inyección

MERCEDES BENZ**MV 0215**

Tubería de aspiración de combustible a tanque

MERCEDES BENZ**MV 0205**

Tubería de filtro principal a bomba

MERCEDES BENZ**MV 0220****Mercedes Benz**
0069979582

Tubería de entrada a bomba de alimentación

MERCEDES BENZ**MV 0174****Mercedes Benz**
3125401260

Tubería de block a manómetro de aceite

MERCEDES BENZ**MV 0184****Mercedes Benz**
3225420035

Tubería de manómetro de aceite

MERCEDES BENZ

REPUESTOS

MV 3151

Trasero derecho 800mm

MV 3152

Trasero izquierdo 1300mm

MV 3153

Delantero derecho 2700mm

MV 3154

Delantero izquierdo 950mm

MV 3155

Central 4800mm

MV 3156

Reforma 1050mm

MV 3157

Reforma 1850mm



Tuberías de filtro secundario a bomba de inyección

MERCEDES BENZ

REPUESTOS

MV 0161



Mercedes Benz
3215420035

Tubería flexible de manómetro de aire

MERCEDES BENZ 1112/1114
OM312 / OM 315 / OM 321 / OM 352

MV 0185



Mercedes Benz
322 542 0035

Tubería de manómetro de aire

MERCEDES BENZ

MV 0191



Tubería movimiento de puerta delantera

MERCEDES BENZ

MV 0192



Tubería movimiento de puerta trasera

MERCEDES BENZ

MV 0206



Mercedes Benz
321 072 0132

Tubería de conducción de agua y aire

MERCEDES BENZ

MV 3501/22

Flexible salida de compresor con tuerca de 22mm y nipples planos

MV 3501/26

Flexible salida de compresor con tuerca de 26mm y nipples planos

MV 3501/22A

de 200mm

MV 3501/26A

de 200mm

MV 3501/22B

de 300mm

MV 3501/26B

de 300mm

MV 3501/22C

de 400mm

MV 3501/26C

de 400mm

MV 3501/22D

de 500mm

MV 3501/26D

de 500mm

MV 3501/22E

de 600mm

MV 3501/26E

de 600mm

MV 3501/22F

de 700mm

MV 3501/26F

de 700mm

MV 3501/22G

de 800mm

MV 3501/26G

de 800mm

MV 3501/22H

de 900mm

MV 3501/26H

de 900mm

MV 3501/22I

de 1000mm

MV 3501/26I

de 1000mm

MV 3501/22J

de 1100mm

MV 3501/26J

de 1100mm

MV 3501/22K

de 1200mm

MV 3501/26K

de 1200mm

MV 3501/22L

de 1500mm

MV 3501/26L

de 1500mm

MV 3501/22M

de 1800mm

MV 3501/26M

de 1800mm

MV 3501/22N

de 2000mm

MV 3501/26N

de 2000mm

MV 3501/22-NM

Flexible salida de compresor con tuerca de 22mm y nipples conicos

MV 3501/26-NM

Flexible salida de compresor con tuerca de 26mm y nipples conicos

MV 3501/22A-NM

de 200mm

MV 3501/26A-NM

de 200mm

MV 3501/22B-NM

de 300mm

MV 3501/26B-NM

de 300mm

MV 3501/22C-NM

de 400mm

MV 3501/26C-NM

de 400mm

MV 3501/22D-NM

de 500mm

MV 3501/26D-NM

de 500mm

MV 3501/22E-NM

de 600mm

MV 3501/26E-NM

de 600mm

MV 3501/22F-NM

de 700mm

MV 3501/26F-NM

de 700mm

MV 3501/22G-NM

de 800mm

MV 3501/26G-NM

de 800mm

MV 3501/22H-NM

de 900mm

MV 3501/26H-NM

de 900mm

MV 3501/22I-NM

de 1000mm

MV 3501/26I-NM

de 1000mm

MV 3501/22J-NM

de 1100mm

MV 3501/26J-NM

de 1100mm

MV 3501/22K-NM

de 1200mm

MV 3501/26K-NM

de 1200mm

MV 3501/22L-NM

de 1500mm

MV 3501/26L-NM

de 1500mm

MV 3501/22M-NM

de 1800mm

MV 3501/26M-NM

de 1800mm

MV 3501/22N-NM

de 2000mm

MV 3501/26N-NM

de 2000mm



MV 3502

MV 3503



Flexible salida compresor

MERCEDES BENZ

MV 3504

MV 3505

MV 3506

MV 3507

Trasero de 720mm

Delantero de 620mm

Delantero de 420mm

Válvula manual de 500 mm



Flexible de aire comprimido

MERCEDES BENZ

MV 3508

MV 3509

Válvula distribuidora de 240 mm

Válvula distribuidora de 510 mm



Flexible de aire comprimido

MERCEDES BENZ

MV 3524/22

Reforma compresor recto reforzado c/tuerca de 22mm y niples planos

MV 3524/26

Reforma compresor recto reforzado c/tuerca de 26mm y niples planos



MV 3524/22A-NM

de 1100mm

MV 3524/22B-NM

de 1500mm

MV 3524/22C-NM

de 1000mm

MV 3524/22D-NM

de 1200mm

MV 3524/22E-NM

de 1400mm

MV 3524/22F-NM

de 500mm

MV 3524/22G-NM

de 700mm

MV 3524/22H-NM

de 800mm

MV 3524/22I-NM

de 1700mm

MV 3524/22J-NM

de 2000mm

MV 3524/26A-NM

de 1100mm

MV 3524/26B-NM

de 1500mm

MV 3524/26C-NM

de 1000mm

MV 3524/26D-NM

de 1200mm

MV 3524/26E-NM

de 1400mm

MV 3524/26F-NM

de 500mm

MV 3524/26G-NM

de 700mm

MV 3524/26H-NM

de 800mm

MV 3524/26I-NM

de 1700mm

MV 3524/26J-NM

de 2000mm



MV 3524/22 Reforma compresor recto reforzado c/tuerca de 22mm y niples planos

MV 3524/26 Reforma compresor recto reforzado c/tuerca de 26mm y niples planos



MV 3524/22A-NM	de 1100mm	MV 3524/26A-NM	de 1100mm
MV 3524/22B-NM	de 1500mm	MV 3524/26B-NM	de 1500mm
MV 3524/22C-NM	de 1000mm	MV 3524/26C-NM	de 1000mm
MV 3524/22D-NM	de 1200mm	MV 3524/26D-NM	de 1200mm
MV 3524/22E-NM	de 1400mm	MV 3524/26E-NM	de 1400mm
MV 3524/22F-NM	de 500mm	MV 3524/26F-NM	de 500mm
MV 3524/22G-NM	de 700mm	MV 3524/26G-NM	de 700mm
MV 3524/22H-NM	de 800mm	MV 3524/26H-NM	de 800mm
MV 3524/22I-NM	de 1700mm	MV 3524/26I-NM	de 1700mm
MV 3524/22J-NM	de 2000mm	MV 3524/26J-NM	de 2000mm



MV 3524/22 Flexible salida de compresor reforma con tuerca de 22mm y niples planos

MV 3524/26 Flexible salida de compresor reforma con tuerca de 26mm y niples planos

MV 3524/22K	de 2000mm	MV 3524/26K	de 2000mm
MV 3524/22L	de 700mm	MV 3524/26L	de 700mm



MANGUERA R1

MV 3524/22-NM Flexible salida de compresor reforma con tuerca de 22mm y niples cónicos

MV 3524/26-NM Flexible salida de compresor reforma con tuerca de 26mm y niples cónicos

MV 3524/22K-NM	de 2000mm	MV 3524/26K-NM	de 2000mm
MV 3524/22L-NM	de 700mm	MV 3524/26L-NM	de 700mm



MANGUERA R1

REPUESTOS

MV 3525

Flexible reforma compresor curvo reforzado - Linea 312/321

MERCEDES BENZ

REPUESTOS

n1 M 4**Mercedes Benz**

- 1) 3520703233
- 2) 3520703333
- 3) 3520703433
- 4) 3520703533
- 5) 3520703633
- 6) 3520703733

Flexible reforma compresor curvo reforzado - Linea 312/321

MERCEDES BENZ

REPUESTOS

MV 0204**Mercedes Benz**
390 420 72 36

Tubería de inyector a tanque

MERCEDES BENZ**MV 0207**

Tubería salida de filtro

MERCEDES BENZ

MV 0208

Tubería de inyector a tanque conector de retorno

MERCEDES BENZ**MV 0209**

Tubería rígida entrada a bomba de alimentación

MERCEDES BENZ**MV 0210**Mercedes Benz
352 070 00 32

Tubería de bomba de alimentación a filtro

MERCEDES BENZ**MV 0211**

Tubería de salida de filtro doble

MERCEDES BENZ**MV 0212**Mercedes Benz
352 070 01 32

Tubería de bomba de alimentación a filtro

MERCEDES BENZ**MV 0213A**Mercedes Benz
352 070 02 35

Tubería colector rebase de inyectores

MERCEDES BENZ**MV 0213B**Mercedes Benz
344 070 00 35

Tubería colector rebase de inyectores

MERCEDES BENZ**MV 0215**Mercedes Benz
390 420 72 36

Tubería aspiración de combustible a tanque

MERCEDES BENZ

REPUESTOS

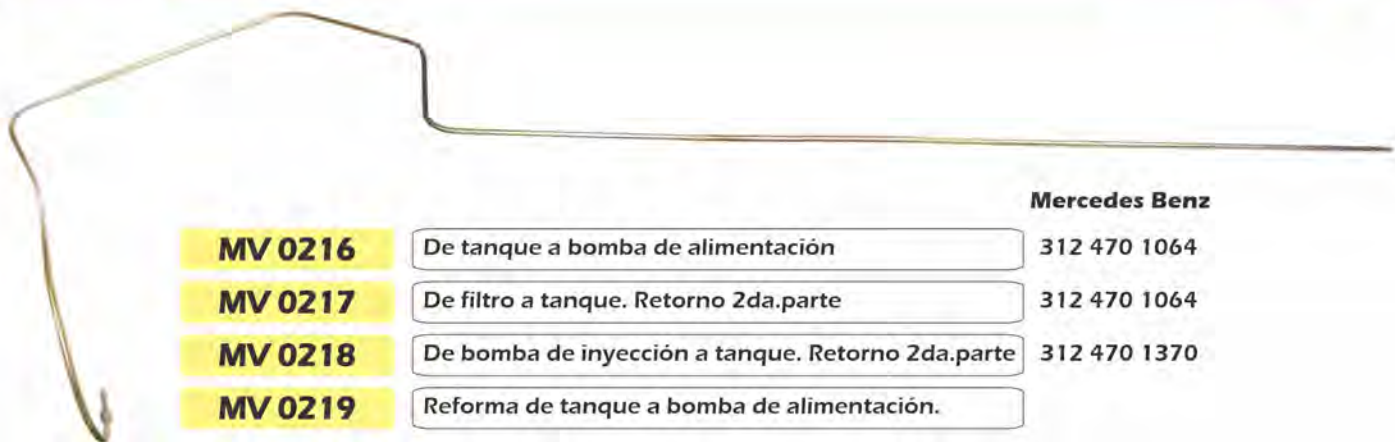

MV 0216

De tanque a bomba de alimentación

Mercedes Benz

312 470 1064

MV 0217

De filtro a tanque. Retorno 2da.parte

312 470 1064

MV 0218

De bomba de inyección a tanque. Retorno 2da.parte

312 470 1370

MV 0219

Reforma de tanque a bomba de alimentación.

MV 0219B



Reforma - Tubería de tanque a bomba de alimentación

MERCEDES BENZ

MV 0235A



Mercedes Benz
352 070 2832

Tubería de bomba de alimentación a filtro - 350mm

MERCEDES BENZ

MV 0235B

Goma



Mercedes Benz
352 070 2832

Reforma - Tubería de bomba de alimentación a filtro - 350mm

MERCEDES BENZ

MV 0235C

Goma enmallada



Mercedes Benz
352 070 2832

Reforma - Tubería de bomba de alimentación a filtro - 350mm

MERCEDES BENZ

MV 0236A

Poliamida



Mercedes Benz
352 070 2732

Tubería de filtro a bomba de inyección - 290mm

MERCEDES BENZ

MV 0236B

Goma



Mercedes Benz
352 070 2732

Reforma - Tubería de filtro a bomba de inyección - 290mm

MERCEDES BENZ

MV 0236C

Goma enmallada

**Mercedes Benz**
352 070 2732

Reforma - Tubería de filtro a bomba de inyección - 290mm

MERCEDES BENZ**MV 0237A**

Poliamida

**Mercedes Benz**
352 070 3032

Tubería de bomba de inyección a filtro retorno - 450mm

MERCEDES BENZ**MV 0237B****Mercedes Benz**
352 070 3032

Reforma - Tubería de bomba de iny. a filtro retorno - 450mm

MERCEDES BENZ**MV 0237C****Mercedes Benz**
352 070 3032

Reforma - Tubería de bomba iny. a filtro retorno - 450mm

MERCEDES BENZ**MV 0239A****Mercedes Benz**
352 070 3632

Tubería de bomba de alimentación a filtro - 600mm

MERCEDES BENZ**MV 0239B****Mercedes Benz**
352 070 3632

Reforma - Tubería de bomba de alimentación a filtro 600mm

MERCEDES BENZ**MV 0239C****Mercedes Benz**
352 070 3632

Reforma - Tubería de bomba de alimentación a filtro 600mm

MERCEDES BENZ**MV 0255A****Mercedes Benz**
352 070 3732

Tubería de filtro a bomba inyectora - 230mm

MERCEDES BENZ

MV 0255B**Mercedes Benz**
352 070 3732

Reforma - Tubería de filtro a bomba inyectora - 230mm

MERCEDES BENZ**MV 0255C****Mercedes Benz**
352 070 3732

Reforma - Tubería de filtro a bomba inyectora - 230mm

MERCEDES BENZ**MV 0256A**

Poliamida

Mercedes Benz
352 070 0532

Tubería de válvula s/ presión a distribuidor - 500mm

MERCEDES BENZ**MV 0256B**

Goma

Mercedes Benz
352 070 0532

Reforma - Tubería de válvula s/presión a distribución - 500mm

MERCEDES BENZ**MV 0256C**

Goma enmallada

Mercedes Benz
352 070 0532

Reforma - Tubería de válvula s/presión a distribución - 500mm

MERCEDES BENZ**MV 0257A**

Poliamida

Mercedes Benz
352 070 0632

Tubería de filtro doble a distribuidor 750mm

MERCEDES BENZ**MV 0257B**

Goma enmallada

Mercedes Benz
352 070 0632

Reforma - Tubería de filtro doble a distribuidor - 750mm

MERCEDES BENZ**MV 0257C**

Goma

Mercedes Benz
352 070 0632

Reforma - Tubería de filtro doble a distribuidor - 750mm

MERCEDES BENZ

MV 1704

Reforma - Tubería de filtro a bomba inyectora - 230mm

MERCEDES BENZ**MV 0175**

De block a manómetro de aceite

MERCEDES BENZ**MV 0181**

Goma enmallada

**Mercedes Benz**
352 070 3632

De caño rígido a manómetro

MERCEDES BENZ**MV 0214A**

Goma

**Mercedes Benz**
352 180 1020

Lubricación de bomba de inyección

MERCEDES BENZ**MV 0214B**

Poliamida

**Mercedes Benz**
352 180 2720

Lubricación de bomba de inyección

MERCEDES BENZ

MV 0214C

Goma enmallada



Mercedes Benz
352 180 2720

Lubricación de bomba de inyección

MERCEDES BENZ

MV 0214D



Mercedes Benz
352 180 2720

Reforma - De filtro a bomba inyectora - 270mm

MERCEDES BENZ

MV 0214E

Poliamida



Lubricación bomba inyectora - 450mm

MERCEDES BENZ

MV 0238



Mercedes Benz
352 170 1120

De lubricación de filtro combinado a bomba inyectora

MERCEDES BENZ

MV 0251A

De 300mm

MV 0251B

De 240mm

MV 0251C

De 170mm

Goma enmallada



Lubricación collar de embrague largo

MERCEDES BENZ

MV 1705A



Lubricación de turbo

MERCEDES BENZ

MV 1705B



Lubricación turbo con uniones reforzadas

MERCEDES BENZ

MV 1705C

Flexible R1



Lubricación turbo con brida

MERCEDES BENZ

MV 1705D

Manguera enmallada



Lubricación turbo con brida

MERCEDES BENZ

MV 1706



Tubería flexible retorno de aceite turbo a carter

MERCEDES BENZ OM352

MV 1706R1



Tubería retorno de aceite turbo a carter (Goma R1)

MERCEDES BENZ OM352

MV 1706FR



Tubería Rígida y flexible, REFORMA, retorno aceite Turbo TO4B27

MERCEDES BENZ OM352

MV 1731



Tubería lubricación de turbo

MERCEDES BENZ OM352

MV 1706



Brida adaptación - Lubracación de turbo OM352/1517/1518

MERCEDES BENZ OM352

MV 0635A

240mm



Tubería universal de manómetro

MERCEDES BENZ

MV 0635B

1115mm



Tubería universal de manómetro

MERCEDES BENZ

MV 0635C

800mm

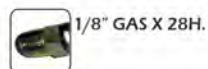

1/8" GAS X 28H.



3/8" X 28H.

Tubería universal de manómetro

MERCEDES BENZ**MV 0635D**

410mm



1/8" GAS X 28H.



3/8" X 28H.

Tubería universal de manómetro

MERCEDES BENZ**MV 0635E**

630mm

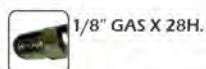

1/8" GAS X 28H.

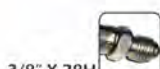

3/8" X 28H.

Tubería universal de manómetro

MERCEDES BENZ**MV 0635F**

340mm

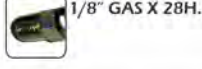

1/8" GAS X 28H.

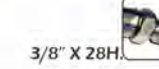

3/8" X 28H.

Tubería universal de manómetro

MERCEDES BENZ**MV 0635F**

340mm



1/8" GAS X 28H.

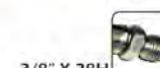

3/8" X 28H.

Tubería universal de manómetro

MERCEDES BENZ**MV 0635G**

200mm

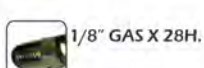

1/8" GAS X 28H.



3/8" X 28H.

Tubería universal de manómetro

MERCEDES BENZ

MV 5022**Mercedes Benz**
364 466 3465

Caño curvo rígido de alimentación

MERCEDES BENZ**MV 5023**

Goma

Mercedes Benz
360 997 0982

Flexible de unión largo

MERCEDES BENZ**MV 5024****Mercedes Benz**
345 466 0405

Caño rígido de alimentación

MERCEDES BENZ**MV 5025****Mercedes Benz**
352 466 7265

Caño curvo rígido fino salida de bomba

MERCEDES BENZ**MV 5026A**

300mm

MV 5026B

245mm

**Mercedes Benz**
345 997 1182

Caño flexible de presión

MERCEDES BENZ**MV 5027****Mercedes Benz**
351 466 7265

Caño rígido fino de presión

MERCEDES BENZ**MV 5028**

100mm

**Mercedes Benz**
352 466 1665

Flexible de unión largo

MERCEDES BENZ**MV 5029**

200mm



Reforma MV 5028 caja a recipiente - Tuerca flexible

MERCEDES BENZ

MV 5030

1600mm



Flexible c/codo largo Reforma MV 5022/5023/5024

MERCEDES BENZ**MV 5031**

Flexible de presión - Reforma MV 5025/5026/5027

MERCEDES BENZ**MV 5032A**

Manguera de retorno dirección hidráulica

MERCEDES BENZ**MV 5032B**

Manguera de retorno dirección hidráulica

MERCEDES BENZ**MV 1711**

Rígida de accionamiento de embrague OF

MERCEDES BENZ

REPUESTOS

MV 3151	Trasero Derecho - 800mm
MV 3152	Trasero Izquierdo - 1300mm
MV 3153	Delantero Derecho - 2700mm
MV 3154	Delantero Izquierdo - 950mm
MV 3155	Central - 4500mm
MV 3156	Reforma - 1050mm
MV 3157	Reforma - 1850mm

Caño rígido para freno hidráulico

MERCEDES BENZ

MV 3501/22	Flexible salida de compresor con tuerca de 22mm	
MV 3501/26	Flexible salida de compresor con tuerca de 26mm	
MV 3501/22A	de 200mm	MV 3501/26A de 200mm
MV 3501/22B	de 300mm	MV 3501/26B de 300mm
MV 3501/22C	de 400mm	MV 3501/26C de 400mm
MV 3501/22D	de 500mm	MV 3501/26D de 500mm
MV 3501/22E	de 600mm	MV 3501/26E de 600mm
MV 3501/22F	de 700mm	MV 3501/26F de 700mm
MV 3501/22G	de 800mm	MV 3501/26G de 800mm
MV 3501/22H	de 900mm	MV 3501/26H de 900mm
MV 3501/22I	de 1000mm	MV 3501/26I de 1000mm
MV 3501/22J	de 1100mm	MV 3501/26J de 1100mm
MV 3501/22K	de 1200mm	MV 3501/26K de 1200mm
MV 3501/22L	de 1500mm	MV 3501/26L de 1500mm
MV 3501/22M	de 1800mm	MV 3501/26M de 1800mm
MV 3501/22N	de 2000mm	MV 3501/26N de 2000mm



Caño rígido para freno hidráulico

MERCEDES BENZ

MV 3501/26BR1	300mm
MV3501/26CR1	400mm

MERCEDES BENZ

MV 3504	Trasero de 720mm
MV 3505	Delantero de 620mm
MV 3506	Delantero de 420mm
MV 3507	Válvula manual de 500mm

MERCEDES BENZ

REPUESTOS

MV 3518

Equipo Service corto delantero de 430mm

MV 3519

Equipo Service largo trasero de 470mm



Flexible de unión largo

MERCEDES BENZ

MV 3524/22

Reforma compresor recto reforzado c/tuerca de 22mm

MV 3524/26

Reforma compresor recto reforzado c/tuerca de 26mm

MV 3524/22A	de 1100mm	MV 3524/26A	de 1100mm
MV 3524/22B	de 1500mm	MV 3524/26B	de 1500mm
MV 3524/22C	de 1000mm	MV 3524/26C	de 1000mm
MV 3524/22D	de 1200mm	MV 3524/26D	de 1200mm
MV 3524/22E	de 1400mm	MV 3524/26E	de 1400mm
MV 3524/22F	de 500mm	MV 3524/26F	de 500mm
MV 3524/22G	de 700mm	MV 3524/26G	de 700mm
MV 3524/22H	de 800mm	MV 3524/26H	de 800mm
MV 3524/22I	de 1700mm	MV 3524/26I	de 1700mm
MV 3524/22J	de 2000mm	MV 3524/26J	de 2000mm



REPUESTOS

MV 0206



Cañería de calefacción

MERCEDES BENZ

MV 1715



Para cilindro neumático alta y baja eje HI5

MERCEDES BENZ

MV 1795



Mercedes Benz
352 134 0356

Niple de conexión a codo de admisión

MERCEDES BENZ

MV 3543C

Largo 800mm



Flexible freno neumático equipo VOLTEO
MERCEDES BENZ 1124/1517/1518
MOTOR 352/352A

MV 3525

Goma enmallada



Reforma compresor curvo reforzado
MERCEDES BENZ

MV 3535

Flexible equipo FRENARSA
MERCEDES BENZ

MV 3541A

Goma enmallada



Flexible equipo VOLTEO con goma enmallada
MERCEDES BENZ

MV 3541B

Flexible equipo VOLTEO con goma con trenza interna
MERCEDES BENZ

MV 3541C



Flexible equipo VOLTEO con goma R5

MERCEDES BENZ

MV 3541/22 Tubería salida de compresor / con goma enmallada

- MV 3541/22D** Reforma largo 500mm
- MV 3541/22E** Reforma largo 600mm
- MV 3541/22F** Reforma largo 700mm
- MV 3541/22G** Reforma largo 800mm
- MV 3541/22H** Reforma largo 900mm
- MV 3541/22I** Reforma largo 1000mm
- MV 3541/22J** Reforma largo 1200mm
- MV 3541/22K** Reforma largo 1500mm
- MV 3541/22L** Reforma largo 1800mm
- MV 3541/22M** Reforma largo 2000mm



Flexible equipo VOLTEO con goma R5

MERCEDES BENZ

MV 3542



Freno neumático equipo VOLTEO

MERCEDES BENZ

MV 3543 Largo: 500mm

MV 3543A Largo: 600mm

MV 3543B Largo: 700mm



Freno neumático equipo VOLTEO

MERCEDES BENZ

MV 3544A Largo: 0,85m

MV 3544B Largo: 1,70m



Freno neumático equipo VOLTEO

MERCEDES BENZ

MV 3551



Salida compresor aire comprimido - Reforma

MERCEDES BENZ

MV 3552



Rígido compresor - Aire comprimido

MERCEDES BENZ

MV 3555

De 1000mm

MV 3555B

De 600mm



Reforma salida de compresor

MERCEDES BENZ

MV 3556



Reforma salida de compresor

MERCEDES BENZ

MV 3566



Reforma rulo de compresor corto

MERCEDES BENZ

nl M 11



Mercedes Benz

- 1) 3450707333
- 2) 3450707433
- 3) 3450707533
- 4) 3450707633
- 5) 3450707733

Conjunto de 5 tuberías de inyección

MERCEDES BENZ 1521

REPUESTOS

nl M 10**Mercedes Benz**
346 070 1033

Cañería inyección - Interior

MERCEDES BENZ

REPUESTOS

MV 1771**Mercedes Benz**
346 070 7635

Rígido - Retorno de inyectores

MERCEDES BENZ

REPUESTOS

MV 1702**Mercedes Benz**
355 187 0075

Retorno aceite compresor

MERCEDES BENZ**MV 1703****Mercedes Benz**
345 203 7482

Refrigeración de aceite

MERCEDES BENZ

REPUESTOS

MV 1707**Mercedes Benz**
355 187 0001

Cañería rígida y flexible

MERCEDES BENZ**MV 2214****Mercedes Benz**
355 187 0282**MERCEDES BENZ 1521**
Motor OM355/5 355/5A

Flexible lubricación bomba inyectora y compresor

MERCEDES BENZ

REPUESTOS

MV 1701

De refrigeración a compresor

MERCEDES BENZ

REPUESTOS

MV 3569**Mercedes Benz**
390 420 8349

De refrigeración a compresor

MERCEDES BENZ

REPUESTOS

nl M 18**Mercedes Benz**

- 1) 3450707933
- 2) 3450708033
- 3) 3450708133
- 4) 3450708233
- 5) 3450708333
- 6) 3450708433

Conjunto de 6 tuberías de inyección

MERCEDES BENZ 1528

REPUESTOS

nl M 10**Mercedes Benz**

346 070 1033

Cañería inyección - interior

MERCEDES BENZ

REPUESTOS

MV 1771**Mercedes Benz**

346 070 7635

Rigido - retorno de inyectores

MERCEDES BENZ

REPUESTOS

MV 2214



Mercedes Benz
355 187 0282

Flexible lubricación bomba inyectora y compresor

MERCEDES BENZ

REPUESTOS

nl M 15



Mercedes Benz
1) 364 070 15 33
2) 364 070 16 33
3) 364 070 17 33
4) 364 070 18 33

Conjunto de 4 tuberías de inyección

MERCEDES BENZ 709/710/712/812/814/912/914

nl M 33

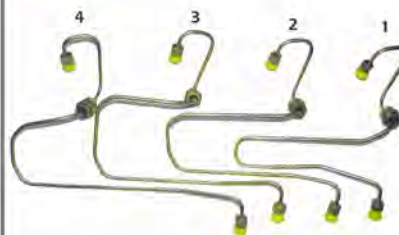

Mercedes Benz
1) 376 070 91 33 - 376 070 00 33
2) 376 070 92 33 - 376 070 01 33
3) 376 070 93 33 - 376 070 02 33
4) 376 070 94 33 - 376 070 03 33

MODELO NUEVO

Conjunto de 4 tuberías de inyección

MERCEDES BENZ 710/712/812/814/912/914

REPUESTOS

MV 0225B



Mercedes Benz
343 070 0035

Colector de rebase de inyector

MERCEDES BENZ

REPUESTOS

nl M 35

Mercedes Benz
1) 3740701233
2) 3740701333
3) 3740701433
4) 3740701533

Conjunto de 4 tuberías de inyección - Tramo externo

**MERCEDES BENZ OM364-710 PLUS
BOMBA ROTATIVA****nl M 35A**

Mercedes Benz
3660707533

Conjunto de 4 tuberías de inyección - Tramo interno

**MERCEDES BENZ OM364-710 PLUS
BOMBA ROTATIVA****nl M 35B**

Conjunto de 4 tuberías de inyección - (Internas y externas)

**MERCEDES BENZ OM364-710 PLUS
BOMBA ROTATIVA**

REPUESTOS

MV 1713

Mercedes Benz
3741807220

Tubería lubricación de turbo

MERCEDES BENZ OM 364/ 364A/ 364LA**MV 2207**

Poliamida



Tubería lubricación bomba de inyección

MERCEDES BENZ

MV 1760



Mercedes Benz
6884607062

Tubería rígida de dirección hidráulica
MERCEDES BENZ 710
OM 364 LA/ OM 364A/ OM 364

MV 1790



Mercedes Benz
6884609424

Tubería rígida dirección hidráulica
VOLKSWAGEN 15180E/17250E/19320E/23250E
CUMMINS ISCe 8.3

MV 2201



Mercedes Benz
0019972692

Tubería flexible de dirección hidráulica
MERCEDES BENZ
OM 364 LA/ OM 364A/ OM 364

MV 2202



Mercedes Benz
6884607070

Tubería rígida de dirección hidráulica
MERCEDES BENZ 710
OM 364 LA/ OM 364A/ OM 364

MV 2203



Mercedes Benz
6844607274

Tubería rígida de dirección hidráulica
MERCEDES BENZ 710
OM 364 LA/ OM 364A/ OM 364

MV 2204



Mercedes Benz
6884608565

Tubería rígida de dirección hidráulica
MERCEDES BENZ 710
OM 364 LA/ OM 364A/ OM 364

MV 2205



Mercedes Benz
6884601124

Tubería rígida de dirección hidráulica
MERCEDES BENZ 710 PLUS - OM 364

REPUESTOS

MV 3158

Tubería de freno delantero derecho salida cáliper

MERCEDES BENZ
OM 365 LA/OM 364A/OM 364**MV 3159**

Tubería de freno delantero izquierdo salida cáliper

MERCEDES BENZ
OM 365 LA/OM 364A/OM 364**MV 3160**

Tubería de freno trasero izquierdo

MERCEDES BENZ
OM 365 LA/OM 364A/OM 364**MV 3161**

Tubería de freno hidráulico

MERCEDES BENZ
OM 364A/OM 364/810/710/OM 364 LA/814**MV 3163**

Tubería de freno hidráulico

MERCEDES BENZ
OM 364A/OM 364/810/710/OM 364 LA/814**MV 3168**

Tubería rígida de freno hidráulico trasero derecho

MERCEDES BENZ
OM 365 LA/OM 364A/OM 364

REPUESTOS

MV 3565**Mercedes Benz**
6884298730

Tubería salida de compresor

MERCEDES BENZ OM364/364A/364LA**MV 3618**

Tubería rígida de compresor a conexión intermedia

MERCEDES BENZ OM364/364A/364LA

nl M 12



Mercedes Benz
1) 366 070 53 33
2) 366 070 54 33
3) 366 070 55 33
4) 366 070 56 33
5) 366 070 57 33
6) 366 070 58 33

Bosch
1) 9 994 081 231
2) 9 994 081 232
3) 9 994 081 233
4) 9 994 081 234
5) 9 994 081 235
6) 9 994 081 236

Conjunto de 6 tuberías de inyección

MERCEDES BENZ OM 366/366A ANTES DE EPA

nl M 12 MX



Mercedes Benz
1) 366 070 53 33
2) 366 070 54 33
3) 366 070 55 33
4) 366 070 56 33
5) 366 070 57 33
6) 366 070 58 33

Conjunto de 6 tuberías de inyección

MERCEDES BENZ OM 366/366A ANTES DE EPA

nl M 12 MX JA



Mercedes Benz
1) 366 070 53 33
2) 366 070 54 33
3) 366 070 55 33
4) 366 070 56 33
5) 366 070 57 33
6) 366 070 58 33

Conjunto de 6 tuberías de inyección

**MERCEDES BENZ OM 366/366A ANTES DE EPA
CON PEINES**

nl M 20

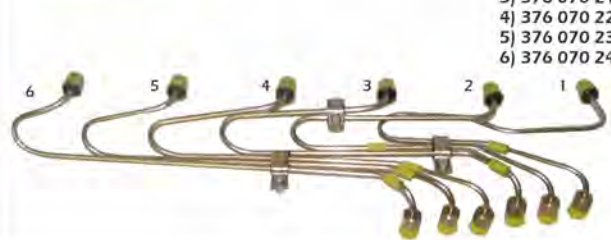

Mercedes Benz
1) 376 070 19 33
2) 376 070 20 33
3) 376 070 21 33
4) 376 070 22 33
5) 376 070 23 33
6) 376 070 24 33

Conjunto de 6 tuberías de inyección

MERCEDES BENZ OM 366LA EURO 2 - EPA 91

nl M 29 MX



**Cod. Original
Mercedes Benz**
1) A 390-070-1433
2) A 390-070-1533
3) A 390-070-1633
4) A 390-070-1733
5) A 390-070-1833
6) A 390-070-1933

Conjunto de 6 tuberías de inyección

MERCEDES BENZ OM 366 EPA 94

nl M 29 MX JA



**Cod. Original
Mercedes Benz**
1) A 390-070-1433
2) A 390-070-1533
3) A 390-070-1633
4) A 390-070-1733
5) A 390-070-1833
6) A 390-070-1933

Conjunto de 6 tuberías de inyección - Juego armado

MERCEDES BENZ OM 366 EPA 94

nl M 30 MX JA



Componentes de este conjunto:
6 M 20
6 M 21
6 MV 0430
1 SCI 188/14
1 SCI 188/8
1 SCI 188/9

Conjunto de tuberías de inyección - Tramo interno, externo, distaciador y seguros

MERCEDES BENZ OM366 EPA 91

REPUESTOS

nl M 21**Mercedes Benz**
366 070 75 33

Conjunto de tuberías de inyección tramo interno

MERCEDES BENZ OM366 LA EURO 2**MV 0430****Mercedes Benz**
364 078 00 26

Distanciador entre MV M20 Y MV M21

MERCEDES BENZ OM 366 LA EURO 2

REPUESTOS

MV 0213A**Mercedes Benz**
344 070 0235

Colector rebase de inyectores

MERCEDES BENZ**MV 0213B****Mercedes Benz**
344 070 0035

Colector rebase de inyectores

MERCEDES BENZ**MV 0235A**

350mm - Poliamida

**Mercedes Benz**
352 070 2832

De bomba de alimentación a filtro

MERCEDES BENZ**MV 0235B**

350mm - Goma

**Mercedes Benz**
352 070 2832

Reforma - De bomba de alimentación a filtro

MERCEDES BENZ**MV 0235C**

350mm - Goma enmallada

**Mercedes Benz**
352 070 2832

Reforma - De bomba de alimentación a filtro

MERCEDES BENZ**MV 0236A**

290mm - Poliamida

**Mercedes Benz**
352 070 2732

De filtro a bomba de inyección

MERCEDES BENZ

MV 0236B

290mm Goma

**Mercedes Benz**
321 070 2732

Reforma - Flexible de filtro a bomba de inyección

MERCEDES BENZ**MV 0236C**

290mm - Goma enmallada

**Mercedes Benz**
321 070 2732

Reforma - Flexible de filtro a bomba de inyección

MERCEDES BENZ**MV 0237A**

450mm Poliamida

**Mercedes Benz**
352 070 3032

De bomba de inyección a filtro retorno

MERCEDES BENZ**MV 0237B**

450mm Goma

**Mercedes Benz**
352 070 3032

Reforma - De bomba de iny. a filtro retorno

MERCEDES BENZ**MV 0237C**

450mm - Goma enmallada

**Mercedes Benz**
352 070 3032

Reforma - De bomba inyectora a filtro retorno

MERCEDES BENZ**MV 0239A**

600mm - Poliamida

**Mercedes Benz**
352 070 3632

De bomba de alimentación a filtro

MERCEDES BENZ**MV 0239B**

600mm - Goma

**Mercedes Benz**
352 070 3632

Reforma - De bomba de alimentación a filtro

MERCEDES BENZ**MV 0239C**

600mm - Goma enmallada

**Mercedes Benz**
352 070 3632

Reforma - De bomba de alimentación a filtro

MERCEDES BENZ

MV 0255A

230mm Poliamida

**Mercedes Benz**
352 070 3732

De filtro a bomba inyectora

MERCEDES BENZ**MV 0255B**

230mm - Goma

**Mercedes Benz**
352 070 0532

Reforma - De filtro a bomba inyectora

MERCEDES BENZ**MV 0255C**

230mm Goma enmallada

**Mercedes Benz**
352 070 3732

Reforma - De filtro a bomba inyectora

MERCEDES BENZ**MV 0256A**

500mm Poliamida

**Mercedes Benz**
352 070 0532

De válvula s/presión a distribuidor

MERCEDES BENZ**MV 0256B**

500mm Goma

**Mercedes Benz**
352 070 0532

Reforma - De válvula s/presión a distribución

MERCEDES BENZ**MV 0256C**

500mm - Goma enmallada

**Mercedes Benz**
352 070 0532

De válvula s/presión a distribuidor

MERCEDES BENZ**MV 0257A**

750mm Poliamida

**Mercedes Benz**
352 070 0632

De filtro doble a distribuidor

MERCEDES BENZ**MV 0257B**

750mm Goma

**Mercedes Benz**
352 070 0632

Reforma - De filtro doble a distribuidor

MERCEDES BENZ

MV 0257C

750mm Goma enmallada



Mercedes Benz
321 070 0632

Reforma - De filtro doble a distribuidor

MERCEDES BENZ

MV 1727



Mercedes Benz
376 070 0232

Alimentación bomba inyectora

MERCEDES BENZ

MV 1729



Mercedes Benz
376 987 0127

Retorno rebase de inyectores

MERCEDES BENZ

MV 1767

1600mm



Retorno rebase de inyectores

MERCEDES BENZ

MV 1770



Mercedes Benz
008 997 5482

Flexible retorno de inyectores - OHL 1420

MERCEDES BENZ

MV 1716A

Poliamida

**Mercedes Benz**
366 180 07 20

Lubricación bomba y compresor

MERCEDES BENZ**MV 1716B**

Manguera enmallada

**Mercedes Benz**
366 180 07 20

Lubricación bomba y compresor

MERCEDES BENZ**MV 1716C**

Poliamida enmallada

**Mercedes Benz**
366 180 07 20

Reforma - Lubricación bomba y compresor para altas temperaturas

MERCEDES BENZ**MV 1717A****Mercedes Benz**
376 180 0020

Lubricación del turbo (Con turbo frontal)

MERCEDES BENZ**MV 1717B****Mercedes Benz**
3761800020

Lubricación del turbo con manguera R1 - Reforma

MERCEDES BENZ**MV 1717C**

Lubricación del turbo con manguera goma remallada

MERCEDES BENZ**MV 1717D**

Lubricación del turbo con manguera goma remallada

MERCEDES BENZ**MV 1717E**

Lubricación del turbo con manguera R1 - Reforma

MERCEDES BENZ

MV 1720**Mercedes Benz**
3761807120

Lubricación del turbo con turbo central

MERCEDES BENZ OM366A/LA**MV 1721**

Lubricación del turbo con turbo lateral

MERCEDES BENZ OM366A/LK -1218**MV 1728A****Mercedes Benz**
3761807522

Retorno lubricación del turbo

MERCEDES BENZ**MV 1728B****Mercedes Benz**
3761807522

Retorno lubricación del turbo - Reforma

MERCEDES BENZ**MV 1731**

Tubería lubricación de turbo

MERCEDES BENZ**MV 1731R1**

Tubería lubricación de turbo (Goma R1)

MERCEDES BENZ**MV 1738****Mercedes Benz**
308 997 7182

Tubería de engrase de grapodina OHL (Igual a 305 997 1982)

MERCEDES BENZ**MV 1777**

Tubería descarga de lubricación de turbo

MERCEDES BENZ

MV 1784**Mercedes Benz**
376 180 7922

Tubería reforma - Descarga de lubricación turbo Om366

MERCEDES BENZ**MV 1785****Mercedes Benz**
376 180 0422
376 180 0622

Descarga de lubricación del turbo OM366 LA Euro 1

MERCEDES BENZ**MV 1792****Mercedes Benz**
496 134 0002

Tubería retorno de aceite turbo OM366 turbinado

MERCEDES BENZ**MV 1793**Diam Int 7/8"
Diam Ext 30 mm

150 mm



Manguera retorno AC OM366 turbinado

MERCEDES BENZ**MV 2225**

Tubería descarga de aceite turbo OM366 Reforma

MERCEDES BENZ

MV 1709



Mercedes Benz
364 997 8282

Tubería flexible dirección hidráulica

MERCEDES BENZ

MV 1718



Mercedes Benz
695 460 7388

Tubería rígida 1er tramo de bomba hidráulica

MERCEDES BENZ L1620 MOTOR OM366/A/LA

MV 1726



Mercedes Benz
384 460 7288
386 460 8188
(Según chasis)

Tubería de caja a flexible de presión

MERCEDES BENZ

MV 1730



Tubería tecalan (3/8), flexible para agua refrigeración de compresor

MERCEDES BENZ

MV 1733



Mercedes Benz
384 460 8624

Tubo rígido salida de bomba. Línea 366/366LA/366LK

MERCEDES BENZ

MV 1743



Mercedes Benz
384 460 7424

Tubo rígido de presión de dirección hidráulica

MERCEDES BENZ

MV 1744



Mercedes Benz
384 460 7124

Tubo rígido de alimentación de dirección hidráulica

MERCEDES BENZ

MV 1759



Mercedes Benz
390 460 8188

Tubo rígido de dirección hidráulica OM366LA

MERCEDES BENZ

MV 1768



Mercedes Benz
390 460 8771

Tubo rígido dirección hidráulica OM366LA

MERCEDES BENZ

MV 1779



Tubo salida de bomba dirección hidráulica

MERCEDES BENZ

MV 1780



Mercedes Benz
345 460 2524

Tubería alimentación bomba de dirección hidráulica

MERCEDES BENZ

MV 1782



Mercedes Benz
390 466 96662

Tubería alimentación bomba dirección hidráulica

MERCEDES BENZ

MV 1783



Mercedes Benz
390 460 8988

Tubería alimentación bomba dirección hidráulica

MERCEDES BENZ

MV 1710



Tubería rígida de accionamiento de embrague OF

MERCEDES BENZ

MV 1711



Tubería accionamiento de embrague OF1114/1214

MERCEDES BENZ

MV 1732A



Mercedes Benz
351 290 7013

Tubería rígida accionamiento de embrague OM366A-OH

MERCEDES BENZ

MV 1732B

Largo 650 mm

MV 1732C

Largo 1300 mm

MV 1732D

Largo 1700 mm

MV 1732E

Largo 1000 mm



Tubería flexible accionamiento de embrague OM366A-OH

MERCEDES BENZ

MV 1734



Tubería rígida de accionamiento de embrague OM366LA - OH

MERCEDES BENZ

MV 1735



Tubería rígida accionamiento de embrague OM366A-OH

MERCEDES BENZ

MV 1736



Mercedes Benz
382 290 7813

Tubería rígida de accionamiento de embrague OM366LA - OH

MERCEDES BENZ

MV 1739



Mercedes Benz
384 290 7213

Tubería rígida de accionamiento de embrague OM366LA - OH

MERCEDES BENZ

MV 1745**Mercedes Benz**
390 290 8314

Tubería rígida para OM366 A/LA OHL

MERCEDES BENZ**MV 1746****Mercedes Benz**
390 290 8314

Rígido para OM366A/LA - OHL

MERCEDES BENZ**MV 1747****Mercedes Benz**
390 290 8313

Tubería rígido OM366/LA - OHL

MERCEDES BENZ**MV 1748**

Tubería rígido para OM366A OHL - Largo 3800mm

MERCEDES BENZ**MV 1749****Mercedes Benz**
390 290 8313

Rígido para OM366 A/LA OHL

MERCEDES BENZ**MV 1750****Mercedes Benz**
390 290 8114

Rígido de accionamiento de embrague OM366 - OHL

MERCEDES BENZ**MV 1751****Mercedes Benz**
390 290 82--

Tubería rígida para OM366 a OHL

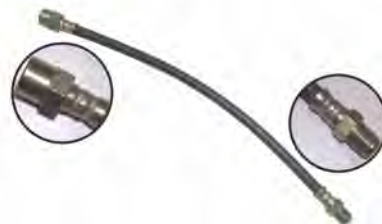
MERCEDES BENZ**MV 1752****Mercedes Benz**
376 295 7135

Tubería flexible de accionamiento de embrague OM366 - OHL

MERCEDES BENZ

MV 1753**Mercedes Benz**
390 290 8314

Tubería rígida para OM366 a OHLA

MERCEDES BENZ**MV 1754**

Tubería rígida para OM366

MERCEDES BENZ**MV 1755****Mercedes Benz**
376 295 7035

Tubería flexible de accionamiento de embrague - 210mm

MERCEDES BENZ**MV 1756****Mercedes Benz**
390 290 8913

Tubería rígida de embrague para Om366 OHL - Largo 1600mm

MERCEDES BENZ**MV 1781**

Tubería flexible accionamiento de embrague - 300mm

MERCEDES BENZ**MV 1796**

Tubería rígida de accionamiento de embrague

MERCEDES BENZ**MV 2212****Mercedes Benz**
376 295 7035

Cañería para vehículos c/motor OM 366LA

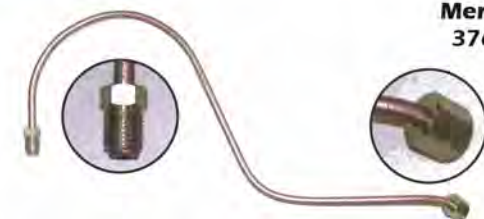
MERCEDES BENZ**MV 2213****Mercedes Benz**
376 295 7035

Cañería para vehículos c/motor OM 366LA

MERCEDES BENZ

MV 1761



Cañería para caja Allison

MERCEDES BENZ

MV 1762



Mercedes Benz
390 270 7396

Cañería para caja Allison

MERCEDES BENZ

MV 1763



Mercedes Benz
390 270 7196

Cañería para caja Allison

MERCEDES BENZ

MV 1764



Mercedes Benz
390 270 7496

Cañería para caja Allison

MERCEDES BENZ

MV 1765



Mercedes Benz
390 270 7596

Cañería para caja Allison

MERCEDES BENZ

MV 1766



Mercedes Benz
325 997 0782

cañería para caja Allison

MERCEDES BENZ

MV 1714
Mercedes Benz
366 070 0081

Tubería múltiple de admisión a TPS bomba inyectora

MERCEDES BENZ**MV 1715**

Tubería para cilindro neumático alta y baja eje HI5

MERCEDES BENZ**MV 1722**
Mercedes Benz
376 200 7152

Tubería refrigeración de compresor WABCO. Para OM366 / LA OHL

MERCEDES BENZ**MV 1723**
Mercedes Benz
376 200 7252

Unión doble para base de termostato p/ compresor WABCO - OM366 LA OHL

MERCEDES BENZ**MV 1724**

Tubería de acople freno motor OM366

MERCEDES BENZ**MV 1724B**

Manguera remallada



Tubería acople freno OM366 con manguera remallada

MERCEDES BENZ**MV 1774**

Tubería refrigeración del compresor Knor entrada

MERCEDES BENZ**MV 1775**

Tubería refrigeración del compresor Knor salida

MERCEDES BENZ

MV 1786

Ø 18mm



Mercedes Benz
372 200 7056

Tubería calefacción

MERCEDES BENZ

MV 1787

Ø 28mm



Mercedes Benz
372 200 7056

Tubería calefacción

MERCEDES BENZ

MV 1791



Mercedes Benz
3685010626
3685010026

Tubería rígida de agua del motor al radiador de aceite de transmisión

MERCEDES BENZ OH 1618/1518/1622
OM366

MV 1794



Tubería de compresor a codo admisión turbinado kit

MERCEDES BENZ

MV 1737



Mercedes Benz
390 420 8497

Reforma tubería rígida de válvula gobernadora a conexión intermedia

MERCEDES BENZ

MV 1740



Mercedes Benz
364 997 9482

Tubería flexible salida de compresor OHL C/Teflón interno y malla de acero inoxidable

MERCEDES BENZ

MV 1740 P 11



Flexible salida de compresor OHL con poliamida remallada

MERCEDES BENZ

MV 1740R1

Manguera R1



Mercedes Benz
364 997 9482

Tubería flexible salida de compresor OHL con manguera R1 c/ malla de acero interna

MERCEDES BENZ

MV 3534**Mercedes Benz**
386 990 7288

Caño conector rígido salida de compresor - Corto

MERCEDES BENZ 1418/ 1620 / 1215 / 1218
1621 / MOTOR OM366**MV 3534A****Mercedes Benz**
693 990 7088

Caño conector rígido salida de compresor - Largo

MERCEDES BENZ 1418/ 1620 / 1215 / 1218
1621 / MOTOR OM366**MV 3536**

Salida de compresor Cont. MV 3554

MERCEDES BENZ**MV 3538****Mercedes Benz**
390 420 7137

Tubería salida de compresor tramo 2 OM366 A/LA

MERCEDES BENZ**MV 3539**

Tubería reforma salida de compresor

MERCEDES BENZ**MV 3540**

Tubería reforma rígido a válvula gobernadora

MERCEDES BENZ

MV 3549A**Mercedes Benz**
351 420 9726

Tubería salida de compresor OH

MERCEDES BENZ**MV 3549B****Mercedes Benz**
351 420 9726

Tubería a válvula gobernadora OH

MERCEDES BENZ**MV 3549C****Mercedes Benz**
351 420 9726

Tubería a válvula gobernadora OH con manguera R5

MERCEDES BENZ**MV 3550****Mercedes Benz**
386 420 8736

Tubería rígido de compresor

MERCEDES BENZ**MV 3553A**

Tubo rígido salida de compresor OHL

MERCEDES BENZ**MV 3553B**

Tubo rígido salida de compresor OHL

MERCEDES BENZ**MV 3553C**

Tubo rígido salida de compresor OHL

MERCEDES BENZ**MV 3554****Mercedes Benz**
390 420 7026

Tubo rígido a válvula gobernadora para motor OM366A/OH

MERCEDES BENZ

MV 3557



Tubería reforma compresor OH

MERCEDES BENZ

MV 3558



Reforma compredor OH

MERCEDES BENZ

MV 3559



Reforma salida de compresor

MERCEDES BENZ

MV 3560A

1560 mm.



Mercedes Benz
6954202628
6954209026
6954209028
6934206226

Tubería rígida salida de compresor - Salida APU

MERCEDES BENZ L1218 / 1620 / 1720

MV 3560B

1800 mm.



Mercedes Benz
6934209936
6954202528

Tubería rígida salida de compresor

MERCEDES BENZ L1218 / L1418 / L1620

MV 3563



Reforma compresor

MERCEDES BENZ

MV 3564



Mercedes Benz
3904207236

Compresor a válvula gobernadora - OH1315-1320

MERCEDES BENZ

MV 3567



Mercedes Benz
3844207026

Salida de compresor - OF1215

MERCEDES BENZ

MV 3568**Mercedes Benz**
3844203436

Rígido de compresor

MERCEDES BENZ**MV 3569****Mercedes Benz**
390 420 8349

Tubería salida de compresor

MERCEDES BENZ**MV 3578****Mercedes Benz**
4961340032

Tubería rígida salida de compresor

MERCEDES BENZ 1718/1722/1723
OM366LK**MV 3590A****Mercedes Benz**
394 420 7026

Tubería salida de compresor 1215

MERCEDES BENZ**MV 3590B****Mercedes Benz**
394 420 7026

Tubería salida de compresor con rulo doble

MERCEDES BENZ**MV 3591**

Tubería flexible freno delantero

MERCEDES BENZ**MV 3593A**

Tubería flexible freno trasero

MERCEDES BENZ**MV 3593B**

Tubería flexible freno trasero con manguera R1

MERCEDES BENZ

MV 3594**Mercedes Benz**
3844207548
3894205648
3844209848

Tubería flexible pulmón freno trasero

MERCEDES BENZ L1620 MOTOR OM366
L1933/L1938 OM447**MV 3616****Mercedes Benz**
688 420 4036

Tubo rígido de compresor a conexión intermedia

MERCEDES BENZ**MV 3617****Mercedes Benz**
682 420 8836

Tubo rígido de compresor a conexión intermedia

MERCEDES BENZ**nl M 13****Mercedes Benz**
6 1) 476 070 01 33
2) 476 070 02 33
3) 476 070 03 33
4) 476 070 04 33
5) 476 070 05 33
6) 476 070 06 33

Conjunto de 6 tuberías de inyección

MERCEDES BENZ 1938/1941/1935/2625

MV 1741**Mercedes Benz**
476 180 7622

Salida de filtro

MERCEDES BENZ**MV 1742****Mercedes Benz**
476 180 7722

De inyector a tanque conector de retorno

MERCEDES BENZ**MV 1758****Mercedes Benz**
476 180 0020

Entrada a bomba de alimentación

MERCEDES BENZ**MV 1797****Mercedes Benz**
001 997 2752

Flexible de dirección hidráulica

MERCEDES BENZ

MV 1641

Mercedes Benz
6952950035
6952957035

Tubería accionamiento de embrague

MERCEDES BENZ 1634/1938 MOTOR OM447LA**MV 1755**

Mercedes Benz
39762957035

Flexible accionamiento de embrague 210mm

MERCEDES BENZ OM366LK/OM366LA/OM366A**MV 1769A**

Mercedes Benz
4762000058
4762000158

Tubería de refiregeración de purga

MERCEDES BENZ 1938**MV 1772**

Mercedes Benz
4272000152
4272000752

Cañería refrigeración de compresor

MERCEDES BENZ**MV 1789**

Mercedes Benz
4272000052
4272000452

Cañería de refrigeración de compresor

MERCEDES BENZ**MV 2224**

Mercedes Benz
4572001452

Tubería de refrigeración de compresor

MERCEDES BENZ

MV 2215A

Tubería de purga de agua

MERCEDES BENZ OM 447**MV 2243**Mercedes Benz
4760100070

Tubería para purga de aire Top Brake

**MERCEDES BENZ 1938/ O 400
MOTOR OM 447LA****MV 3594**Mercedes Benz
3844207548
3894205648
3844209848

Tubería flexible pulmón freno trasero

**MERCEDES BENZ L1620 MOTOR OM366
L1933/L1938 OM447****MV 3680**Mercedes Benz
6954202328
6964207336

Tubería rígida de compresor

MERCEDES BENZ 1634 MOTOR OM447**MV 3682**Mercedes Benz
6954207436
6954208228

Tubería rígida de compresor

MERCEDES BENZ 1634 MOTOR OM447

REPUESTOS

nl M 14**Mercedes Benz**

- 1) 476 070 02 33
- 2) 476 070 03 33
- 3) 476 070 04 33
- 4) 476 070 05 33
- 5) 476 070 06 33

Conjunto de 5 tuberías de inyección

MERCEDES BENZ 1638/1634/1630

REPUESTOS

MV 1799**Mercedes Benz**

476 180 7022

Lubricación turbo

MERCEDES BENZ

REPUESTOS

MV 1797**Mercedes Benz**

001 997 2752

Lubricación turbo

MERCEDES BENZ

MV 1755

210mm

**Mercedes Benz**
376 295 7035

Flexible accionamiento de embrague

MERCEDES BENZ**MV 1769B****Mercedes Benz**
475 200 0258

Cañería de purga

MERCEDES BENZ**MV 1772****Mercedes Benz**
427 200 0152
427 200 0752

Cañería refrigeración de compresor

MERCEDES BENZ**MV 1789****Mercedes Benz**
427 200 0052
427 200 0452

Refrigeración de compresor

MERCEDES BENZ**MV 2215B**

Tubería de purga de agua

MERCEDES BENZ

REPUESTOS

MV 2220B



Tubería recta de purga de agua

MERCEDES BENZ

REPUESTOS

MV 3591

Manguera sintética



Flexible freno delantero

MERCEDES BENZ

MV 3593A

Manguera sintética

MV 3593B

Manguera R1



Flexible freno trasero

MERCEDES BENZ

REPUESTOS

nl M 22



Conjunto de tuberías de inyeccion

MERCEDES BENZ

nl M 34



Mercedes Benz

4570700933

4570701033

4570701533

4570701733

4570701313

Conjunto de tuberías de inyeccion

MERCEDES BENZ 1634/O400 OM457 ELECTRÓNICO

MV 2235 CON BULONES**MV 2235A** SIN BULONESMercedes Benz
457 090 06 76

Tuberia de Filtro de Combustible al Block

MERCEDES BENZ OM457 O500 ELECTRONICO**MV 2236** CON BULONES**MV 2236A** SIN BULONESMercedes Benz
457 090 08 76

Tuberia de Filtro a Bomba de Llenado de Circuito

MERCEDES BENZ OM457 O500 ELECTRONICO**MV 2237** CON BULONES**MV 2237A** SIN BULONESMercedes Benz
457 090 15 76

Tuberia de la Bomba Alimentadora al Block

MERCEDES BENZ OM457 O500 ELECTRONICO**MV 2238** CON BULONES**MV 2238A** SIN BULONESMercedes Benz
457 090 17 76

Tuberia de Valvula Exagonal Block a Bomba Alimentadora

MERCEDES BENZ OM457 1634 ELECTRONICO**MV 2239** CON BULONES**MV 2239A** SIN BULONESMercedes Benz
457 090 31 76

Tuberia de Bomba Alimentadora al Filtro

MERCEDES BENZ OM457 1634 ELECTRONICO**MV 2240** CON BULONES**MV 2240A** SIN BULONESMercedes Benz
457 090 35 76

Tuberia de Bomba Alimentadora al Filtro

MERCEDES BENZ OM457 1634 ELECTRONICO**MV 2241** CON BULONES**MV 2241A** SIN BULONESMercedes Benz
457 090 36 76

Tuberia de Valvula Exagonal a Bomba Alimentadora

MERCEDES BENZ OM457 1634 ELECTRONICO**MV 2248** CON BULONES**MV 2248A** SIN BULONESMercedes Benz
A4570901676

Tubería flexible de filtro a block de motor

MERCEDES BENZ 1938 - OM457LA ELECTRÓNICO

MV 2249

Mercedes Benz
A4570703238
A4570900476
A4570703338
A4570702438
A4570700438

Tubería flexible de retorno de combustible

MERCEDES BENZ 1938 - AXOR - OM457**MV 2350**

Mercedes Benz
4571800822

Tubería rígida descarga de turbo

MERCEDES BENZ 1938E**MV 2220A**

Mercedes Benz
Cod. Ant: 457 010 01 55
Cod. Nvo: 457 200 04 58

Tubería recta de purga de agua

MODELO O 400 - MOTOR OM 457**MV 2220C**

Mercedes Benz
A4572000558

Tubería recta de purga de agua con curva final

MERCEDES BENZ OM457 ELECTRONICO

REPUESTOS

MV 2243



Mercedes Benz
4760100070

Tubería para Purga de Aire Top Brake

MERCEDES BENZ OM457

MV 2244



Mercedes Benz
A 457 010 0355

Colector purga de aire

**MERCEDES BENZ 1938
MOTOR OM457 ELECTRONICO**

MV 2247



Tubería de refrigeración de compresor

MERCEDES BENZ OM457

MV 2257



Mercedes Benz
A45720022052

Tubería de refrigeración de compresor

MERCEDES BENZ 0500 - 16434 - 1938 / OM457

MV 2258



Mercedes Benz
4602000252

Tubería de refrigeración de compresor

**MERCEDES BENZ 0500 / 1634 / 1938
MOTOR OM457**

REPUESTOS

MV 1672

Largo 6150 mm



Mercedes Benz
9585530482
9585530582

Tubería flexible levanta cabina

MERCEDES BENZ AXOR 2035 OM457LA

MV 1673

Largo 4480 mm



Mercedes Benz
9405530582

Tubería flexible levanta cabina

MERCEDES BENZ AXOR 1933 OM926

MV 2246



Mercedes Benz
4572001452
4602000152

Tubería de refrigeración de compresor

MERCEDES BENZ OM457/447/449

MV 2299



Mercedes Benz
A9584202545

Tubería rígida de compresor

MERCEDES BENZ AXOR 2035/2036 OM457LA

MV 3526

350mm - MANGUERA R1

Mercedes Benz
A 665 429 76 35



Rosca M26x1,5mm
Conexion asiento conico



Flexible de compresor, teflón interno

**MERCEDES BENZ OM457 - OF 1417/1418
OM904LA**

MV 3526 P11

350mm - POLIAMIDA REMALLADA

Mercedes Benz
A 665 429 76 35



Rosca M26x1,5mm
Conexion asiento conico



Flexible de compresor, teflón interno

**MERCEDES BENZ OM457 - OF 1417/1418
OM904LA**

MV 3526T

350mm - TEFLÓN Y MALLA DE
ACERO INOXIDABLE

Mercedes Benz
A 665 429 76 35



Rosca M26x1,5mm
Conexion asiento conico



Flexible de compresor, teflón interno

**MERCEDES BENZ OM457 - OF 1417/1418
OM904LA**

MV 3626



Salida de compresor a válvula gobernadora - Electrónico

MERCEDES BENZ OM457

MV 3628



Mercedes Benz
6934209936

Rígido de compresor a conexión intermedia

MERCEDES BENZ OM457

MV 3631



Serpentina de compresor M.Benz OM457 (O400) - Electrónico

MERCEDES BENZ OM457

REPUESTOS

MV 3641**Mercedes Benz**
A6644200236

Tubería rígida serpentina de compresor

MERCEDES BENZ 1938E / O400 - OM457A**MV 3654****Mercedes Benz**
A3824204228
6344209229
6344209631

Tubería serpentina de compresor

MERCEDES BENZ - O500 RSD / MOTOR OM457**MV 3670****Mercedes Benz**
6954200136
6954207328
6954200270

Tubería rígida de compresor

MERCEDES BENZ 1634 MOTOR OM457**MV 3684**

2,55 M

Tubería rígida de compresor

MERCEDES BENZ O500 RSD2436 OM457**MV 3685****Mercedes Benz**
6344209029
3824204228

Tubería rígida serpentina de compresor

MERCEDES BENZ O500 OM457**MV 3686A**

Tubería rígida de compresor

MERCEDES BENZ O500 RSD 2036/2236/2436/30 OM457**MV 3686B**

Tubería rígida de compresor

MERCEDES BENZ O500 RSD 2036/2236/2436/30 OM457**MV 3686C****Mercedes Benz**
6344207335

Tubería rígida de compresor

MERCEDES BENZ O500 RSD 2036/2236/2436/30 OM457

MV 3686D

Tubería rígida de compresor

MERCEDES BENZ O500 RSD 2036/2236/2436/30 OM457

MV 3686E

Tubería rígida de compresor

MERCEDES BENZ O500 RSD 2036/2236/2436/30 OM457

MV 3686F

Tubería rígida de compresor

MERCEDES BENZ O500 RSD 2036/2236/2436/30 OM457

MV 3686G

5° Tramo

Mercedes Benz
3844204228

Serpentina de compresor - 5° Tramo

MERCEDES BENZ O500 RSD 2036/2236/2436/30 OM457
OF1519/OF1621 OM924**NL M 36 JA**

Conjunto de 5 Tuberías de Inyección Ssang Yong Musso - ARMADO

MERCEDES BENZ

nl M 31

DE BOMBA DE ALTA
PRESIÓN A RAIL



Mercedes Benz
A6110701433

Juego de 5 tubos de inyección

MERCEDES BENZ OM611LA SPRINTER 313 CDI

nl M 32

DE RAIL A INYECTOR



Mercedes Benz
A6110700033

Tubo de bomba de alta presión

MERCEDES BENZ OM611LA SPRINTER 313 CDI

MV 2233



Flexible colector de descarga para rebase de inyectores (Ignifugo)
**MERCEDES BENZ SPRINTER 208/311/313/413/416 CDI
OM611LA 2.1/2.2/2.7**

MV 2233A



Tuberia flexible retorno de inyectores
**MERCEDES BENZ E-SERISI/SPRINTER/VIANO/VITO CLASEV
CLASE S MOTOR OM611**

Mercedes Benz
6110704532
6110706032
6280701532
6110700032
6110702432

MV 2252



Tuberia flexible de combustible en poliamida conformad
a de filtro de combustible a bomba de baja presión
**MERCEDES BENZ SPRINTER
208 311 313 413 416 CDI MOTOR OM611LA 2.1/2.2/2.7**

Mercedes Benz
6110702032

MV 2253



Tuberia flexible de combustible en poliamida conformada
de bomba de alta presión a valvula reguladora de presión
**MERCEDES BENZ SPRINTER
208 311 313 413 416 CDI MOTOR OM611LA 2.1/2.2/2.7**

Mercedes Benz
A6110702932

MV 2254



Tuberia flexible de combustible en poliamida conformada
de bomba de baja a bomba de alta y a sensor de presión
**MERCEDES BENZ SPRINTER
208 311 313 413 416 CDI MOTOR OM611LA 2.1/2.2/2.7**

Mercedes Benz
6110707632
6110706432

MV 2255



Tuberia flexible de combustible en poliamida
conformada de bomba de baja presión a bomba de alta presión
**MERCEDES BENZ SPRINTER
208 311 313 413 416 CDI MOTOR OM611LA 2.1/2.2/2.7**

Mercedes Benz
6110701932

MV 2256



Tuberia rigida de agua
MERCEDES BENZ SPRINTER 413 CDI - OM611

Mercedes Benz
9018302715

REPUESTOS

MV 2270**Mercedes Benz**
6510700132

Tubería flexible retorno de inyectores

MERCEDES BENZ SPRINTER 515 CDI

REPUESTOS

MV 2311**Mercedes Benz**
6511800722

Tubería rígida para lubricación del turbo

MERCEDES BENZ SPRINTER 515 MOTOR OM651

REPUESTOS

nI M 16**Mercedes Benz**
1) 6160701633
2) 6160701733
3) 6160701833
4) 6160701933

Conjunto de 4 tuberías de inyección

MERCEDES BENZ 180D

REPUESTOS

M 23Mercedes Benz
A9060701433

Conjunto de tuberías de inyección

MERCEDES BENZ 904 ELECTRÓNICO (4 CILINDROS)**M 23 A**Mercedes Benz
A9060701433

Tubo de inyección armado con seguro

MERCEDES BENZ OM904 / Om906**M 24**Mercedes Benz
A9060701433

Conjunto de tuberías de inyección

MERCEDES BENZ 906 ELECTRÓNICO (6 CILINDROS)

REPUESTOS

MV 0535M

Manguera sintética para protección de caños de combustible MV 2217, MV 2218 (venta por rollo x 10mts)

MERCEDES BENZ OM 904 / 906**MV 2217 CON BULONES**
MV 2217A SIN BULONESMercedes Benz
Anterior:
904 090 06 76
Actual:
904 090 09 76

Tubería completa de combustible de block a filtro - largo

MERCEDES BENZ OM 904 / 906**MV 2218 CON BULONES**
MV 2218A SIN BULONESMercedes Benz
9060901376

Tubería completa de combustible de filtro a bomba alimentadora

MERCEDES BENZ OM 904 / 906**MV 2219**Mercedes Benz
A9060701832
A9060703432

Tubería de filtro de combustible a enfriador de PLD - Poliamida conformada

MERCEDES BENZ 1315 / 1618 / 1624 / 1725
MOTOR OM 904 / OM 906

MV 2228Mercedes Benz
A6934707064

Tubería flexible de combustible

MERCEDES BENZ OM 906 / OF 1417 / O 500**MV 2242 CON BULONES**
MV 2242A SIN BULONESMercedes Benz
Anterior:
9060903376
9060901276

Tubería de Filtro a Bomba Alimentadora a válvula hexagonal

MERCEDES BENZ OM 906 / 1624 / 1725**MV 2250**Mercedes Benz
9060702032
9060701732

Tubería flexible de combustible en poliamida conformada

MERCEDES BENZ OH1618 O500 OM 904/906/924/926**MV 2260**Mercedes Benz
9040700233
9040700433

Tubería flexible retorno de inyectores

MERCEDES BENZ 1115 MOTOR OM904**MV 2261**Mercedes Benz
6934607888

Tubería rígida de combustible de bomba a flexible

MERCEDES BENZ 1215C / MOTOR OM904**MV 2262**Mercedes Benz
3684701824

Tubería rígida de combustible corto

MERCEDES BENZ 1518/1519/1618/1620 OM904/924**MV 2263**Mercedes Benz
3684702024

Tubería rígida de combustible larga

MERCEDES BENZ 1518/1519/1618/1620 OM904/924**MV 2265**Mercedes Benz
9060702033
9060702533

Tubería retorno de inyectores

MERCEDES BENZ OF1732/O500 - OM906/926

MV 2227**Mercedes Benz**
A9041800620

Tubería de lubricación de turbo

MERCEDES BENZ**MV 1481****Mercedes Benz**
A9589970154

Tubería flexible de presión de bomba a dirección hidráulica

MERCEDES BENZ AXOR 1933 / 2035S / 2040S
2044S / 2640S / 2644S MOTOR OM926**MV 1482****Mercedes Benz**
3829970452

Tubería flexible de dirección hidráulica

MERCEDES BENZ 1618 MOTOR OM904**MV 1791****Mercedes Benz**
3685010626
3685010026

Tubería rígida de agua del motor al radiador de aceite de transmisión

MERCEDES BENZ OH 1618/1518/1622
OM904**MV 2290A**

300mm.



Tubería flexible corta, enfriador de agua

MERCEDES BENZ OH1315L / OH1315SB OM 904

MV 2290B

600mm.



Tubería flexible larga, enfriador de agua

MERCEDES BENZ OH1315L / OH1315SB OM 904**MV 2291****Mercedes Benz**
3685000094

Tubería rígida T para unión de tubos de refrigeración de agua

MERCEDES BENZ 1618 OM904**MV 2295****Mercedes Benz**
9062037602
9062032402

Tubería refrigeración de compresor a bomba de agua

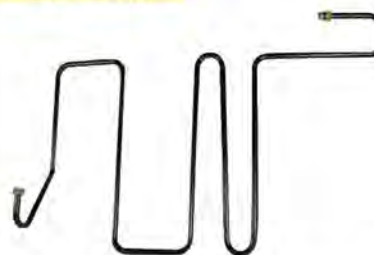
1624 MOTOR OM906 - 1933/2035 MOTOROM926**MV 2296****Mercedes Benz**
9584209326
9584203430
6944204626

Tubería rígida serpentina. Aire compresor 2do tramo.

MERCEDES BENZ 1624L / OM906
AXOR 1933/2035 OM926**MV 2297****Mercedes Benz**
6934202526
6934207826
6944200426

Tubería rígida salida de secador de aire

MERCEDES BENZ L1622/L1624 OM924 EURO 5**MV 2298****Mercedes Benz**
9584200633

Tubería rígida salida aire compresor 1er tramo

MERCEDES BENZ AXOR 1933/2533/2625
MOTOR OM926LA**MV 4211****Mercedes Benz**
A9041301457
A9041304057
A9041300557

Juego de flexibles, aspiración

MERCEDES BENZ OH1618 MOTOR OM904

MV 1671

Largo 4430 mm



Mercedes Benz
9405530682

Tubería flexible levanta cabina

MERCEDES BENZ AXOR 1933
MOTOR OM926

MV 1674

Largo 2560 mm



Mercedes Benz
9405532782

Tubería flexible levanta cabina Mercedes Benz Axor 1933

MERCEDES BENZ AXOR 1933
MOTOR OM926

MV 2229 CON BULONES

MV 2229A SIN BULONES



Mercedes Benz
A9042030102

Flexible de refrigeración de compresor

MERCEDES BENZ OM904/OM924 - OF 1417/712

MV 2230 CON BULONES

MV 2230A SIN BULONES



Mercedes Benz
A9062030102

Flexible de refrigeración de compresor

MERCEDES BENZ OM906 - 1315/O500

MV 2231 CON BULONES

MV 2231A SIN BULONES



Mercedes Benz
A9062030402

Flexible y Rígido de refrigeración de compresor

MERCEDES BENZ OM906 - 1315/O 500

MV 2231AR



Flexible remallado y rígido de refrigeración de compresor

MERCEDES BENZ 1315 / O500 MOTOR OM906

MV 2232



Mercedes Benz
A9049970282

Manguera de descarga de aceite turbo

MERCEDES BENZ OM904

MV 2251



Mercedes Benz
9584200031

Tubería rígida de freno

MERCEDES BENZ ATEGO 1718/1723/1725/1726/2423
2425/2426/2428 - OM904 / OM906

MV 3526

350mm - MANGUERA R1

Mercedes Benz
A 665 429 76 35



Flexible de compresor, teflón interno

MERCEDES BENZ OM457 - OF 1417/1418
OM904LA

MV 3526T

350mm - TEFLÓN Y MALLA DE ACERO INOXIDABLE

Mercedes Benz
A 665 429 76 35



Flexible de compresor, teflón interno

MERCEDES BENZ OM457 - OF 1417/1418
OM904LA

MV 3526AT

400mm - TEFLÓN Y MALLA DE ACERO INOXIDABLE

Mercedes Benz
A 665 429 76 35

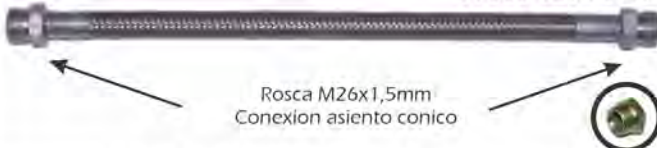

Flexible de compresor, teflón interno

MERCEDES BENZ OM457 - OF 1417/1418
OM904LA

MV 3643

LONGITUD: 350mm



Rígido salida de compresor - Empalme APU

MERCEDES BENZ - OF 1417-1418 OM904LA

Código Actual:
A 384 420 14 26
Código Anterior:
A 384 420 37 36

MV 3644

Longitud: 885 mm



Rígido salida de compresor - Primer Tramo

MERCEDES BENZ - OH 1618 / MOTOR OM904LA

Mercedes Benz
A 368 420 14 28

MV 3644A



Rígido salida de compresor - Tramo 1

MERCEDES BENZ - OHL1618 MOTOR OM904
OH1621-1721 MOTOR OM924

Mercedes Benz
A3684200932

MV 3644R

700mm



Tubería rígida salida de compresor - Reforma - 1er tramo

MERCEDES BENZ OHL 1618 MOTOR OM904
OH161-1721 MOTOR OM924

REFORMA

Mercedes Benz
A3684200932R
A3684201428R

MV 3645



Rígido de compresor a gobernador

MERCEDES BENZ - OF 1417-1418 / MOTOR OM904LA

Mercedes Benz
A 384 420 18 26

MV 3645R**REFORMA**Mercedes Benz
A3684203428R

Rígida de compresor "REFORMA" 3er tramo

MERCEDES BENZ OH1618 MOTOR OM904**MV 3645A**

Longitud: 1610 mm

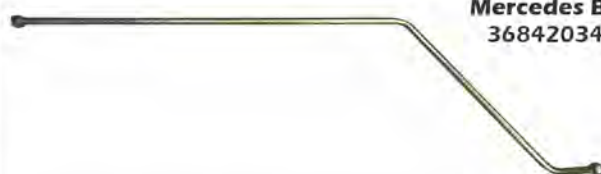
Mercedes Benz
3684203428

Tubería rígida de compresor - Tercer tramo

MERCEDES BENZ OH 1618 / MOTOR OM904**MV 3646**

Longitud: 1952 mm

Mercedes Benz
A3684203528

Tubería rígida de compresor - Cuarto tramo

MERCEDES BENZ OH 1618 / MOTOR OM904LA**MV 3647**

Longitud: 1595mm

Mercedes Benz
A3684203628

Tubería rígida de compresor - Quinto tramo

MERCEDES BENZ OH 1618 / MOTOR OM904LA**MV 3648**

Longitud: 1625mm

Mercedes Benz
A3684203728

Tubería rígida de compresor - Sexto tramo

MERCEDES BENZ OH 1618 / MOTOR OM904LA**MV 3648R****REFORMA**

Longitud: 1800mm

Mercedes Benz
A3684203728/R

Tubería rígida de compresor - Sexto tramo

MERCEDES BENZ OH 1618 / MOTOR OM904LA**MV 3649**

Longitud: 1226mm

Mercedes Benz
A3684205628

Tubería rígida de compresor - Séptimo tramo

MERCEDES BENZ OH 1618 / MOTOR OM904LA**MV 3650**

Longitud: 1964mm

Mercedes Benz
A3684207628

Rígido de compresor - Segundo tramo

MERCEDES BENZ OH 1618 / MOTOR OM904LA

MV 3650A

Longitud: 4300mm

MV 3650B

Longitud: 4800mm

REFORMA



Mercedes Benz
A3684207628

Flexible de goma salida entrada de gobernador

MERCEDES BENZ OH1618 MOTOR OM904

MV 3650C

Largo: 1890mm



Mercedes Benz
A3684203132

Tubería rígida de compresor OM924 EURO V - OH1621-1721 "Tramo 2"

MERCEDES BENZ OH1621/1721 OM924 EURO V

MV 3650D



Mercedes Benz
A3844207933

Tubería rígida salida de compresor

MERCEDES BENZ OF 1621 OM924

MV 3650DR



REFORMA

Rígido compresor OF1519 OM924 EV - OF1621 OM924 EV "REFORMA"

MERCEDES BENZ OF1519/OF1621 OM924 EV

MV 3650R



REFORMA

Mercedes Benz
A3684203132R

Tubería rígida de compresor "REFORMA" Tramo 2

MERCEDES BENZ OH1621-1721 MOTOR OM924

MV 3651



Mercedes Benz
A3824204828
A3824207429

Tubería serpentina de compresor

MERCEDES BENZ - O500M / MOTOR OM906

MV 3652



Mercedes Benz
A3824204728

Tubería serpentina de compresor

MERCEDES BENZ - O500M / MOTOR OM906

MV 3653



Mercedes Benz
A3824201036

Tubería serpentina de compresor

MERCEDES BENZ O500M / MOTOR OM906

MV 3655

320mm



Roscas: 22x1,5mm

Tubería rígida salida gobernador

MERCEDES BENZ 1315 - OM904LA**MV 3655A**

2300mm



Roscas: 22x1,5mm

Tubería flexible de teflon, reforma salida gobernador hacia compresor

MERCEDES BENZ 1315 - OM904LA**MV 3656**MERCEDES BENZ
9584200231

Tubería rígida de compresor - 1º tramo

**MERCEDES BENZ ATEGO 1718/1723/1725
MOTOR OM904LA****MV 3657**MERCEDES BENZ
9584200131

Tubería rígida serpentina de compresor - 2º tramo

MERCEDES BENZ ATEGO 1725 OM904LA**MV 3657A**MERCEDES BENZ
9584202137

Tubería rígida serpentina de compresor - 3º tramo

MERCEDES BENZ ATEGO 1726 OM904LA**MV 3658**

2650 mm.



Tubería rígida recta de compresor - 4º Tramo

MERCEDES BENZ OH1718 / MOTOR OM904LA**MV 3658A**

2962 mm.

Mercedes Benz
3684201630

Tubería rígida recta de compresor 4º tramo

**MERCEDES BENZ OHL1718 OM904
OH1621/1721 OM924 EURO 5****MV 3659**Mercedes Benz
3904200849

Tubería serpentina 1 rulo - Reforma compresor

MERCEDES BENZ 1315 MOTOR OM904

MV 3671**Mercedes Benz**
6284300270Cámara compresor
MERCEDES BENZ 1634EL- O500
MOTOR OM904/906/457**MV 3672****Mercedes Benz**
6954203528
6954207528Tubería rígida de compresor - 2do Tramo
MERCEDES BENZ 1634 MOTOR OM457**MV 3674****Mercedes Benz**
3824200933Tubería rígida de compresor - 1er tramo
MERCEDES BENZ O500U - OM926**MV 3675****Mercedes Benz**
3824208831
3824204735Tubería rígida de compresor - Ultimo tramo
MERCEDES BENZ O500U - OM906/OM926**MV 3676****Mercedes Benz**
3824204835Tubería rígida intermedia de compresor desde serpentina
MERCEDES BENZ O500U - OM906/OM926**MV 3677****Mercedes Benz**
3824201728Tubería rígida del flexible al silenciador - c/fuelle
MERCEDES BENZ O500U MOTOR OM906
O500 MOTOR OM457 - O500U MOTOR OM926**MV 3685****Mercedes Benz**
6344209029
3824204228Tubería rígida serpentina de compresor
MERCEDES BENZ O500U OM926 EV**MV 3703****Mercedes Benz**
9584203829Tubería rígida serpentina corta de compresor
MERCEDES BENZ AXOR 1933 OM926
AXOR 2035/2040 OM457 EURO 3

MV 3711



Mercedes Benz
3844208429

Tuberia rigida serpentina compresor - 1er tramo

MERCEDES BENZ OF1519 / OF1621 OM926 - EURO 5

MV 3712



Mercedes Benz
3844208629

Tuberia rigida serpentina compresor - 2do tramo

MERCEDES BENZ OF1519 / OF1621 OM926 - EURO 5

MV 3713



Mercedes Benz
3844208529

Tuberia rigida serpentina compresor - 3er tramo

MERCEDES BENZ OF1519 / OF1621 OM926 - EURO 5

MV 3714



Mercedes Benz
3844208729

Tuberia rigida serpentina compresor - 4to tramo

MERCEDES BENZ OF1519 / OF1621 OM926 - EURO 5

MV 3715



Mercedes Benz
3824204228

Tuberia rigida serpentina compresor - 5to tramo

MERCEDES BENZ OF1519/OF1724 OM926 - EURO 5
OF1621 OM924 - EURO 5 / OF1724 OM457LA

MV 3716



Mercedes Benz
3844208829

Tuberia rigida serpentina compresor - 6to tramo

MERCEDES BENZ OF1519 / Of1621
OM926 - EURO 5

MV 3717



Mercedes Benz
3844208929

Tuberia rigida serpentina compresor - 7mo tramo

MERCEDES BENZ OF1519 / OF1621
OM926 - EURO 5

MV 3718A

Largo: 1550mm



Mercedes Benz
3844200197

Tuberia rigida de compresor - 1°TRAMO

MERCEDES BENZ 1721/1722 MOTOR OM924/924LA
EURO 5

MV 3718B

Largo: 1410mm



Mercedes Benz
3844200231

Tuberia rigida salida de compresor - 2º TRAMO
MERCEDES BENZ 1721/1722 MOTOR OM924/924LA
EURO 5

MV 3718C

Largo: 480mm



Mercedes Benz
3844200331

Tuberia rigida serpentina compresor 3º tramo
MERCEDES BENZ 1721/1722 MOTOR OM924/924LA
EURO 5

MV 3718D

Largo: 2125mm



Mercedes Benz
3844201931

Tuberia rigida de compresor 4º tramo
MERCEDES BENZ 1721/1722 MOTOR OM924/924LA
EURO 5

MV 3718E

Largo: 2000mm



Mercedes Benz
3844201831

Tuberia rigida de compresor 5º tramo
MERCEDES BENZ 1721/1722 MOTOR OM924/924LA
EURO 5

MV 3718F

Largo: 2120mm



Mercedes Benz
3844201731

Tuberia rigida de compresor 7º tramo
MERCEDES BENZ 1721/1722 MOTOR OM924/924LA
EURO 5

MV 3718G

Largo: 1400mm



Mercedes Benz
3844201631

Tuberia rigida de compresor 8º tramo
MERCEDES BENZ 1721/1722 MOTOR OM924/924LA
EURO 5

MV 4201

500 mm.



Tuberia flexible de aire, salida de pistón de freno de motor
MERCEDES BENZ 1315 / 1618 - OM904

MV 4202



Mercedes Benz
6964208248
3844209848
9584200048

Tuberia flexible pulmón freno rueda delantera
MERCEDES BENZ ATEGO 1725 OM904

MV 4203**Mercedes Benz**
6884200048
6884208048
6964208248

Tubería flexible pulmón freno rueda delantera

MERCEDES BENZ O500 MOTOR OM904**MV 4204****Mercedes Benz**
6884207948
6884207648

Tubería flexible freno trasero

MERCEDES BENZ 712C-712-914 MOTOR OM904**MV 1651****Mercedes Benz**
0002955735
9582950535

Tubería flexible de embrague

MERCEDES BENZ AXOR MOTOR OM926**MV 1652****Mercedes Benz**
0002501266
9702951913

Tubería flexible de embrague

**MERCEDES BENZ 1752/1718/1720
MOTOR OM904/OM924****MV 1653****Mercedes Benz**
6882950535
6882950335
6882950235

Tubería flexible de embrague

MERCEDES BENZ 710/914/915 MOTOR OM904**MV 1654****Mercedes Benz**
3842950635
3842407017
6952950535

Tubería flexible de cilindro a receptor de embrague

MERCEDES BENZ OF1417/1418/1722 MOTOR OM904

REPUESTOS

nl M 19**Mercedes Benz**
1) 0000700533
2) 0000700633
3) 0000700733
4) 0000700833

Conjunto de 4 tuberías de inyección

MERCEDES BENZ SPRINTER 310/312/412

REPUESTOS

MV 1798**Mercedes Benz**
0000780481

Colector de rebase de inyectores

MERCEDES BENZ

REPUESTOS

MV 1773**Mercedes Benz**
0000960490

Lubricación de turbo

MERCEDES BENZ SPRINTER 410D**MV 1788B****Mercedes Benz**
0002380056
0002380156

Lubricación depresor con soporte

MERCEDES BENZ SPRINTER

REPUESTOS

MV 2208Mercedes Benz
0000960590

Lubricación de turbo

MERCEDES BENZ SPRINTER 312/312D

REPUESTOS

MV 2209Mercedes Benz
6904667181

Flexible de dirección hidráulica

MERCEDES BENZ SPRINTER 312/310**MV 0931**Mercedes Benz
9709970282

Tubería flexible de presión a la bomba de dirección hidráulica

MERCEDES BENZ 1752/1718/1723

REPUESTOS

MV 3165Mercedes Benz
6904207528

Caño de freno trasero derecho

MERCEDES BENZ SPRINTER**MV 3167**Mercedes Benz
6904207428

Rigido de freno hidráulico trasero izquierdo

MERCEDES BENZ

APLICACIÓN	DELANTERO	TRASERO
	CÓDIGO	CÓDIGO
170 - 220 - 300 - 300S - 1113 Brasil 1948/61	7511	7502
180 - 190 - 219 - 220A - 220S 1953/58 Der.	7503	7504
180 - 190 - 219 - 220A - 220S 1953/58 Izq.		750*
220S Der.	750€	7504
220S Izq.		7505
L-608-D	7507	7508
L-3500 / 4500 / 312	7509	7109
911 - 1112 - 1114	7509	7509
1112 - 1114 (Con Elásticos Suplementados)	7510	7510
1215 - 1415	7511	
0 - 140	7501	7512
g - 140 (Caño de Bomba Circuito Delantero)	7507	
1517	7513	7514
Unimog	7515	7716
913	7517	
180 Furgón	7515	7519
3500 - 312 - 1112	7120	
Sprinter	7521	7522
709 - 710 - 711	7523	7524
709 Modelo Nuevo	7525	

MV 2216

 Mercedes Benz
0002000052

Tubería de agua de calefacción

MERCEDES BENZ SPRINTER 310/312

REPUESTOS

EX 4



Exhibidor para 4 tuberías

VS

EX 5



Exhibidor para 5 tuberías

VS

EX 6



Exhibidor para 6 tuberías

VS