

LÍNEA ELECTRÓNICA COMMON RAIL

Catálogo de productos



- Repuestos de inyección diesel.
- Bombas de combustible.
- Filtros trampa de agua.
- Toberas elementos y válvulas.
- Inyectores.
- Sensores.
- Tensores.
- Mangueras de intercooler.
- Turbos Sobrealimentadores.
- Cajas y flexibles levanta cabina.
- Tuberías rígidas y flexibles.



Guia explicativa uso de catalogo productos CMD.

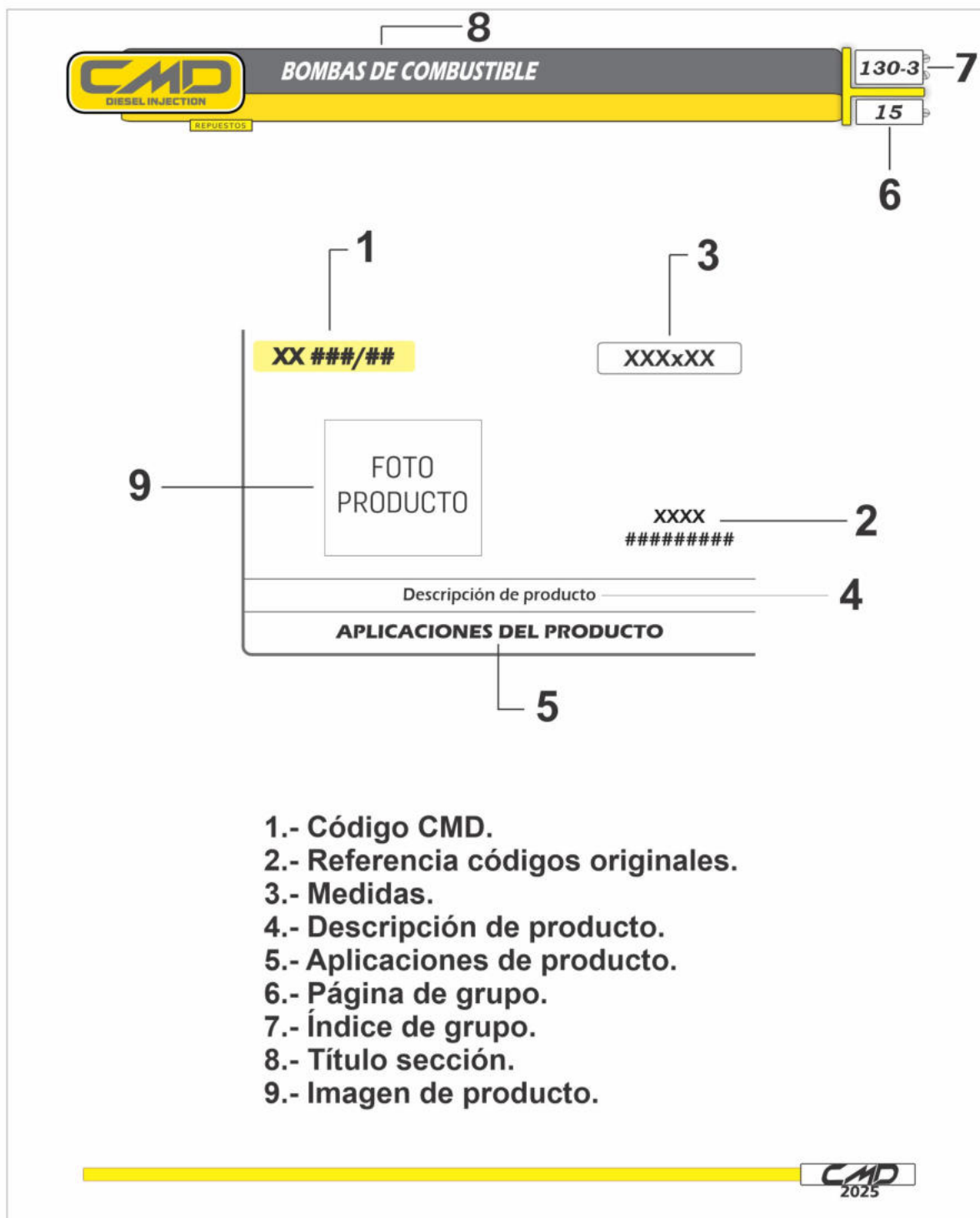

Las Marcas y Logos® que aparecen en los catalogos CMD pertenecen a sus respectivos dueños, y cuando son mencionadas estan a titulo informativo.

CUADRO EXPLICATIVO DE CODIFICACIÓN CATÁLOGO COMMON RAIL

O'RINGS VARIOS
XYZZ
01

REPUESTOS

XYZZ

→ CODIFICACIÓN

01

→ NÚMERO DE PÁGINA

X GRUPO	Y MARCA	ZZ PRODUCTO
1 COMMON RAIL	0 UNIVERSAL	00 UNIVERSAL
2 SISTEMA PDE	1 BOSCH	01 BOMBAS DE ALTA PRESIÓN COMPLETAS
3 SISTEMA PLD	2 DELPHI	02 KIT DE REPARACIÓN DE BOMBAS DE ALTA PRESIÓN
4 BOMBAS EDC	3 SIEMENS	03 VÁLVULAS REGULADORAS DE PRESIÓN / CAUDAL DE BOMBAS
6 HERRAMIENTAS	4 NIPON DENSO	04 ELEMENTOS
7 MAQUINARIAS		05 RETENES
		06 TAPAS DE BOMBAS
		07 BOMBAS DE BAJA PRESIÓN
		20 INYECTORES COMPLETOS
		21 KIT DE RAPARACIÓN DE INYECTORES
		22 TOBERAS
		23 PORTATOBERAS
		24 VÁSTAGOS DE INYECTOR
		25 VÁLVULAS PARA INYECTOR
		26 ARANDELAS DE CALIBRACIÓN DE INYECTOR
		27 RESORTES DE INYECTOR
		28 GRUPO MAGNÉTICO PARA INYECTORES
		40 RAMPAS
		41 VÁLVULAS REGULADORAS DE PRESIÓN DE RAMPAS
		42 VÁLVULAS SENSORAS DE PRESIÓN DE RAMPAS
		43 TUBERÍAS DE ALTA PRESIÓN
		44 VÁLVULAS LIMITADORAS DE PRESIÓN
		60 O'RINGS VARIOS
		61 ARANDELAS VARIAS
		62 RACORDS VARIOS
		63 BULONES Y TORNILLOS
		70 INYECTORES BOMBAS - PDE
		71 KIT DE REPARACIÓN DE INYECTORES BOMBA / PDE
		80 MONOBOMBAS - PLD
		81 KIT DE REPARACIÓN DE MONOBOMBAS / PLD
		90 PARA BOMBAS Y MONOBOMBAS
		91 PARA ARME Y DESARME DE INYECTORES
		92 PARA REPARACIÓN DE INYECTORES
		95 PARA CONTROL DE BOMBAS E INYECTORES COMMON RAIL
		96 PARA CONTROL DE SISTEMAS PLD Y PDE
		99 DESPIECES VARIOS

REPUESTOS
cm1001-001

Cummins Volkswagen
4088604 2T2130105A
4921431 Ford
4921434 BH1X9A543AA
4954200
4921434
3973228

Bomba de alta presión original

CUMMINS ISLe ISCe CCR1600
cm1003-001

Cummins
4903523

Válvula Reguladora de Caudal de Bomba Original

**CONSTELLATION EURO V 19, 330T 19/25/26, 390T
FORD ISLe - CUMMINS QSC 8.3**
cm1004-001

Cummins
4902732

Elemento de cerámica con camisa original Cummins para bomba de alta presión ISLe ISCe

**CUMMINS QSC 8.3 - VOLKSWAGEN CONSTELLATION EURO
V 19-330T 19/25/26-390T ISLe - FORD CARGO 1832 ISLe**
cm1007-001

Cummins
4088866
Volkswagen
2t2198119A
Ford
BH0X9C545AA

Bomba de engranaje original

**VOLKSWAGEN CONSTELLATION V 19-330T-19/25/26 - 390T ISLe
FORD ISLe - CUMMINS QSC 8.3**
cm1099-001

Cummins
4921732

Botador de bomba original

**VOLKSWAGEN CONSTELLATION V 19-330T-19/25/26 - 390T ISLe
FORD ISLe - CUMMINS QSC 8.3**
cm1099-002

Cummins **Komatsu**
5260634 1317797H91
3968190
3970198
3968189
4947999

Bomba de transferencia original

**VOLKSWAGEN CONSTELLATION V 19-330T-19/25/26 - 390T ISLe
FORD ISLe - CUMMINS QSC 8.3**
cm1099-003

Cummins
4954199

Cabezal para bomba de alta presión ISLe ISCe

**VOLKSWAGEN CONSTELLATION EURO V 19-330T 19/25/26-390T ISLe -
FORD CARGO 1832 ISLe - CUMMINS QSC 8.3**
cm1099-004

Cummins
3330991

Eje de levas para bomba de alta presión ISLe ISCe

**CUMMINS QSC 8.3 - VOLKSWAGEN CONSTELLATION EURO
V 19-330T 19/25/26-390T ISLe - FORD CARGO 1832 ISLe**
cm1099-005

Cód Original
1213195

Juego de juntas para bomba de alta presión ISLe ISCe

**CUMMINS QSC 8.3 - VOLKSWAGEN CONSTELLATION EURO
V 19-330T 19/25/26-390T ISLe - FORD CARGO 1832 ISLe**
cm1099-007

Cummins
3969822

Conector desconexión rápida de bomba de alta presión ISLe ISCe

**CUMMINS QSC 8.3 - VOLKSWAGEN CONSTELLATION EURO
V 19-330T 19/25/26-390T ISLe - FORD CARGO 1832 ISLe**
REPUESTOS
cm1102-001

20 x 32 x 7



Bosch
F00R0P0890
F00N202338

Kit de juntas y retenes

OIL SEAL PUMP BH C/R = F00R0P0890 = F00N202338
COMMON RAIL - BOSCH
cm1102-002

25 x 37 x 7



Bosch
F00R0P0669
F00N202337

Kit de o-rings y retenes

OIL SEAL PUMP BH C/R-CP3/CP4 = F00R0P0669 = F00N202337
COMMON RAIL CP3/CP4 - BOSCH
cm1102-003

Kit de O-rings con retenes y bolillas

COMMON RAIL - BOSCH

REPUESTOS

cm1102-004 20 x 31 x 7

Juego de juntas con retén vitón
COMMON RAIL - BOSCH

cm1102-005 20 x 31 x 7

Juego de juntas con dos retenes vitón y O'ring
IVECO DAILY

cm1102-006

Juego de juntas con retenes
IVECO - MERCEDES BENZ - KIA

cm1102-007

Juego de juntas para Cp1
BOSCH

cm1102-008

Juego de juntas
Bosch F01M100278
BOSCH

cm1102-009

Juego de juntas para bomba Cp1. Con 3 O'rings conformados
Bosch F01M101454 Ex - F01M1002175
BOSCH

cm1102-010

Juego de juntas
Bosch F01M100276
BOSCH

cm1102-011

Juego de juntas
Bosch F00N201973
BOSCH

cm1102-012

Juego de juntas
Bosch F00N201977
BOSCH

cm1102-013

Juego de juntas CP1
Bosch F01M100277
BOSCH

cm1102-014

Juego de juntas para bomba CP1H3 - Con filtro
CHEVROLET S10/BLAZER - NISSAN FRONTIER 2.8 - 4,07TCE

cm1102-015 Teflón 11mm

Juego de juntas para bomba
FIAT - RENAULT - PEUGEOT - NISSAN

cm1102-016

Juego de juntas bomba
VOLKSWAGEN AMAROK CP4

+F01M100275

Juego de juntas
Bosch F01M100275
BOSCH CP1

+F01M100277

Juego de juntas
Bosch F01M100277
BOSCH CP1

REPUESTOS

cm1103-010



Bosch
1465ZS0010
0928400672

Válvula dosificadora de caudal bomba CR

FORD 350 4000 CUMMINS ISF 2.8 - OPEL 2.5
NISSAN 110/115/120/150 DCI - RENAULT MASTER
120 DCI MOTOR G9U 630/632/650

cm1103-014



Bosch
1465ZS0014
0928400703
0928400750
0928400769

Válvula dosificadora de caudal bomba CR

RENAULT MASTER III 2.3 DCI M9T

cm1103-015



Bosch
1465ZS0015
0928400709

Válvula dosificadora de caudal bomba CR

MAHINDRA PICK UP/SCORPIO/XUV500 2.2

cm1103-018



Bosch 0445010182
1465ZS0018 0445010198
0928400726 0445010219
0928400728 0445020046
0928400802 0445020123
0445110291 0445110291

Válvula dosificadora de caudal bomba CR

FORD CARGO 1717/2422/2622/815EB ISUZU MOTOR 4JB1
IVECO DAILY - DUCATO 2.3 MULTIJET

cm1103-019



Bosch
1465ZS0019
0928400794

Válvula dosificadora de caudal bomba CR

MWM

cm1103-029



Bosch
1465ZS0029
0928400848
MWM
7006536R1

Válvula dosificadora de caudal bomba CR

NISSAN FRONTIER 2.8 MWM

cm1103-031



Bosch
1465ZS0031
0928400830
0928400831

Válvula dosificadora de caudal bomba CR

CHEVROLET S10 TRAILBLAZER 2.8

cm1103-033



Bosch
1465ZS0033
0928400826
Fiat
71772310

Válvula dosificadora de caudal bomba CR

**CITROËN JUMPER 2.3 HDI - FIAT DUCATO 2.3JTD
IVECO DAILY - PEUGEOT BOXER 2.3 HDI**

cm1103-040



Bosch
1465ZS0040
0928400481
0928400638
Cummins
4088518
4937597

DAF
1638153
Iveco
42541851
4937597

Válvula dosificadora de caudal bomba CR

**AGRALE - CASE - CUMMINS ISBE6/E4 - FORD F100/F250/CARGO
IVECO TECTOR/EUROCARGO - MWM 2.8
VOLKSWAGEN CONSTELLATION/WORKER**

cm1103-054



Bosch
1465ZS0054
0928400642
Cummins
4936097

Válvula dosificadora de caudal bomba CR

**DODGE RAM 2500/3500/4500 (2008/2010)
6.7 ISB CUMMINS**

cm1103-056



Bosch 1465ZS0056
0928400644
0928400712
1465ZS0081

Cummins 5257595
DAF 1784517

Válvula dosificadora de caudal bomba CR

**CUMMINS ISF 3.8 ISBE/3.9/5.9 ISDE QSB
FORD F100/F250/CARGO**

cm1103-057



Bosch
1465ZS0057
0928400646

Válvula dosificadora de caudal bomba CR

MERCEDES BENZ - MITSUBISHI CANTER 4.9

cm1103-062



Bosch
1465ZS0062
0928400562
0928400666
092840084
Cummins
4932457

Válvula dosificadora de caudal bomba CR

DODGE RAM 2500/3500 - CUMMINS 5.9/6.7 ISB

cm1103-064



Bosch
1465ZS0064
0928400674
Renault
8201011874

Válvula dosificadora de caudal bomba CR

TOYOTA YARIS 1.4 D-4D

cm1103-069



Bosch
1465ZS0069
0928400607
0928400633
0928400682

Válvula dosificadora de caudal bomba CR

HYUNDAI H1 2.5 CRDI - KIA SORENTO 2.5 CRDI

cm1103-081



Bosch
1465ZS0081
0928400638
0928400712
Cummins 42541851
5257595 4937597
DAF
1784517

Válvula dosificadora de caudal bomba CR

**AGRALE - CUMMINS ISB 3.8/ISBE 3.9/5.9 ISDE QSB
FORD F100/F250/CARGO - IVECO TECTOR/EUROCARGO
MWM 2.8 - CONSTELLATION**

cm1103-082



Bosch
1465ZS0082
0928400608
0928400713

Válvula dosificadora de caudal bomba CR

HYUNDAI H1 2.5 CRDI - KIA SORENTO 2.5 CRDI

cm1103-083



Bosch
1465ZS0083
0928400675
0928400714
Renault
7701068143
Suzuki
15610-67JG1-000

Válvula dosificadora de caudal bomba CR

**RENAULT SCENIC/MEGANE/LAGUNA 1.9 DCI
SUZUKI GRAND VITARA 1.9 DCI**

REPUESTOS

cm1103-087



Bosch
1465ZS0087
02928400665
0928400719
Mercedes Benz
A6420740284

Válvula dosificadora de caudal de bomba CR

MERCEDES BENZ SPRINTER/VIANO/VITO 3.0

cm1103-091



Bosch
1465ZS0091
0928400614
09284400736

Válvula dosificadora de caudal de bomba CR

CHEVROLET S10 2.9 MWM

cm1103-103



Bosch
1465ZS0103
0928400761
Man
51125050041
51154200003
Volkswagen
07W1307658

Válvula dosificadora de caudal de bomba CR

MAN TGL 4.6L/6.9L D0836/D0834 - VOLKSWAGEN 15190 17230/17260/17280/CONSTELLATION/WORKER

cm1103-110



Bosch
1465ZS0110
0928400789

Válvula dosificadora de caudal de bomba CR

AGRALE 8500/9200/MA75/MA85/MA 9 MOTOR MWM VOLKSWAGEN 15180/15190/17210/17230/17260/8150EOD 9150EOD/CONSTELLATION - VOLVO VM210/VM260/VM310

cm1103-130



Bosch
1465ZS0130
0928400617
0928400627

Válvula dosificadora de caudal de bomba CR

CITROËN BERLINGO/PICASSO 1.6 HDI - CUMMINS ISBE ISDE ISF FORD CARGO 1933 - MAN TGA/TGL/TGM/TGS/TGX VOLKSWAGEN CONSTELLATION

cm1103-473



Bosch
0928400473
Cummins
4088518

Válvula reguladora de presión/unidad de medición

VOLKSWAGEN CONSTELLATION FORD CARGO - CUMMINS 8.3L

cm1103-481



Bosch
0928400481
0928400638
Iveco
42541851
Cummins
4937597

Válvula reguladora de presión / unidad de medición

IVECO / NEW HOLLAND 3.9 - 4.5 - 6.7

cm1103-487



Bosch
0928400487
1465ZS0041
Renault
8200179757

Válvula reguladora de presión/unidad de medición

RENAULT MASTER 2.5 G9U

cm1103-606



Bosch
0928400606

Válvula reguladora de presión/unidad de medición

TOYOTA YARIS/ETIOS 1ND-TV (1.4 D-4D)

cm1103-607



Bosch
0928400607

Válvula reguladora de presión/unidad de medición

FORD FOCUS - CITROËN C3/BERLINGO PEUGEOT PARTNER - 1.6 TDCI Y HDI

cm1103-612



Bosch
0928400612
Mercedes Benz
A6400740084

Válvula reguladora de presión/unidad de medición

MERCEDES BENZ A160/A180/A200 2.0 CDI

cm1103-633



Bosch
0928400633
0928400682

Válvula reguladora de presión/unidad de medición

HYUNDAI H1 - KIA SORENTO 2.5 CRDI

cm1103-644



Bosch
0928400644

Válvula reguladora de presión/unidad de medición

FORD F100 - CUMMINS 3.9

cm1103-653



Bosch
0928400653
0928400574
Silverado
8973698501

Válvula reguladora de presión/unidad de medición

CHEVROLET SILVERADO NISSAN FRONTIER

cm1103-661



Bosch
0928400661
0928400677
Mercedes Benz
A6420740184

Válvula reguladora de presión/unidad de medición

MERCEDES BENZ SPRINTER 418 - OM642 3.0 CRD JEEP GRAND CHEROKEE - 3.0 CRD

cm1103-666



Bosch
0928400666
4932457

Válvula reguladora de presión/unidad de medición

DODGE RAM 2500/3500 CUMMINS 5.9

cm1103-672



Bosch
0928400672

Válvula reguladora de presión/unidad de medición

FORD PESADOS F350/F400 CUMMINS ISF 2.8

cm1103-706



Bosch
0928400706
1462C00987

Válvula reguladora de presión/unidad de medición

VOLKSWAGEN AMAROK - 2.0

REPUESTOS

cm1103-711



Bosch
0928400711
Cummins
4992596

Válvula reguladora de presión/unidad de medición

DODGE RAM 3500 - 6.7

cm1103-712



Bosch
0928400712
1465ZS0081
Cummins
5257595

Válvula reguladora de presión/unidad de medición

FORD CARGO C1317/C1517/C1722
VOLKSWAGEN 8.150E/9.150E MOTOR CUMMINS 5.9

cm1103-713



Bosch
0928400713

Válvula reguladora de presión / unidad de medición

HYUNDAI STAREX/H100/H1
KIA CERATO/SORENTO - 2.5 CRDI

cm1103-714



Bosch
0928400714
0928400675
Renault
7701068143

Válvula reguladora de presión / unidad de medición

RENAULT MEGANE II/LAGUNA II/SCENIC II
F9Q 1.9 DCI

cm1103-726



Bosch
0928400726
Fiat
71754810
42578530

Válvula reguladora de presión / unidad de medición bomba

FIAT DUCATO MULTIJET
IVECO DAILY 29L10 - 2.3 JTD

cm1103-728



Bosch
0928400726
0928400728
Fiat
71754810

Válvula reguladora de presión / unidad de medición bomba

FIAT DOBLO MULTIJET 1.6 / 2.0 FIAT DAILY / DUCATO 2.3
CITROEN JUMPER 2.3 / PEUGEOT BOXER - 2.3

cm1103-736



Bosch
0928400736
0928400614

Válvula reguladora de presión/unidad de medición

CHEVROLET
S10 BLAZER 2.8 - 4.0TCE

cm1103-739



Bosch
0928400739
Iveco
42560782

Válvula reguladora de presión/unidad de medición

FIAT DUCATO MULTIJET
IVECO DAILY 35C14 / 40C15 / 50C18 / 70C18 - 3.0

cm1103-759



Bosch
0928400759
0928400771
0928400766
Doosan
800215-00004

Válvula reguladora de presión / unidad de medición bomba

FORD - 4.4/6.7

cm1103-761



Bosch
0928400761
Man
51154200003
51125050041

Válvula reguladora de presión / unidad de medición bomba

MAN - 4.6/6.9

cm1103-788



Bosch
0928400788
1462C00997

Válvula reguladora de presión / unidad de medición bomba

PEUGEOT PARTNER/207/308
1.6 HDI 8V

cm1103-789



Bosch
0928400789

Válvula reguladora de presión / unidad de medición bomba

DEUTZ MWM - VOLVO VM 210/260/310 - AGRALE MWM
VOLKSWAGEN WORKER/CONSTELLATION/13180/15180/26260
31260/8150/9150/17210 - 4.12 TCE - MWM 4.12/6.12 TCE

cm1103-826



Bosch
0928400826
Fiat
71772310

Válvula reguladora de presión / unidad de medición bomba

FIAT DUCATO MULTIJET - 2.3

cm1103-830



Bosch
0928400830

Válvula reguladora de presión / unidad de medición bomba

CHEVROLET S10 - 2.8 CTDI

cm1103-983



Bosch
1462C00983
0928400752
0928400800

Válvula dosificadora de caudal de bomba CR

HYUNDAI SANTA FE 2.0/2.2 CRDI
KIA CARNIVAL/SORENTO/SPORTAGE 2.0/2.2 CRD

cm1103-985



Bosch
1462C00985
0928400708
0928400748

Válvula dosificadora de caudal bomba CR

AUDI A4/A5/A6/Q5/Q7 2.7/3.0 TDI
VOLKSWAGEN PHAETON/TOUAREG 3.0 V6 TDI

cm1103-991



Bosch
1462C00991
0928400691
0928400781
BMW
13517797875

Válvula dosificadora de caudal bomba CR

BMW E90/E91/X3 E83/E92/E81/E93/E88 MOTOR 316D/320D/318D
320D XDRIVE/XDRIVE 18D/XDRIVE 20D/2.0SD/118D/116D/120D

cm1103-992



Bosch
1462C00992
0928400821
Cummins
5298424
837079633
Fendt
V837079633

Válvula dosificadora de caudal bomba CR

ALFA ROMEO STELVIO/GIULIA 2.2
AUDI A4/A5/A6/Q5/Q7

REPUESTOS

cm1103-997



Bosch
1462C00997
Ford
1810413
Peugeot
9806448980

Válvula reguladora de presión / unidad de medición bomba

CITROËN BERLINGO/C3/C4
PEUGEOT 206/207/208/308 PARTNER - 1.4HDI
FORD FIESTA/FOCUS/MONDEO 1.4/1.5/1.6 - TDCI

cm1103-998



Bosch
1462C00998
0928400757
Fiat
F00N210191

Válvula dosificadora de caudal de bomba CR

FIAT DUCATO 3.0 MULTIJET
IVECO DAILY 2.3/3.0 EURO 5

REPUESTOS

cm1120-002



Bosch Renault
0445120002 5001849912
0986435501 Fiat
Peugeot 500313105
198081
198083
Iveco
500384284
500313105

Inyector Common Rail

IVECO DAILY - FIAT DUCATO
CITROËN JUMPER - PEUGEOT BOXER 2.8

cm1120-007



Bosch Iveco
0445120007 2830957
Ford 2830224
B69X9K526BA 2830221
Volkswagen
Zr0198133
Cummins
5255184
5263307

Inyector Common Rail

FORD CARGO 2828E/815E /F100 - VOLKSWAGEN WORKER
CONSTELLATION - AGRALE MT12.0
IVECO EUROARGO/TECTOR CUMMINS 3.9/5.9

cm1120-140



Bosch
0445120140
Cummins
4945316
Volkswagen
2T2198133

Inyector Common Rail

VOLKSWAGEN CONSTELLATION 19320/18320
25320/31320 CUMMINS 8.3

cm1120-189



Bosch
0445110107
0445110108
0445110189
0445110190
Mercedes Benz
A6110701687
A6110701487
Jeep
5080300AA

Inyector Common Rail

MERCEDES BENZ SPRINTER 208/211/311/308/313/312/316
411/413/OM611/OM611LA - JEEP GRAND CHEROKEE II 2.7

cm1120-212



Bosch
0445120212
0986435508
Cummins
5263307

Inyector completo

FORD CARGO 1722/1517/1317/915/ F100 - IVECO 170E22
VOLKSWAGEN 13.170/15.170/8.150/CONSTELLATION
CONSTELLATION 8.150/9.150 CUMMINS 3.9 / 5.9

cm1120-236



Bosch
0445120236
0445120125
Cummins
4940170
Case
5263308

Inyector completo

FORD CARGO 1832 CUMMINS

cm1120-326



Bosch
0445120326
0445120043
MWM
961204640014
Volkswagen
2R0130201B

Inyector completo

AGRALE BUS MWM 4.8

cm1120-629



Bosch
0445110538
0445110539
0445110629
0445110628
Isuzu
1112100ABYB1
JMC
CN1-9K546-A1A

Inyector Common Rail

ISUZU JMC MOTOR 2.8 4JB1 EURO 4

cm1120-646



Bosch
0445110646
0445110369
Volkswagen
03L130277J
03L1302770

Inyector Common Rail

VOLKSWAGEN AMAROK/VENTO 2.0 TDI
CNFA/CNFB/CNEA/CNEA

REPUESTOS

cm1121-001



Bosch
9600161

Kit para inyector (Bolita/O'ring junta)

COMMON RAIL

cm1121-002



Bosch
F00VC99002

Kit arandelas

BOSCH - COMMON RAIL

REPUESTOS

cm1122-047



Tobera Common Rail

COMMON RAIL DLLA142P1709

cm1122-135



Tobera Common Rail Bosch - DLLA145P2135

CHEVROLET S10 2,8 CTDI

Inyectoros CR
0445110354
0445110424

Bosch
0433172135
0433172252

cm1122-137



Tobera Common Rail Bosch - DLLA152P2137

PEUGEOT PARTNER / BERLINGO 1,6 HDI 8 VAL

Inyectoros
0445110739
0445110340

Bosch
0433172137
DLLA152P2137

cm1122-160



Tobera Common Rail - DLLA162P2160

**VOLKSWAGEN AMAROK/TIGUAN/VENTO
AUDI A1 A3 A4 A5 A6/AUDI Q3 Q5 TT 2,0TDI**

Inyectoros
0445110368 0986435166
0445110369 0445110429
0445110646 0311130277J
0445110647 031130277Q

Bosch
0433172160

cm1122-163



Tobera DSLA156P736

**MERCEDES BENZ C200 CDI
C220/C270/CLK270/E200/E220**

Bosch
0433175163

cm1122-196



Tobera Common Rail DSLA142P795

**PEUGEOT 206/306/307/406/PARTNER 2.0 HDI -
CHEVROLET TRAKKER 2.0 HDI
CITROEN BERLINGO/XSARA/PICASSO 2.0 HDI - FIAT DUCATO 2.0 HDI**

Inyectoros
0445110008

Bosch
0433175196

cm1122-203



Tobera Common Rail DSLA136P804

IVECO DAILY 29-35-40

Bosch
0433175203

cm1122-203A



Tobera Common Rail - DLLA118P2203

**FORD CARGO 1832 - CASE CNH 2799/2399
8,3 LTS CUMMINS**

Bosch
0433172203

cm1122-271



Tobera Common Rail DSLA143P970

**FORD CARGO C1317 ISBe4 3.9/CARGO C1722 ISBe 5.9
VOLKSWAGEN 8150E ISBe4 3.9/CONSTELLATION 17250 ISBe4 5.9
IVECO EUROARGO 3.9/5.9 - CUMMINS ISBe4**

Inyectoros
0445120007

Bosch
0433175271

cm1122-281



Tobera common rail - DLLA140P2281

JAC SUNRAY 2.8

Inyectoros
0445110465 0445110717
0445110466 0445110718
0445110794

Bosch
0433172281

cm1122-302



Tobera Common Rail - 154P2302

RENAULT CLIO/KANGOO/LOGAN 1,5 DCI

Inyectoros
0445110485 1660000Q1L
0986435240
166008399R

Bosch
0433172302

cm1122-395



Tobera Common Rail - DSLA154P1320

**MERCEDES BENZ SPRINTER 211/311/313/411/413
OM611 2.2 CDI - JEEP GRAND CHEROKEE**

Inyectoros
0445110189
0445110107

Bosch
0433175395

cm1122-431



Tobera Common Rail - DSLA142P1474

**PEUGEOT 206/306/307 - SUZUKI GRAND VITARA
CITROEN PICASSO C4 2,0 HDI**

Inyectoros
0445110062 0986435077
04451102276
04451102404

Bosch
0433175431

cm1122-449



Tobera Common rail - DSLA128P1510

**KOMATSU PC200-8/SAA6D107E-1 QSB6,7
TIER 3/TIER 4/STAGE 4,5 6,7LTS - HYUNDAI HL770-7A QSL8,9**

Inyectoros
0445120059
0445120231

Bosch
0433175449

cm1122-501



Tobera Common Rail DSLA143P5501

**FORD CARGO C1317 ISBe4 3.9/CARGO C1722 ISBe 5.9
VOLKSWAGEN 8150E ISBe4 3.9/CONSTELLATION 17250 ISBe4 5.9
IVECO EUROARGO 3.9/5.9 - CUMMINS ISBe4**

Inyectoros
0445120212

Bosch
0433175501

cm1122-510



Tobera Common rail - DSLA128P5510

**CUMMINS SAA6D107 E-1 - KOMATSU PC 200-8
QSB6,7**

Inyectoros
0445120231
0986435597

Bosch
0433175510
Lucas/Delphi
LDFN 0459

cm1122-517



Tobera Common Rail- DSLA143P5517

CUMMINS 6,7 ISD

Inyectoros
0445120060 4983267
3977080 5263321
3977081

Bosch
0433175517

cm1122-519



Tobera Common Rail - DSLA143P5519

DODGE RAM 5.9L CUMMINS

Inyectoros
0445120018
0445120113
0445120210
0445120255

Bosch
0433175519

REPUESTOS

cm1122-576

Injectores
0414701008 0414701057
04147010019 0414701067
0414701045

Bosch
0433171576
Scania
1412401

Tobera Common rail - DLLA150P848

SCANIA 114 340-381 1995 MOTOR 10,6D DC11,03 DC11,04
124 360-420 1995 MOTOR 12,0D DC12,02 K IB BUS EURO 3 P360 T400 T420
164 480 2000-2004 MOTOR DC16,01 DC16,02 R480 T480 EUROS

cm1122-693

Injectores
0445110081

Bosch
0433171693

Tobera Common Rail DLLA148P1067

CHEVROLET BLAZER/S10 2.8E 4.07TCE
NISSAN FRONTIER/XTERRA 2.8E 4.07TCE

cm1122-699

Injectores
0445120019
0445120020
0445120084

Bosch
0433171699
Renault
5600680090

Tobera Common Rail DLLA150P1076

RENAULT PREMIUM 370/420 - IVECO

cm1122-712

Injectores
0445110095
045110096
0445110120
0445110121/201/202
0986435037/051/063

Bosch **Lucas/Delphi**
0433171712 LDFN0341
Mercedes Benz
6130780423
A6130780423

Tobera Common Rail - DLLA156P1107

MERCEDES BENZ SPRINTER 311 CDI 2.1/2.2

cm1122-755

Injector
0445110290
0445110126
0445110729

Bosch
0433171755

Tobera Common rail - DLLA150P1197

HYUNDAI TUCSON STA.FE 2.0 - KIA STORAGE 2.0

cm1122-811

Injectores
0445110141

Bosch
0433171811

Tobera Common Rail DLLA 146P1296

RENAULT MASTER 2.3/2.5

cm1122-846

Injectores
0445110187 71794088
0986435099 551922.579
55191959 55221018
71793237

Bosch
04333171846

Tobera Common rail - DLLA142P1363

FIAT DOBLO / LINEA 1.9 D

cm1122-848

Injector
0445110186
0445110279
0445110730

Lucas/Delphi **Bosch**
LDFN0345 0433171848
Zexel F01G00100F
105017-7420

Tobera Common rail - DLLA156P1368

HYUNDAI STARDEX H-1 2.5 CRDI

cm1122-853

Injector
1326820
0445110188

Bosch
0433171853

Tobera Common Rail - DLLA150P1373

PEUGEOT 206/306/307/407 - CITROEN C4/C5/XSARA
FORD FOCUS 1.6 HDI

cm1122-870

Injectores
0445110141

Bosch
0433171870

Tobera Common rail - DLLA143P1404

AGRALE 8500 - DEUTZ 9200 7.5/8.5/7.2 E-TRONIC
VOLKSWAGEN CONSTELLATION 31.26 CE

cm1122-889

Injector
044510183
0445110316
0445110331

Bosch **Ford** **Chevrolet**
0433171889 9s51 93183910
Fiat 55197875 9f593 BA 93190435
55197124 1538758 **Suzuki**
71794966 15710 86J20 000

Tobera Common Rail - DLLA150P1437

ALFA ROMEO MITO 1.3 JTD - FIAT 500/DOBLO/FIORINO/PUNTO/IDEA
QUBO 1.3 MULTIJET STRADA 1.3 JDCI - FORD KA 1.3 TDCI
CHEVROLET AGILE/ASTRA/CORSA/MERIVA 1.3 CTDI - SUZUKI SPLASH SWIFT 1.3 DDIS

cm1122-914

Injector
0445110239
0445110311

Bosch
0433171914

Tobera Common Rail DLLA149P1471

CITROEN BERLINGO/C3/C4 - PEUGEOT 207/307/PARTNER
SUZUKI SX4 - FORD FIESTA/FOCUS 1.6 HDI

cm1122-932

Injector
0445110725
0445110246
0445110257
0445110258

Bosch
0433171932
Hyundai
3380027400

Tobera Common Rail - DLLA150P1511

KIA MAGENTIS - HYUNDAI SONATA/TUCSON 2.0 CRDI

cm1122-933

Injector
0445110253
0445110254
0445110726

Bosch
0433171933

Tobera Common Rail - DLLA150P1512

HYUNDAI GRANDEUR/SANTA FE 2.2 D

cm1122-945

Injectores
0445110248

Bosch
0433171945

Tobera Common Rail - DLLA138P1533

FIAT DUCATO - IVECO DAILY 35/40/45/50 3.0

cm1122-947

Injector
044520054
2855491
504091504

Bosch
0433171947
Seven
71905516

Tobera common rail - DLLA143P1536

IVECO EURO CARGO 3.9 D

cm1122-964

Injectores
0445120066
0986435548

Bosch **Volvo**
0433171964 7422017818
Renault
7422017818

Tobera common rail - DLLA144P1565

VOLVO G900 D7D DEUTZ / G900 /
EXCAVADORA EC240 B/C D6D DEUTZ

cm1122-965

Injectores
0445120074 0986435535
0445120138 0986435536
0445120139

Bosch **Volvo**
0433171965 7422018493
Renault
5600735882

Tobera common rail - DLLA150P1566

RENAULT MIDIOULM 4.8 EURO 3
MIDIOULM 4.8 EURO 4 VOLVO FE 7.1 EURO 3

REPUESTOS

cm1122-966



Inyector
0445120638
0445120075

Bosch
0433171966

Tobera common rail - DLLA137P1577

NEW HOLLAND T7040 6.7 147KW / T7060 6.7 164KW
W190B 6.7 169KW

cm1122-980



Inyector
0445110269
0445110270
0986435153

Bosch
0433171980

Tobera common rail - DLLA150P1606

CHEVROLET CAPTIVA 2.0 CDRI / CRUZE 2.0 CDI
OPEL ANTARA 2.0 CDTI

cm1122-982



Inyector
0445110274
0445110275
0445110724

Bosch
0433171982

Tobera common rail - DLLA153P1608

HYUNDAI H100 / KIA SORENTO - D4CB 2.5

cm1122-983



Inyector
0445110277
0445110278
0986435181

Bosch
0433171983

Tobera common rail - DLLA153P1609

HYUNDAI H100 / H-1/STAREX 2.5 CDRI

REPUESTOS

cm1125-C05



Inyector
0445110021
0445110146

Bosch
F00VC01005

Válvula de tercera etapa Bosch

RENAULT LAGUNA 1.9 DCI / MEGANE 1.9 DCI
SCENIC 1.9 DCI

cm1125-005A



Bosch
F00GX17005

Válvula de tercera etapa

VOLKSWAGEN AUDI 2,0TDI/3,0TDI
GOLF/SCIROCCO/TIGUAN/PASSAT/SKODA 2,0TDI

cm1125-003



Inyector
0445110008 0445110062
0445110020
0445110044

Bosch
F00VC01003

Válvula de tercera etapa Bosch

PEUGEOT 206/306/307/406/PARTNER 2.0 HD
CITROEN BERLINGO/XSARA/PICASSO 2.0 HD
SUZUKI G.VITARA 2.0 HD - FIAT DUCATO 2.0 HD

cm1125-005



Inyector
0445120002

Bosch
F00RJ00005

Válvula de tercera etapa Bosch

FIAT DUCATO 2.8 - IVECO DAILY 2.8
PEUGEOT BOXER 2.8 HDI

cm1125-022



Inyector
0445110084 0445110141
0445110087
0445110102

Válvula de tercera etapa Bosch

RENAULT MASTER 2.5 / LAGUNA II 2.2 DCI

cm1125-023



Inyector
0445110076 0445110231
0445110081 0445110336
0445110125 0445110337

Bosch
F00VC01023

Válvula de tercera etapa Bosch

CHEVROLET BLAZER/S10 2.8E - 4.07TCE
NISSAN FRONTIER/XTERRA 2.8E - 4.07TCE

cm1125-033



Inyector
0445110091 0445110279
0445110092 0445110283
0445110185 0445110306
0445110186

Bosch
F00VC01033

Válvula de tercera etapa

HYUNDAI H11 2.5 - KIA SORENTO 2.5

cm1125-034



Inyector
0445110109
0445110110
0445110127
0445110144

Bosch
F00VC01034

Válvula de tercera etapa Bosch

RENAULT MEGANE II / LAGUNA 1.9 DCI

cm1125-038



Inyector
0445110686
0445110083
0445110687

Bosch F00VC01038
Alfa Romeo 0000046472233
95400103

Fiat 464302102
46462971
46472233
95400103

Lancia 95400103

Válvula de tercera etapa Bosch

ALFA ROMEO 145 2.0 - FIAT WEEKEND 1.6

REPUESTOS

cm1125-044

Inyector
0445110064
0445110101
0445110126
0445110290

Bosch
F00VC01044

Válvula de tercera etapa Bosch

HYUNDAI ACCENT 1.5/SANTA FE 2.0
KIA SPORTAGE 2.0

cm1125-051

Inyector
0445110181 0445110207
0445110189 0445110224
0445110200
0445110205

Bosch
F00VC01051

Válvula de tercera etapa

MERCEDES BENZ SPRINTER 211/311/313/411/413
MERCEDES BENZ 108/110/VITO - OM611 2.2 CDI

cm1125-053

Inyector
0445110076

Bosch
F00VC01053

Válvula de tercera etapa Bosch

CITROEN BERLINGO/XSARA/PICASSO 2.0 HDI - PEUGEOT 206/306
307/406/PARTNER 2.0 HDI - FIAT DUCATO 2.0 HDI

cm1125-064

Inyector
0445120326
0445120330

Bosch
F00RJ03064

Válvula de tercera etapa Bosch

VOLKSWAGEN 3207/3208 CONSTELLATION 4.7
3610/3611 CONSTELLATION 7.1

cm1125-067

Inyector
0445120043
0445120077
0445120077
0445120089

Bosch
F00RJ02067
Lucas/Delphi
LDFH0056

Válvula de tercera etapa Bosch

VOLKSWAGEN 13170/13180/14180 CANYON MOTOR 7.1 12V MWM 6.12 TCE
15110 MOTOR 4.8 8V MWM 4.12 TCE / 17250 BUS MOTOR 7.3 12V MWM MAXXP ACTEON 4.12 TCE
8150 CANYON MOTOR 3.0 8V MWM 4.08 TCE / CONSTELLATION TRUCK 13180 MOTOR 6.8 8V MWM 6.12 TCE
VOLVO 240 RIGIDO 7.2L 12V SOHV L6 V 4A

cm1125-130

Inyector
0445120059 0445120208
0445120060 0445120209
0445120123 04451200210
0445120151 0445120211
0445120152 0445120212

Bosch
F00RJ02130

Válvula de tercera etapa

FORD CARGO C1317E/1517E/F250 4BTAA
VOLKSWAGEN 8150E/CONSTELLATION 17250 ISBe4 - ISBe6
IVECO EURO CARGO 3.9 - 5.9

cm1125-204

Bosch
F00VC45204

Válvula de tercera etapa

PEUGEOT BOXER 2,3HDI - CITROËN JUMPER 2,3HDI
FIAT DUCATO 2,3JTD - IVECO DAILY 3,0

cm1125-206

Inyector
0445110418
0445110520
0445110682

Bosch
F00VC45206

Válvula de tercera etapa Bosch

FIAT TORO 1.8 / DUCATO 2.3
IVECO DAILY 2.3 / 3.0

cm1125-278

Inyector
0445120075
004512054
0445120057

Bosch
F00RJ01278
Lucas/Delphi
LDFH0026

Válvula de tercera etapa Bosch

CASE MX200 8.3 - IVECO EURO CARGO 6.7
FIAT NEW HOLLAND 3.9

cm1125-306

Inyector
0445110096 0445110154
0445110142 0445110214
0445110143 0445110215
0445110153

Bosch
F00VC01306

Válvula de tercera etapa Bosch

MERCEDES BENZ ML270 E320 CDI
TOYOTA YARIS 1.4D

cm1125-315

Inyector
0445110239

Bosch
F00VC01315
Lucas/Delphi
LDFH0134

Válvula de tercera etapa Bosch

PEUGEOT 307/PARTNER/EXPERT - CITROËN C4 1.6 HDI
FORD ECOSPORT 1.5 DCI

cm1125-315

Inyector
0445110239

Bosch
F00VC01315
Lucas/Delphi
LDFH0134

Válvula de tercera etapa Bosch

PEUGEOT 307/PARTNER/EXPERT - CITROËN C4 1.6 HDI
FORD ECOSPORT 1.5 DCI

cm1125-329

BOSCH

Válvula de tercera etapa

cm1125-334

Inyector
0445120059 0445120209
0445120060 04451200210
0445120123 0445120211
0445120151 0445120212
0445120152 044512021
0445120208

Bosch
F00VC01334

Válvula de tercera etapa Bosch

FIAT LINEA/PUNTO 1.3 JTD - ALFA ROMEO MITO 1.3
FORD KA 1.3

cm1125-338

Bosch
F00VC01338
Lucas/Delphi
LDFH0155

Válvula de tercera etapa

FIAT DUCATO 3.0 - IVECO DAILY 2,3

cm1125-339

Inyector
0445120007
0445120018
0445120032
0445120079
0445120103

Bosch
F00RJ00339

Válvula de tercera etapa Bosch

FORD CARGO C815/1317E/C1722E/C815 3.9/5.9
IVECO EURO CARGO 3.9/5.9 - VOLKSWAGEN 8150E ISBe4
CUMMINS ISBe4

cm1125-346

Inyector
0445110253 0445110270
0445110254 0445110270
0445110257
0445110258
0445110269

Bosch
F00VC01346

Válvula de tercera etapa Bosch

HYUNDAI SANTA FE 2.2/TUCSON Li3 2.0
CHEVROLET CAPTIVA 2.0 - KIA SPORTAGE 2.0

cm1125-347

Inyector
0445110255
0445110256
0445110319
0445110320
0445110727

Bosch
F00VC01347

Hyundai
33800-2A400

Válvula de tercera etapa Bosch

HYUNDAI I20 1,4 D4FC - HYUNDAI ACCENT/ELANTRA
I20/130 1,6 D4FB - KIA CARENS/SOUL/VENGA 1,6 D4FB

REPUESTOS

cm1125-349

Inyector
0445110249
0445110250



Bosch
F00VC01349

Válvula de tercera etapa

MAZDA BT-50 2.5 / 3.0

cm1125-359

Inyector
0445110355
0445110412
0445110515



Bosch
F00VC01359

Válvula de tercera etapa Bosch

JAC - CHANGFENG - DONGFENG

cm1125-372



Bosch
F00VC01372
Lucas/Delphi
LDFH0187

Válvula de tercera etapa

PEUGEOT PARTNER/EXPERT 1,6HDI
CITROËN BERLINGO 1,6HDI - FORD ECOSPORT 1,5DCI

cm1125-377



Válvula de tercera etapa

BOSCH

cm1125-379



Inyectores
0445110354
0445110424

Bosch
F00VC01379

Válvula de tercera etapa

CHEVROLET S10 MOTOR 2,8 CDTI

cm1125-380



Inyector
0445110375
0445110634

Bosch
F00VC01380

Válvula de tercera etapa Bosch

RENAULT KANGOO EXPRESS/SANDERO/STEPWAY/CLIO 1.6 L
TRAFFIC 1.9 L / CAPTUR/DUSTER/FLUENCE/TRAFFIC/KANGOO/SCENIC II 2.0 L
MASTER III 2.3 DCI / LOGAN/KOLEOS 2.5 L / LAGUNA 2.9 L

cm1125-399

Inyector
0445120009 0445120019
0445120010 0445120020
0445120014 0445120084
0445120015



Bosch
F00RJ00399

Válvula de tercera etapa Bosch

**RENAULT 420 - 370 PREMIUM L
IVECO**

cm1125-447



Inyector
0445120012
0445120013
0445120016

Bosch
F00RJ00447

Válvula de tercera etapa Bosch

RENAULT MIDLUM / PREMIUM 6.2 DCI

cm1125-451



Inyector
0445120136 0445120064
0445120137 0445120065
0445120138 0445120074
0445120139

Bosch Lucas/Delphi
F00RJ01451 LDFH0031
Volvo
2201850422018504

Válvula de tercera etapa Bosch

**RENAULT MIDLUM II 4.8 L / LANDER 7.2 L
VOLVO B 7 R 7.1 L**

cm1125-502

Inyectores Inductivos
0445110646 0445110647
0445110485
0445110368
0445110369



Bosch
F00VC01502

Válvula de tercera etapa Bosch

**VOLKSWAGEN AMAROK/BEETLE/PASSAT
CNEA/CNFA 2.0 - AUDI A3/A4**

cm1125-509



Inyector
0445110485
0445110652

Bosch
F00VC01509

Válvula de tercera etapa Bosch

**RENAULT CAPTUR/SANDERO II/LOGAN II
DUSTER CLIO IV 1.5 DCI - NISSAN KUBISTAR 1.5 DCI**

cm1125-714



Bosch
F00RJ01714
Lucas/Delphi
LDFH0041
LDFH0049

Válvula de tercera etapa

FORD CARGO EURO 5 6,7 ISB

cm1125-895

Inyector
0445120012 0445120017
0445120013 0445120089
0986435525 0445120043
0445120016 5010450532



Bosch
F00RJ01895

Válvula de tercera etapa Bosch

IVECO EURO CARGO 3.9 / 5.9

cm1125-941



Inyector
0445120029 0445120125
0445120037 0445120140
0445120070 1445120236
0445120097 0445120240
0445120120 0445120272

Válvula de tercera etapa Bosch

**FORD CARGO C2632E/C2932E ISC 8.3 -
VOLKSWAGEN 18320/CONSTELLATION 25320 ISC 8.3
CUMMINS ISC 8.3**

cm1125-945



Válvula de tercera etapa

BOSCH

cm1125-3XX

Inyectores 0445110...



Bosch
F00VC01013 F00VC01352 F00VC01367
F00VC01331 F00VC01353 F00VC01368
F00VC01334 F00VC01354 F00VC01371
F00VC01336 F00VC01355 F00VC01376
F00VC01338 F00VC01357 F00VC01377
F00VC01341 F00VC01358 F00VC01378
F00VC01342 F00VC01359 F00VC01379
F00VC01344 F00VC01360 F00VC01380
F00VC01346 F00VC01363 F00VC01383
F00VC01347 F00VC01364
F00VC01348 F00VC01365

Cabeza de válvula de tercera etapa. Bosch universal

**CHEVROLET - CITROËN - PEUGUEOT - KIA
RENAULT**

REPUESTOS

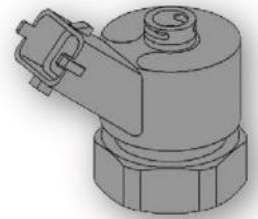
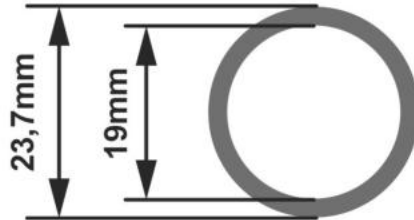

	cm1126-A093A102	
	GROSOR	CANTIDAD
cm1126-A093	0.93	5
cm1126-A094	0.94	5
cm1126-A095	0.95	5
cm1126-A096	0.96	5
cm1126-A097	0.97	5
cm1126-A098	0.98	5
cm1126-A099	0.99	5
cm1126-A100	1.00	5
cm1126-A101	1.01	5
cm1126-A102	1.02	5
	CANTIDAD BOX: 50	

	cm1126-A103A112	
	GROSOR	CANTIDAD
cm1126-A103	1.03	5
cm1126-A104	1.04	5
cm1126-A105	1.05	5
cm1126-A106	1.06	5
cm1126-A107	1.07	5
cm1126-A108	1.08	5
cm1126-A109	1.09	5
cm1126-A110	1.10	5
cm1126-A111	1.11	5
cm1126-A112	1.12	5
	CANTIDAD BOX: 50	

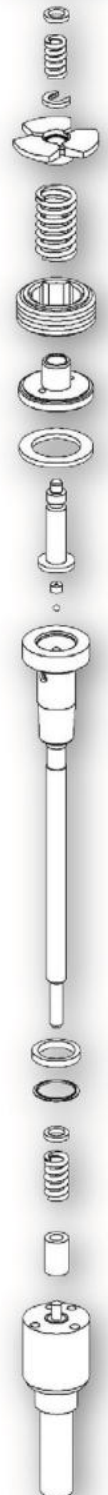

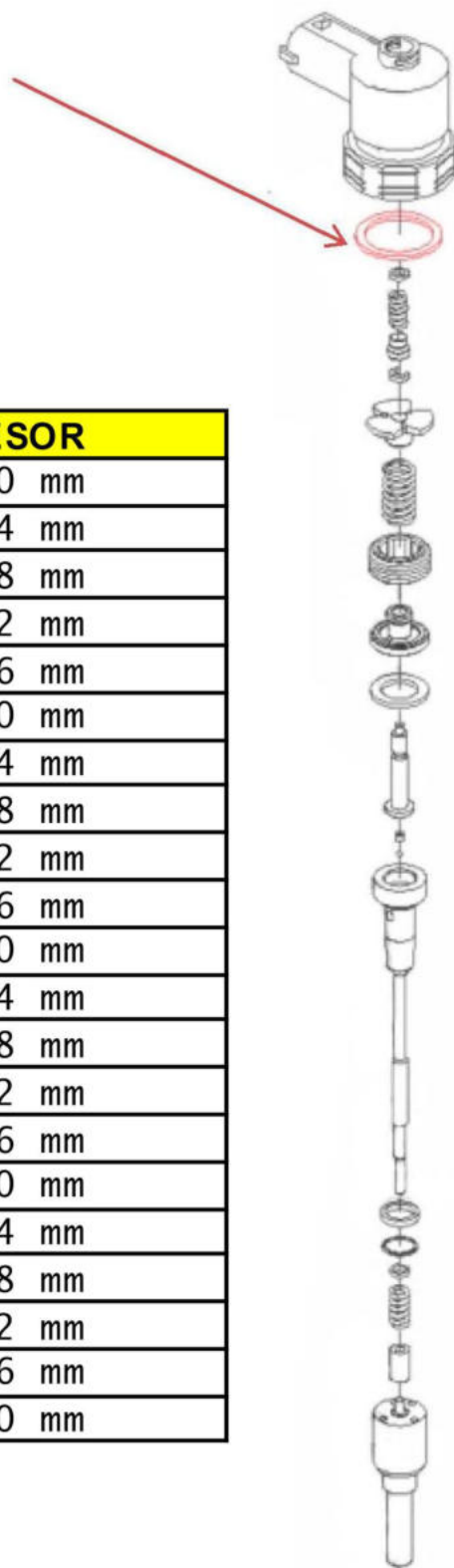
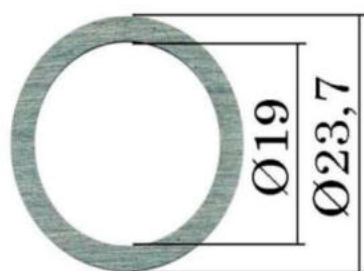

CODIGO CMD	CODIGO BOSCH	ESPESOR
cm1126-A1160	F00VC60325	1,160 mm
cm1126-A1164	F00VC60327	1,164 mm
cm1126-A1168	F00VC60329	1,168 mm
cm1126-A1172	F00VC60331	1,172 mm
cm1126-A1176	F00VC60333	1,176 mm
cm1126-A1180	F00VC60335	1,180 mm
cm1126-A1184	F00VC60337	1,184 mm
cm1126-A1188	F00VC60339	1,188 mm
cm1126-A1192	F00VC60341	1,192 mm
cm1126-A1196	F00VC60343	1,196 mm
cm1126-A1200	F00VC60345	1,200 mm
cm1126-A1204	F00VC60347	1,204 mm
cm1126-A1208	F00VC60349	1,208 mm
cm1126-A1212	F00VC60351	1,212 mm
cm1126-A1216	F00VC60353	1,216 mm
cm1126-A1220	F00VC60355	1,220 mm
cm1126-A1224	F00VC60357	1,224 mm
cm1126-A1228	F00VC60359	1,228 mm
cm1126-A1232	F00VC60361	1,232 mm
cm1126-A1236	F00VC60363	1,236 mm
cm1126-A1240	F00VC60365	1,240 mm

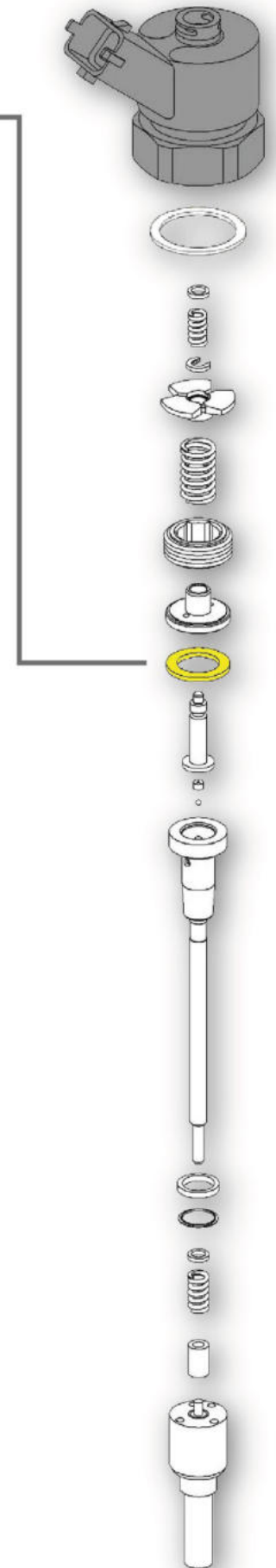
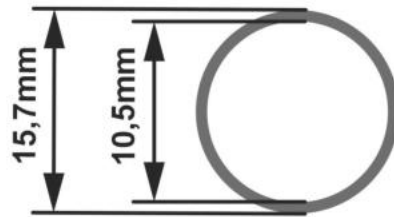

cm1126-B120B129		
	GROSOR	CANTIDAD
cm1126-B120	1.20	5
cm1126-B121	1.21	5
cm1126-B122	1.22	5
cm1126-B123	1.23	5
cm1126-B124	1.24	5
cm1126-B125	1.25	5
cm1126-B126	1.26	5
cm1126-B127	1.27	5
cm1126-B128	1.28	5
cm1126-B129	1.29	5
CANTIDAD BOX: 50		



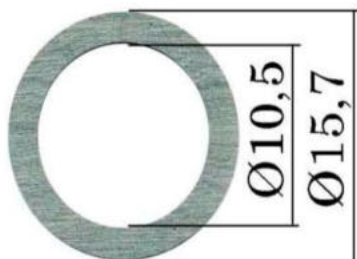

CODIGO CMD	CODIGO BOSCH	ESPESOR
cm1126-B1218	F00VC10414	1,218 mm
cm1126-B1222	F00VC10416	1,222 mm
cm1126-B1226	F00VC10418	1,226 mm
cm1126-B1230	F00VC10420	1,230 mm
cm1126-B1234	F00VC10422	1,234 mm
cm1126-B1238	F00VC10424	1,238 mm
cm1126-B1242	F00VC10426	1,242 mm
cm1126-B1246	F00VC10428	1,246 mm
cm1126-B1250	F00VC10430	1,250 mm
cm1126-B1254	F00VC10432	1,254 mm
cm1126-B1258	F00VC10434	1,258 mm
cm1126-B1262	F00VC10436	1,262 mm
cm1126-B1266	F00VC10438	1,266 mm
cm1126-B1270	F00VC10440	1,270 mm
cm1126-B1274	F00VC10442	1,274 mm
cm1126-B1278	F00VC10444	1,278 mm
cm1126-B1282	F00VC10446	1,282 mm
cm1126-B1286	F00VC10448	1,286 mm
cm1126-B1290	F00VC10450	1,290 mm
cm1126-B1294	F00VC10452	1,294 mm

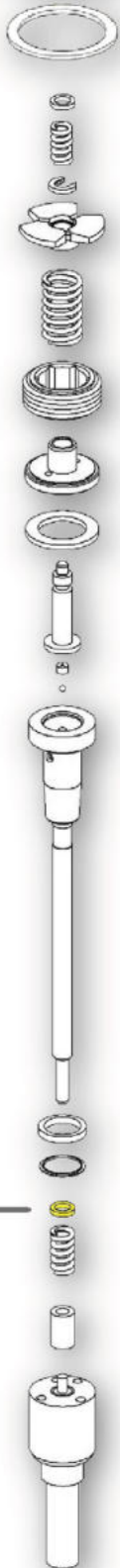
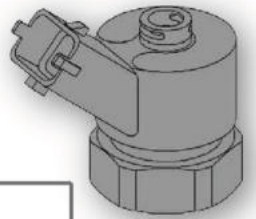
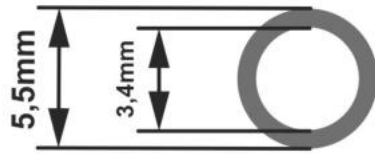

	cm1126-C120C138	
	GROSOR	CANTIDAD
cm1126-C120	1.20	5
cm1126-C122	1.22	5
cm1126-C124	1.24	5
cm1126-C126	1.26	5
cm1126-C128	1.28	5
cm1126-C130	1.30	5
cm1126-C132	1.32	5
cm1126-C134	1.34	5
cm1126-C136	1.36	5
cm1126-C138	1.38	5
CANTIDAD BOX: 50		

	cm1126-C140C158	
	GROSOR	CANTIDAD
cm1126-C140	1.40	5
cm1126-C142	1.42	5
cm1126-C144	1.44	5
cm1126-C146	1.46	5
cm1126-C148	1.48	5
cm1126-C150	1.50	5
cm1126-C152	1.52	5
cm1126-C154	1.54	5
cm1126-C156	1.56	5
cm1126-C158	1.58	5
CANTIDAD BOX: 50		



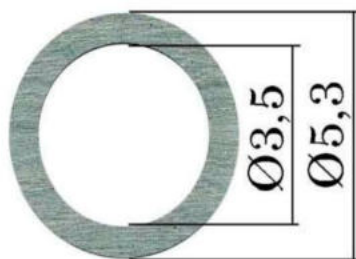

CODIGO CMD	CODIGO BOSCH	ESPESOR
cm1126-C120	F00VC10590	1,20 mm
cm1126-C122	F00VC10592	1,22 mm
cm1126-C124	F00VC10594	1,24 mm
cm1126-C126	F00VC10596	1,26 mm
cm1126-C128	F00VC10598	1,28 mm
cm1126-C130	F00VC10600	1,30 mm
cm1126-C132	F00VC10602	1,32 mm
cm1126-C134	F00VC10604	1,34 mm
cm1126-C136	F00VC10606	1,36 mm
cm1126-C138	F00VC10608	1,38 mm
cm1126-C140	F00VC10610	1,40 mm
cm1126-C142	F00VC10612	1,42 mm
cm1126-C144	F00VC10614	1,44 mm
cm1126-C146	F00VC10616	1,46 mm
cm1126-C148	F00VC10618	1,48 mm
cm1126-C150	F00VC10620	1,50 mm
cm1126-C154	F00VC10624	1,54 mm
cm1126-C158	F00VC10628	1,58 mm
cm1126-C162	F00VC10632	1,62 mm
cm1126-C166	F00VC10636	1,66 mm
cm1126-C170	F00VC10640	1,70 mm

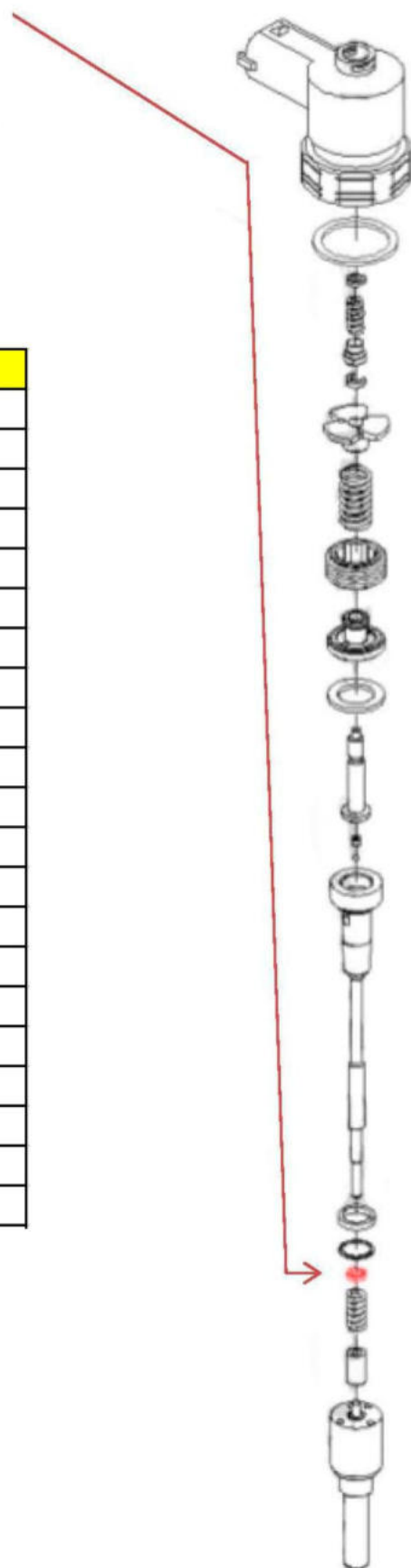

REPUESTOS

cm1126-D140D149		
	GROSOR	CANTIDAD
cm1126-D140	1.40	5
cm1126-D141	1.41	5
cm1126-D142	1.42	5
cm1126-D143	1.43	5
cm1126-D144	1.44	5
cm1126-D145	1.45	5
cm1126-D146	1.46	5
cm1126-D147	1.47	5
cm1126-D148	1.48	5
cm1126-D149	1.49	5
CANTIDAD BOX: 50		

cm1126-D150D159		
	GROSOR	CANTIDAD
cm1126-D150	1.50	5
cm1126-D151	1.51	5
cm1126-D152	1.52	5
cm1126-D153	1.53	5
cm1126-D154	1.54	5
cm1126-D155	1.55	5
cm1126-D156	1.56	5
cm1126-D157	1.57	5
cm1126-D158	1.58	5
cm1126-D159	1.59	5
CANTIDAD BOX: 50		

cm1126-D160D169		
	GROSOR	CANTIDAD
cm1126-D160	1.60	5
cm1126-D161	1.61	5
cm1126-D162	1.62	5
cm1126-D163	1.63	5
cm1126-D164	1.64	5
cm1126-D165	1.65	5
cm1126-D166	1.66	5
cm1126-D167	1.67	5
cm1126-D168	1.68	5
cm1126-D169	1.69	5
CANTIDAD BOX: 50		

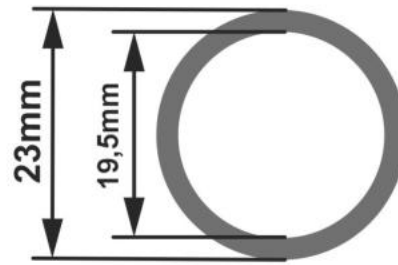

REPUESTOS

CODIGO	cm1126-G107G116	
	GROSOR	CANTIDAD
cm1126-G107	1.07	5
cm1126-G108	1.08	5
cm1126-G109	1.09	5
cm1126-G110	1.10	5
cm1126-G111	1.11	5
cm1126-G112	1.12	5
cm1126-G113	1.13	5
cm1126-G114	1.14	5
cm1126-G115	1.15	5
cm1126-G116	1.16	5
CANTIDAD BOX: 50		

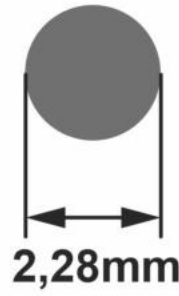

CODIGO	cm1126-G117G126	
	GROSOR	CANTIDAD
cm1126-G117	1.17	5
cm1126-G118	1.18	5
cm1126-G119	1.19	5
cm1126-G120	1.20	5
cm1126-G121	1.21	5
cm1126-G122	1.22	5
cm1126-G123	1.23	5
cm1126-G124	1.24	5
cm1126-G125	1.25	5
cm1126-G126	1.26	5
CANTIDAD BOX: 50		



CODIGO	GROSOR	CANTIDAD
cm1126-G127	1.27	5
cm1126-G128	1.28	5
cm1126-G129	1.29	5
cm1126-G130	1.30	5
cm1126-G131	1.31	5
cm1126-G132	1.32	5
cm1126-G133	1.33	5
cm1126-G134	1.34	5
cm1126-G135	1.35	5
cm1126-G136	1.36	5



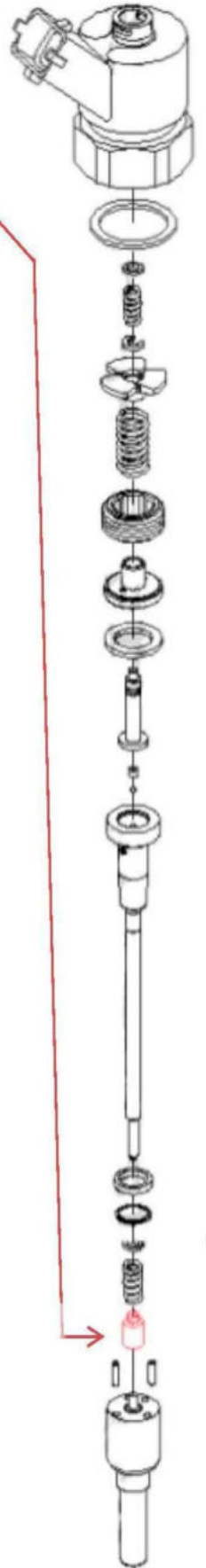

CODIGO CMD	CODIGO BOSCH	ESPESOR
cm1126-J8349	F00VC12324	8,349 mm
cm1126-J8361	F00VC12328	8,361 mm
cm1126-J8373	F00VC12332	8,373 mm
cm1126-J8385	F00VC12336	8,385 mm
cm1126-J8397	F00VC12340	8,397 mm
cm1126-J8409	F00VC12344	8,409 mm
cm1126-J8421	F00VC12348	8,421 mm
cm1126-J8433	F00VC12352	8,433 mm
cm1126-J8445	F00VC12356	8,445 mm
cm1126-J8457	F00VC12360	8,457 mm
cm1126-J8469	F00VC12364	8,469 mm
cm1126-J8481	F00VC12368	8,481 mm
cm1126-J8493	F00VC12372	8,493 mm

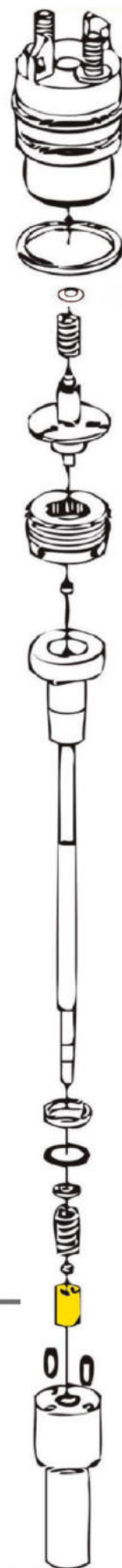

cm1126-K830K839		
	GROSOR	CANTIDAD
cm1126-K830	8.30	5
cm1126-K831	8.31	5
cm1126-K832	8.32	5
cm1126-K833	8.33	5
cm1126-K834	8.34	5
cm1126-K835	8.35	5
cm1126-K836	8.36	5
cm1126-K837	8.37	5
cm1126-K838	8.38	5
cm1126-K839	8.39	5
CANTIDAD BOX: 50		

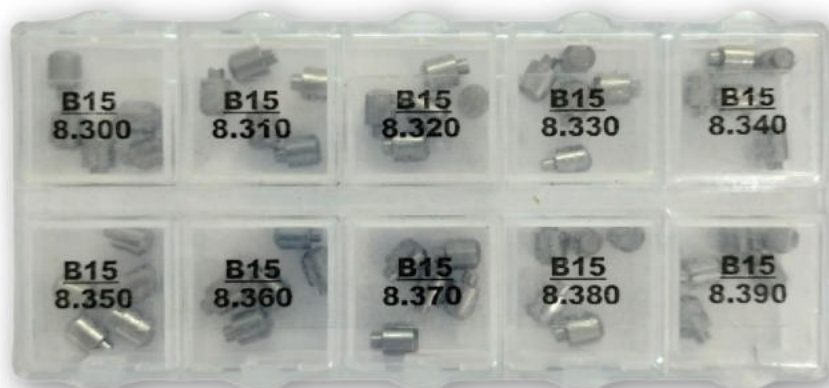

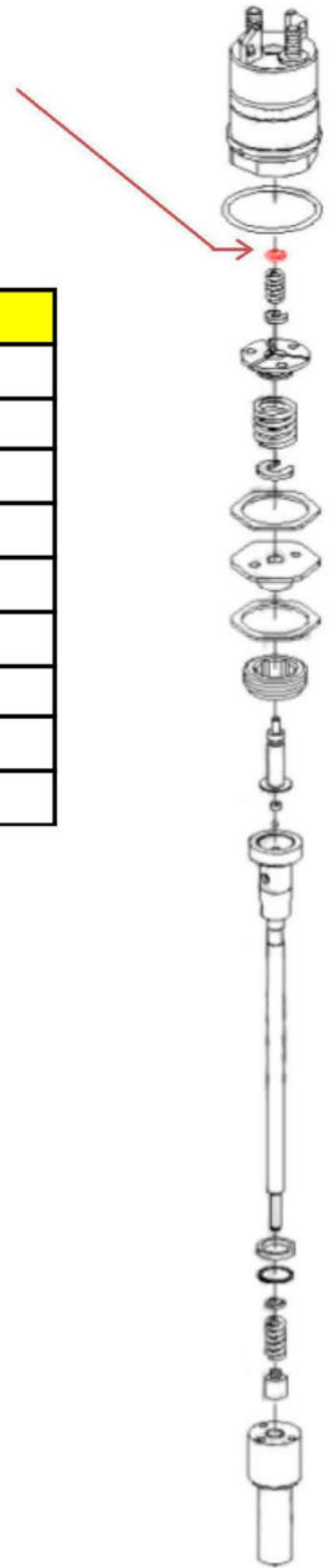
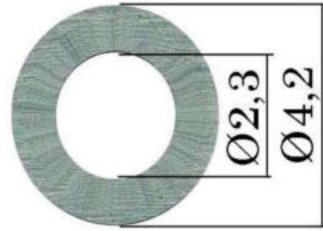

CODIGO CMD	CODIGO BOSCH	ESPESOR
cm1126-L092	F00RJ00189	0,92 mm
cm1126-L096	F00RJ00190	0,96 mm
cm1126-L100	F00RJ00191	1,00 mm
cm1126-L104	F00RJ00192	1,04 mm
cm1126-L108	F00RJ00193	1,08 mm
cm1126-L112	F00RJ00194	1,12 mm
cm1126-L116	F00RJ00195	1,16 mm
cm1126-L120	F00RJ00196	1,20 mm
cm1126-L124	F00RJ00197	1,24 mm

REPUESTOS

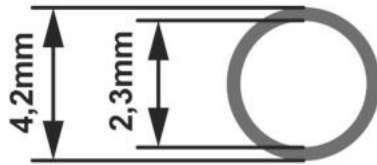

	cm1126-L126L144	
	GROSOR	CANTIDAD
cm1126-L126	1.26	5
cm1126-L128	1.28	5
cm1126-L130	1.30	5
cm1126-L132	1.32	5
cm1126-L134	1.34	5
cm1126-L136	1.36	5
cm1126-L138	1.38	5
cm1126-L140	1.40	5
cm1126-L142	1.42	5
cm1126-L144	1.44	5
	CANTIDAD BOX: 50	

	cm1126-L146L164	
	GROSOR	CANTIDAD
cm1126-L146	1.46	5
cm1126-L148	1.48	5
cm1126-L150	1.50	5
cm1126-L152	1.52	5
cm1126-L154	1.54	5
cm1126-L156	1.56	5
cm1126-L158	1.58	5
cm1126-L160	1.60	5
cm1126-L162	1.62	5
cm1126-L164	1.64	5
	CANTIDAD BOX: 50	



REPUESTOS

cm1126-P11IP120		
	GROSOR	CANTIDAD
cm1126-P111	1.11	5
cm1126-P112	1.12	5
cm1126-P113	1.13	5
cm1126-P114	1.14	5
cm1126-P115	1.15	5
cm1126-P116	1.16	5
cm1126-P117	1.17	5
cm1126-P118	1.18	5
cm1126-P119	1.19	5
cm1126-P120	1.20	5
CANTIDAD BOX: 50		

cm1126-P12IP130		
	GROSOR	CANTIDAD
cm1126-P121	1.21	5
cm1126-P122	1.22	5
cm1126-P123	1.23	5
cm1126-P124	1.24	5
cm1126-P125	1.25	5
cm1126-P126	1.26	5
cm1126-P127	1.27	5
cm1126-P128	1.28	5
cm1126-P129	1.29	5
cm1126-P130	1.30	5
CANTIDAD BOX: 50		

cm1126-P13IP140		
	GROSOR	CANTIDAD
cm1126-P131	1.31	5
cm1126-P132	1.32	5
cm1126-P133	1.33	5
cm1126-P134	1.34	5
cm1126-P135	1.35	5
cm1126-P136	1.36	5
cm1126-P137	1.37	5
cm1126-P138	1.38	5
cm1126-P139	1.39	5
cm1126-P140	1.40	5
CANTIDAD BOX: 50		

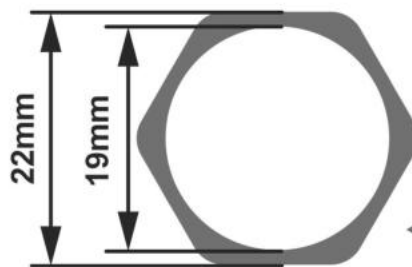

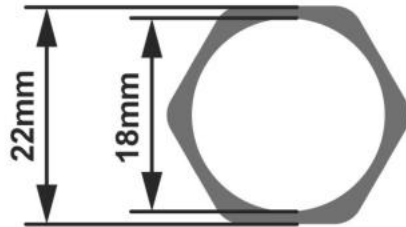

cm1126-R090R099		
	GROSOR	CANTIDAD
cm1126-R090	0.90	5
cm1126-R091	0.91	5
cm1126-R092	0.92	5
cm1126-R093	0.93	5
cm1126-R094	0.94	5
cm1126-R095	0.95	5
cm1126-R096	0.96	5
cm1126-R097	0.97	5
cm1126-R098	0.98	5
cm1126-R099	0.99	5
CANTIDAD BOX:		50

cm1126-R100R109		
	GROSOR	CANTIDAD
cm1126-R100	1.00	5
cm1126-R101	1.01	5
cm1126-R102	1.02	5
cm1126-R103	1.03	5
cm1126-R104	1.04	5
cm1126-R105	1.05	5
cm1126-R106	1.06	5
cm1126-R107	1.07	5
cm1126-R108	1.08	5
cm1126-R109	1.09	5
CANTIDAD BOX:		50





CODIGO CMD	CODIGO BOSCH	ESPEJOR
cm1126-R0982	F00RJ00040	0,982 mm
cm1126-R0986	F00RJ00042	0,986 mm
cm1126-R0990	F00RJ00044	0,990 mm
cm1126-R0994	F00RJ00046	0,994 mm
cm1126-R0998	F00RJ00048	0,998 mm
cm1126-R1002	F00RJ00050	1,002 mm
cm1126-R1006	F00RJ00052	1,006 mm
cm1126-R1010	F00RJ00054	1,010 mm
cm1126-R1014	F00RJ00056	1,014 mm
cm1126-R1018	F00RJ00058	1,018 mm
cm1126-R1022	F00RJ00060	1,022 mm
cm1126-R1026	F00RJ00062	1,026 mm
cm1126-R1030	F00RJ00064	1,030 mm
cm1126-R1034	F00RJ00066	1,034 mm

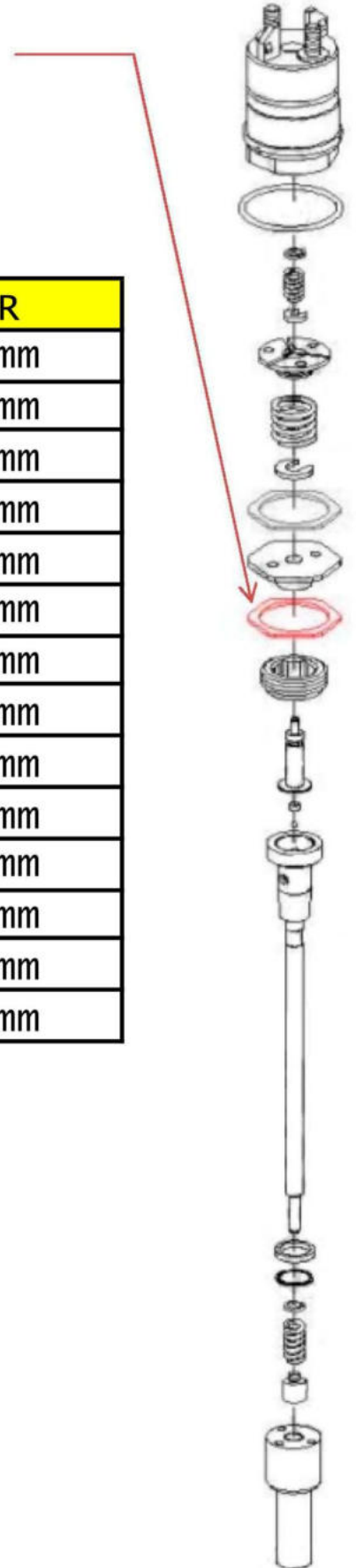



CODIGO CMD	CODIGO BOSCH	ESPEJOR
cm1126-z094	F00RJ00772	0,94 mm
cm1126-z097	F00RJ00775	0,97 mm
cm1126-z100	F00RJ00778	1,00 mm
cm1126-z103	F00RJ00781	1,03 mm
cm1126-z106	F00RJ00784	1,06 mm
cm1126-z109	F00RJ00787	1,09 mm
cm1126-z112	F00RJ00790	1,12 mm
cm1126-z115	F00RJ00793	1,15 mm
cm1126-z118	F00RJ00796	1,18 mm
cm1126-z121	F00RJ00799	1,21 mm
cm1126-z127	F00RJ00805	1,27 mm
cm1126-z133	F00RJ00811	1,33 mm
cm1126-z139	F00RJ00817	1,39 mm

REPUESTOS

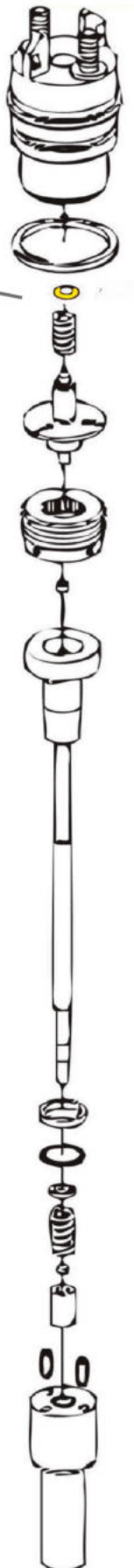
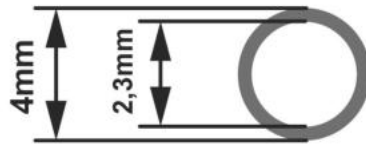

	cm1126-Z120Z138	
	GROSOR	CANTIDAD
cm1126-Z120	1.20	5
cm1126-Z122	1.22	5
cm1126-Z124	1.24	5
cm1126-Z126	1.26	5
cm1126-Z128	1.28	5
cm1126-Z130	1.30	5
cm1126-Z132	1.32	5
cm1126-Z134	1.34	5
cm1126-Z136	1.36	5
cm1126-Z138	1.38	5
	CANTIDAD BOX: 50	

	cm1126-Z140Z158	
	GROSOR	CANTIDAD
cm1126-Z140	1.40	5
cm1126-Z142	1.42	5
cm1126-Z144	1.44	5
cm1126-Z146	1.46	5
cm1126-Z148	1.48	5
cm1126-Z150	1.50	5
cm1126-Z152	1.52	5
cm1126-Z154	1.54	5
cm1126-Z156	1.56	5
cm1126-Z158	1.58	5
	CANTIDAD BOX: 50	



REPUESTOS

cm1128-697



Inyectores
0445120...

Bosch
F00RJ02697

Grupo magnético (Solenoid)

CRIN 114/16

REPUESTOS

cm1141-001



Bosch
0281002493

Válvula reguladora de presión

CITROËN BERLINGO 2.0 HDI PEUGEOT 206/306/406/806/
EXPERT/PARTNER - 20CC HDI

cm1141-002



Bosch
0281002872

Válvula reguladora de presión

CITROËN BERLINGO 2.0 HDI PEUGEOT 206/306/406/806/
EXPERT/PARTNER - 20CC HDI

cm1141-003



Bosch
0281002241
Mercedes Benz
6110780149

Válvula reguladora de presión

MERCEDES SPRINTER
208/211/213/216/308/311/313/316/411/413/416/616
MERCEDES BENZ A160/A170/VANEO 17/C270/C30/CLK270/
E270/G270/ML270/E320/S320

cm1141-004



Bosch
0281002698
Mercedes Benz
6110780549

Válvula reguladora de presión

MERCEDES SPRINTER
208/211/213/216/308/311/313/316/411/413/416/616
MERCEDES BENZ A160/A170/C200/C220/C270/C30/
CLK270/E200/E220/E270/E320/E400/G400/ML270/ML400/S320/
S400/V200/220 - VANEO 17

cm1141-005



Bosch
0281002500
Mercedes Benz Fiat
6110780549

Válvula reguladora de presión

FIAT DUCATO 2.8 TJD - IVECO DAILY 2.8 JTD
RENAULT MASCOTTE 110 DCI

cm1141-006



Bosch
0281002284

Válvula reguladora de presión

PEUGEOT 206 2.0 - CITROËN

cm1141-007



Bosch
0281002483
Renault
7701052268

Válvula reguladora de presión

RENAULT LAGUNA/MEGANE/SCENIC
1.9 DCI/1.9 DTI

cm1141-008



Bosch
0281002480
0281002287
BMW
13517787537
13512247848

Válvula reguladora de presión

BMW 330D/525D/530D/730D/X5

cm1141-009



Bosch
0281002493
0281002488
0281002243
Fiat
71718445
60816659

Válvula reguladora de presión

ALFA ROMEO 159 1.9 JTD - FIAT

cm1141-010



Bosch
0281002718

Válvula reguladora de presión

HYUNDAI XTREE - KIA TRAJET
2.0 CRDI

cm1141-011



Bosch
0281002445

Válvula reguladora de presión

HYUNDAI SANTA FE/TUCSON/XTREK/TRAJET XG VGT 2.0
KIA CARENS II 2.0

cm1141-012



Bosch
0281002698
Mercedes Benz
6110780549

Válvula reguladora de presión

FORD KA 1.3 TDCI - FIAT 500/FIORINO/DOBLO/IDEA
1.3 MULTIJET
HYUNDAI H1 2.5 CRDI/130 1.6 CRDI - 2.0 CRDI/SANTA FE
2.2 CRDI

REPUESTOS

cm1141-014



Bosch
0281002682
Mercedes Benz
A6480700046

Válvula reguladora de presión de ramba CR 0445214129
MERCEDES BENZ CLS 320/350 E320 ML 320/350 CDI 3.0 SPRINTER 2500/3500

cm1141-015



Bosch
0281002738
BMW
13537805734

Válvula reguladora de presión de ramba CR 0445214134
0445214182 0445214216

BMW X5/E60/E70 3.0D

cm1141-016



Bosch
0281002794
0281002795
Mercedes Benz
A6420780149

Válvula reguladora de presión de ramba CR 0445214108
04452141606

MERCEDES BENZ VIANO/VITO/SPRINTER 2.0/2.2

cm1141-017



Bosch
0281002829

Válvula reguladora de presión de ramba CR 0445214119 0445214265

HYUNDAI IX55 3.0 V6 CRDI
KIA MOHAVE 3.0 V6 CRDI

cm1141-018



Bosch
0281002949

Válvula reguladora de presión de ramba CR 0445214053

BMW SERIE 1 E81/87/88/82/F20/21/22
SERIE 3 E90/91/92/93/F30/31/34 - SERIE 4 F32/33/36
SERIE 5 F07 GT/F10/F11 - SERIE X X1E84/X3 E83/X3 F25/X5 F15

cm1141-019



Bosch
0281002943
0281002718
0281002732
Hyundai
3140227010

Válvula reguladora de presión de ramba CR 0445213007

HYUNDAI ACCENT 1.5/SANTA FE 2.0
KIA CARENS/SPORTAGE/CERATO 2.0

cm1141-021



Bosch
0281006002
0281002351
0281002352
0281002858
0281006003
0281006074
081006075

Volkswagen
057130755AH
057130760AB
057130764AB

Válvula reguladora de presión de ramba CR

AUDI A3/A4/A5/A6/Q2/Q3/Q5 - VOLKSWAGEN AMAROK
GOLF/PASSAT/SHARAN/TOUAREG 2.0 TDI

cm1141-022



Bosch
0281006032
0281002507
0281002625

Válvula reguladora de presión de ramba CR 0445214515 0445214516

FIAT DUCATO 3.0 MULTIJET - IVECO DAILY 3.0

cm1141-023



Bosch
0281006037
Hyundai
314022F000

Válvula reguladora de presión de ramba CR 0445214211 0445216040

HYUNDAI SANTA FE 2.0/2.2 CRDI

cm1141-024



Bosch
0281006074
0281002351
0281002352
0281006075

Volkswagen
057130755AH
057130760AB
057130764AB

Válvula reguladora de presión de ramba CR

AUDI A3/A4/A5/A6/Q2/Q3/Q5 - VOLKSWAGEN AMAROK
GOLF/PASSAT/SHARAN/TOUAREG/TIGUAN 2.0 TDI

REPUESTOS

cm1142-035



Bosch
0281006035
Hyundai
314012F000

Sensor de presión de ramba CR 0445214211 0445216041

HYUNDAI SANTA FE 2.0/2.2 CRDI/TUCSON 2.0
KIA CARNIVAL 2.2 CRDI/SORENTO 2.0/2.2 CRDI
SPORTAGE 2.0 CRDI

cm1142-053



Bosch
0281006053
0281002706
0281002707
0281006158
0281006244
0281006364
0281006425

Ford
04216218
Hino
5227621090
Volvo
21407309
7421-40-7309
7421-45-5919

Sensor de presión de ramba CR 0445214070

NISSAN URVAN 3.0 ZD30 - RENAULT LAGUNA
TRAFFIC/MASTER 1.9/2.2 DCI TRUCKS (TODOS)

cm1141-325



Bosch
0281006325
0281006112
Cummins
3974092
5260246
5297641

Bosch
1705135
Fiat
42574913
Ford
BG6X 9F479 CA
Iveco
42567283
Volkswagen
2T2 906 051 B

Sensor de presión de ramba CR

FORD 2500/CARGO C1317E/C1517E/C1717E
F100 DUTY/MAX POWER - IVECO EUROARGO
VOLKSWAGEN 9150E INTERACT 4.0 EURO 3

REPUESTOS

cm1142-671



Bosch
0281002671
0281002672
0281002842
BMW
13537794758
Mercedes Benz
A0041536728
A0061533328
A0061536528

Sensor de presión de rampa CR 0445214096 0445214108 0445214129 0445214148

**BMW 745 D - JEEP GRAND CHEROKEE 3.0 CRD
MERCEDES BENZ 2.1/2.2/2.7/3.0/4.0 CRD
OM629/640/642/646/648**

cm1142-842



Bosch Mercedes Benz
0281002842 A0041536728
0281002504 A0061533328
0281002505 A0061536528
0281002671
0281002672
0281002843

Sensor de presión de rampa CR 0445214072 0445214160 0445214162

**AUDI V6 3.0 TDI - BMW 7 745D 4.4 - JEEP GRAND CHEROKEE 3.0 CRD
MERCEDES BENZ 2.1/2.2/2.7/3.0/3.2/4.0 OM626/629/640
642/646/647/648**

cm1142-846



Bosch
0281002846
Case
2831362
Ford
2C469F972CA
Iveco
42561376

Sensor de presión de rampa CR 0445214125 0445214125

**CASE - CUMMINS - DODGE RAM 3500 [2004-2007] - FORD CARGO
C 172Z 8.3L 12V SOHV L6/ C 815 3.9L 8V SOHV L4 - IVECO**

cm1142-863



Bosch
0281002863
0281006808

Sensor de presión de rampa CR 0445213017 0445214180

HYUNDAI - KIA 1.7/2.0/2.5 CRDI

cm1142-907



Bosch
0281002907
0281002720
0281002920

Sensor de presión de rampa CR 0445214082 0445224026

CHEVROLET S10 - NISSAN FRONTIER 2.8 MWM

cm1142-908



Bosch
0281002908
0281002568
0281002734
0281002865
KIA
314004A010

Sensor de presión de rampa CR 0445214066 0445214061

**KIA SORENTO 2.5 CRDI - RENAULT MASTER 2.2/2.5 DCI
VOLKSWAGEN TRUCKS WORKER 4.7**

cm1142-909



Bosch Iveco
02810002909 42567918
0281002522 42569152
0281002788 504229208
0281002866 **Renault**
0281002867 7701068387
0281002867 7701069617
Fiat
504229208 7701474554
Hyundai 7701478058
31401-27000 8200600206
31401-27001 8200600208

Sensor de presión de rampa CR 0445214035 0445214036

**AGRALE MWM 4.07 TCE - CITROËN JUMPER 2.8 - FIAT DUCATO 2.8 JTD
HYUNDAI ELANTRA/SANTA FE/TRAJET/TUCSON 2.0 CRDI
IVECO DAILY 2.8 JTD - KIA CARENS/CERATO/SPORTAGE/XTRAK 2.0 CRDI**

cm1142-930



Bosch
0281002930
Ford
6C469F972AA
Iveco
504333094
MAN
51274210233
Volvo
21946209

Sensor de presión de rampa CR 0445214240 0445214254 0445214224

IVECO EURO CARGO - MAN TGL/TGM/TGX/TGS

cm1142-937



Bosch Fiat Volvo
0281002937 504152959 20792328
0281002700 55195078 21407309
0281002706 5802186887 30677300
0281002707 **Iveco** 3843100
0281002942 504152959
0281006022 504247741
0281006304 504382372
Alfa Romeo 55207677
46812910 **MAN**
Cummins 51274210229
5260246 51274210230
Lancia 51274210236
46812910 51274240178

Sensor de presión de rampa CR

**ALFA ROMEO 147 159 JTD - CHEVROLET S10/DURAMAX
FIAT DUCATO/DOBLO/STILO - IVECO DAILY/EURO CARGO 170
KOMATSU PC200-8/240-8 EXCAVADORA**

cm1142-942



Bosch
0281002942
0281002700
0281002937
0281006022
Mercedes Benz
A0051535828

Sensor de presión de rampa CR

**MERCEDES BENZ SPRINTER
311/313/411/413 OM611**

REPUESTOS

cm1161-004



Bosch
1987972076

Arandela asiento inyector Bosch

MERCEDES BENZ CDI

cm1161-004A



Bosch
1987972076

Arandela asiento inyector Bosch - Plana con muescas

MERCEDES BENZ CDI

cm1161-005

7,2x12,8x1,5MM



Bosch
F00VP01004

Arandela de cobre 4 muescas, asiento inyector
VOLKSWAGEN AMAROK/TIGUAN - 2010 A 2012 2,0L - CDBA/CDCA
VOLKSWAGEN AMAROK/TIGUAN 2012 EN ADELANTE
2,0L - CNFA / CNEA / CSHA

REPUESTOS

cm1161-006

7,5x15x1,5MM



Bosch
F00VC17503
Mercedes Benz
A0000171760
Peugeot
198143
Iveco
4899689

Arandela de cobre 4 muecas, asiento inyector
IVECO TECTOR / EUROARGO CUMMINS - PEUGEOT
VOLKSWAGEN PESADOS - MERCEDES BENZ - FIAT - FORD

cm1161-006A

7,5x15x1 MM



Bosch
F00VC17502

Arandela de cobre 4 muecas, asiento inyector
PEUGEOT - RENAULT - FIAT - FORD
CHEVROLET - IVECO

cm1161-006B

7,5x15x2 MM



Bosch
F00VC17504
Peugeot
198195
Renault
8200895280
Iveco
8099055

Arandela de cobre 4 muecas, asiento inyector
PEUGEOT - RENAULT - FIAT - FORD
CHEVROLET - IVECO

cm1161-006C

7,5x15x2,5 MM



Bosch
F00VC17505
Cummins
5288374
Volkswagen Pesados
057130219A
046130219A

Arandela de cobre 4 muecas, asiento inyector
CUMMINS - VOLKSWAGEN PESADOS

cm1161-006D

7,5x15x3 MM



Bosch
F00VC17506

Arandela de cobre 4 muecas, asiento inyector
RENAULT

cm1161-007

7,6x17,3x4 MM



Arandela de cobre asiento inyector
CASE 1021F 8.7L 2010-2016/AS800 8.7L 2017-2019
IVECO CROSSWAY 8.7L 2014-2019/MAGELYS 8.7L 2014
STRALIS HI-WAY 8.7L 2013-2017/STRALIS X-WAY 8.7L 2017-2018
TRAKKER 8.7L 2013-2015/URBANWAY 8.7L 2013
NEW HOLLAND CR6.80 8.7L 2016-2019/CR7.90 8.7L 2014-2017
CR9060 8.7L 2007-2019/T8.275 8.7L 2013-2014/T9.435 8.7L 2014

cm1162-001

M12 X 1,5 - M12 X 1



Bosch
F00R0P0471

Conexión, sin filtro - Zincado

BOSCH CP1/K3

cm1162-002

Ø 10mm



Bosch
F00R0P0623

Conexión de latón

BOSCH CP1

cm1199-001

Ø 1,34 mm



Bosch
F00VC05001

Kit 50 Esferas de válvula Inyector Common Rail

BOSCH

cm1199-001C

Ø 1,34 mm



Bosch
F00VC05008

Kit de 50 bolillas de cerámica

BOSCH - COMMON RAIL

cm1199-002

Ø 1,8 x 6mm



Bosch
2433201024

Pernos cilindricos para inyectores

BOSCH

cm1199-003

Ø 1,8 x 9mm



Bosch
2433201024

Pernos cilindricos para inyectores

BOSCH

cm1199-004

Para tubería 4mm.



Conexión para retorno de combustible

VS

cm1199-005

Para tubería 4mm.



Conexión para retorno de combustible

VS

cm1199-005A



Conector para retorno

BOSCH

cm1199-006

Ø 1,50mm.



Bosch
F00VC05006

Bolillas de acero para válvula de inyector

BOSCH

cm1199-008



Bosch
F00RJ00414
Cummins
4897114

Cánula de inyector Cummins CR

IVECO EUROARGO - CUMMINS

cm1199-008A

Cánula para inyector

CUMMINS

REPUESTOS

cm1199-010

Bosch
F00RJ04084
F00RJ00753
F00RJ02321

Cánula tubo de presión para inyector

MAN - VOLKSWAGEN CONSTELLATION
cm1199-011

Cummins
5346206
4929864
Bosch
F00RC00647
F00RJ01831
F00RJ01572
F00RJ01224

Cánula tubo de presión para inyector

 FORD CARGO 1723 2423 CUMMINS ISB 6.7 -
VOLKSWAGEN CONSTELLATION 17330 24330 26390 CUMMINS ISL 8.9
DODGE RAM 2500 / 3500 CUMMINS
KOMATSU RETROEXCAVADORA CUMMINS ISB QSB 4.5

cm1199-031
Bosch
F01M101785

Filtro para bombas alta presión CP1H

COMMON RAIL
cm1199-021

Bosch
F00RJ02537

Capuchón protector de plástico para tobera

BOSCH - COMMON RAIL
cm1202-001

Delphi
7135-479A
7135-539

Juego de juntas

RENAULT CLIO/KANGOO/MEGANE K9K
FORD FOCUS C-MAX 1.6/1.8 TDCI
cm1499-001

Denso
095229 0010

Microfiltro para inyector Common Rail

TOYOTA 2.5/3.0
cm1499-002
Denso
095229 0010

Semiesfera interior - Cerámica

COMMON RAIL - DENSO
cm1499-003

Denso
23390-0E010
23390-0E011
23390-11231

Filtro de combustible para bomba de alta presión

TOYOTA HILUX 2016 A 2021 - 1GD 2.8/2GD 2.8
cm2199-001

Ø 18 x 5mm



Plaqueta

BOSCH
cm2199-002

Ø 18 x 5mm



Plaqueta

VOLVO
cm2199-003

Perno de presión

BOSCH
cm2199-004

Bosch
1417010996
Volkswagen
03G198051

Kit para Volkswagen

VOLVO
cm2199-005

Bosch
1413127045
1413127082
Volkswagen
038130335A

Perno para Volkswagen

BOSCH PDE80

REPUESTOS

cm1203-903

Lucas/Delphi 9109-903
Nissan 17065BN700
Citroën Renault 7701206905
1933.29
Ford Suzuki 15213-84A01
1329098
454Q9G586AA

Válvula reguladora de presión Delphi

 RENAULT CLIO/SANDERO/SCENIC III/KANGOO
DUSTER/MEGANE 1.5 DCI - FORD FOCUS 1.8 TDCI
TRANSIT/MONDEO 2.0 TDCI / MONDEO 2.2 TDCI

cm1203-903A

Lucas/Delphi
9109-903A

Válvula reguladora de presión Delphi

KIA CARNIVAL I 2.2 L
cm1203-530A

 Para bomba Delphi
A6510740084/28269520

Lucas/Delphi Hyundai
9307-530A 33115-4A400
9109-930A 33115-4A000
7135-818
9109-946
28233374

Válvula reguladora de caudal DMB

 MERCEDES BENZ SPRINTER - KIA K2500 K2900
HYUNDAI H1 H100 - CHEVROLET CAPTIVA/CRUZE

REPUESTOS

cm1203-936A

Lucas/Delphi
9109-936A
28233373
28466222

Válvula reguladora de presión Delphi

PEUGEOT 3008
cm1303-001

Siemens
X29-800-300-005Z
S5W/X39005Z
VDO
A2C59506225

 Válvula reguladora de presión bomba Siemens
PEUGEOT 306/307 HDI
FORD FIESTA/ECOSPORT 1.4 HDI
CITROËN HDI C3/C4/C5/PICASSO/XSARA/BERLINGO

cm1303-002

VDO
A2C20000704

Válvula reguladora de presión bomba

FORD RANGER 3.0 POWER STROKE
cm1303-003

VDO
A2C20000704

 Ficha de reemplazo para adaptar
válvula Siemens - De recta a 90°

FORD RANGER 3.0 POWER STROKE
cm1403-001

Denso
04226-0L010
294200-0040

Válvula reguladora de presión de combustible

TOYOTA REFORMA - DENSO
cm1403-001A

Denso
04226-0L010
294200-0040

Válvula reguladora de presión de combustible

TOYOTA REFORMA - DENSO
cm1403-002

Mitsubishi
294200-0360
294009-0250
294009-0251
294200-0300

Válvula reguladora de presión - Denso

TOYOTA - MITSUBISHI L200
NISSAN NP300 - MAZDA
cm1403-002A

Mitsubishi
294200-0360
294009-0250
294009-0251
294200-0300

Válvula reguladora de presión - DMB

TOYOTA - MITSUBISHI L200
NISSAN NP300 - MAZDA
cm1403-005

Válvula reguladora de presión

TOYOTA 3.0/2.5
cm1403-005A

Válvula reguladora de presión

TOYOTA 3.0/2.5 ALTERNATIVA
cm1403-006A

Válvula reguladora de presión

CHEVROLET S10
cm1403-007A

Denso
294200-0300
294200-0160
294200-0370

Válvula regula de presión de combustible corta

TOYOTA 2.5/3.0
cm1403-008

Denso
294200-0270
294009-1221
Hyundai
04226-E0061
Isuzu
33130-45700

Válvula reguladora de presión de combustible

HYUNDAI - HINO - ISUZU
cm1403-009

Denso
294200-0380
294200-0130
294050-0060
John Deere
RE534733

Válvula reguladora de presión de combustible

JOHN DEERE TRACTOR S450 6068/60980
TOYOTA RAV4 - HINO - ISUZU 6HK1
cm1403-010

Denso
294200-2750
294200-4750

 Válvula reguladora para bomba alta presión
8-98145484-1

ISUZU 6HK1/4HK1/4JK1 4JJ1
MITSUBISHI L200/TRITON 2.5 DT

REPUESTOS

cm1223-001

Lucas Delphi
9810096

Tuerca portatobera C/R Delphi

DELPHI
PT 170/95

Portatobera para tobera 79PBD

FORD FOCUS
PT 170/96

Portatobera para tobera L 12 PBD A 1601

FORD FOCUS - DELPHI ELECTRÓNICO

REPUESTOS

PT 170/97



Portatobera

RENAULT CLIO - DELPHI ELECTRÓNICO

cm1225-621C



Válvula de tercera etapa

FORD FOCUS 1,8DCI - RENAULT CLIO/KANGOO LOGAN/SANDERO/MEGANE 1,5DCI

Lucas/Delphi
9308-621C
28239294
28440421
28538389
28239295
28278897

cm1225-622B



Valvula plaqueta de control de inyector Delphi

PEUGEOT 407 / FORD MONDEO CITROËN C5

Lucas Delphi
9308-622B
9308-622A
28278897
28239295

cm1225-625c



Válvula plaqueta de control de inyector Delphi

MERCEDES BENZ SPRINTER 411/415 - OM651 CHEVROLET CAPTIVA/CRUZE

Lucas Delphi
9308-625C
9308-684C
28264952
28297167
28362727
28277576
28297165

REPUESTOS

cm1242-511A



Sensor de presión Delphi

RENAULT CLIO/KANGOO/SANDERO/MEGANE II 306/307/308/408 MOTOR 1.5 DCI CITROËN C3 1.4 HDI C4 1.6 HDI - FORD RANGER 3.0 POWERSTROKE

Lucas/Delphi
9307-511A
9307Z507A
28389848
55pp02-02
ED1920GW
5WS40006
5WS40039
98137355

cm1242-521A



Sensor de presión Delphi

MERCEDES BENZ SPRINTER 415/515 OM651

Lucas/Delphi
9307-521A
28389851
55pp22-01

cm1340-001



Rampa con sensor 6PH1001

CITROËN BERLINGO HDI PEUGEOT 307 HDI - FORD TDCI 1.6

Siemens
9654590

cm1442-0045



Sensor de presión de combustible para riel

CHEVROLET S10

cm1442-6121



Sensor de presión de combustible para riel

TOYOTA PRADO/HIACE/HILUX 3.0 D4D

Denso
499000-6121
Toyota
89458-71010

cm1442-6131



Sensor de presión de combustible para riel

TOYOTA 1KD - 2KD NISSAN NAVARA D40 / ISUZU

Denso
499000-6131
499000-6131
Isuzu
8981197900

cm1442-6141



Sensor de presión de combustible para riel

ISUZU

Denso
499000-6141
499000-6160

REPUESTOS

cm1302-001

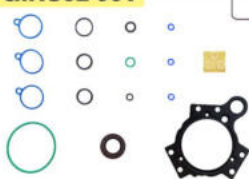

Juego de juntas para bombas

SIEMENS

cm1302-002



Juego de juntas para bomba

FORD RANGER 2.2/3.5

cm1302-003



Juego de juntas para bomba

PEUGEOT VDO DW4TD

cm1302-004

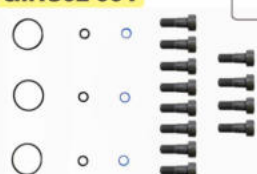

Juego de juntas

FORD RANGER PUMA 2.2/3.2 VDO

cm1303-001A



Siemens
X39800300005Z
A2C59506225

Válvula reguladora de presión de bomba CR
**CITROËN C4 1.6HDI - FORD RANGER 3.0
POWERSTROKE - PEUGEOT 308/408 1.6 HDI**

cm1303-006



Bosch
X398000300006Z

Válvula dosificadora de caudal de bomba CR
**CITROËN C3 1.4HDI - FORD ECOSPORT/FIESTA/FOCUS 1.4 TDCI
RANGER 3.0 POWERSTROKE - PEUGEOT 207 1.4HDI**

cm1325-001



Válvula para inyector (Dos piezas)

SIEMENS

cm1325-002



Kit completo para reparación de inyector - 10 piezas

PEUGEOT 307/408 - CITROEN C3/C4 MOTOR 1.6 HDI

cm1402-001



Denso
294009-0030
294009-0031
294009-0032

Juego de juntas universal

TOYOTA - NISSAN

REPUESTOS

cm1322-P150



Inyectores Siemens
77550 1746967
A2C59517051 5WS40745
BK2Q9K546AG 1840747
CK4Q9K546AA

VDO
M1600P150
150PM1600

Tobera Common Rail M1600P150 150PM1600

FORD RANGER MOTOR 3.0

REPUESTOS

cm1399-001



Conector plástico para retorno de inyectores Siemens
**FORD FIESTA 1.4 ECOSPORT 1.4 FORD RANGER 3.0
CITROËN C3/C4**

cm1399-002



Conector plástico para retorno de inyectores Siemens
FORD RANGER 2.2/3.2

REPUESTOS

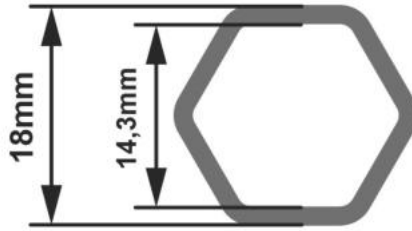

cm1326-A090A099		
	GROSOR	CANTIDAD
cm1326-A090	0.90	5
cm1326-A091	0.91	5
cm1326-A092	0.92	5
cm1326-A093	0.93	5
cm1326-A094	0.94	5
cm1326-A095	0.95	5
cm1326-A096	0.96	5
cm1326-A097	0.97	5
cm1326-A098	0.98	5
cm1326-A099	0.99	5
CANTIDAD BOX: 50		



REPUESTOS

cm1403-010



Denso
294200-2750
294200-4750

Válvula reguladora para bomba alta presión 8-98145484-1

ISUZU 6HK1/4HK1/4JK1 4JJ1

cm1403-011



Denso
294200-0042
04226-0L020
294200-0040
294200-0093

Válvula dosificadora de caudal de bomba CR

**TOYOTA HILUX 2.5/3.0 VIGO/FORTUNER
PRADO 1KD/INNOVA COMMUTER 2KD FTV T25 2.0**

cm1403-012



Denso	Isuzu	Opel/GM
294200-3660	8-98043686-0	819185
294200-0660	8-98043686-1	
8171613043011	8-98043686-2	
DCRS300120	8-98043686-3	
John Deere	8-98043686-4	
DZ111135	8-98043686-5	
RE530337	8-98043686-6	
Re531864	8-98043686-7	
Mazda	8-98043686-8	
RFY2 13 Sm0	8-98043686-9	
Mitsubishi	Nissan	
1460A049	A6860-AW420	
	A6860-AW42B	

Válvula dosificadora de caudal de bomba CR

ISUZU ELF 400/450/500/600

cm1403-013



Denso
294200-2760
1460A056
2940200-2760
294200-4760
DCRS301700
SM294009-12904M
Isuzu
8-98145502-1

Válvula dosificadora de caudal de bomba CR

**ISUZU D-MAX 2.0 - MITSUBISHI L200 2.5 DI-D
NISSAN FRONTIER/NP300 YD25DDTI**

cm1403-014



Toyota
294200-0300
294200-03002F
294200-0301
Denso
97204-0300

Válvula dosificadora de caudal de bomba CR

TOYOTA HILUX 2.5/3.0

REPUESTOS

cm1220-997



Delphi Mercedes Benz
28342997 A6510700587
28297167 A6510704987
28348371 Infinity
Jeep 16600-HG00C
K6807217AA
K6817234AA

Inyector Common Rail

MERCEDES BENZ SPRINTER 411/415/515 OM651

cm1420-A041



Mitsubishi
1465A041
Denso
095000-5600
DCR1105600
095000-5601
095000-5602
095000-5603

Inyector Common Rail con código QR

MITSUBISHI L200 TRITON/MONTERO/CHALLENGER 4D56 EURO 4 2.5

cm1420-A054



Denso
095000-5760
095000-5761
Mitsubishi
1465A054

Inyector Common Rail con código QR

MITSUBISHI L200 / TRITON / MONTERO 3.2

cm1420-A307



Denso
095000-8110
Mitsubishi
1465A307

Inyector Common Rail con código QR

MITSUBISHI L200 / TRITON / MONTERO 3.2 4M40 / 4M41T

cm1420-A439



Denso
295050-1760
295050-1761
Mitsubishi
1465A439
1465A429

Inyector Common Rail con código QR

MITSUBISHI L200 / TRITON - FIAT FULLBACK 2,4 D

cm1420-0E010



Denso
295700-0550
296700-0160
296700-0150
296700-0520
Toyota
23670-0E010
23670-09420
23670-19015
23670-11010

Inyector Common Rail con código QR

TOYOTA FORTUNER/HILUX/LAND CRUISER 1GD 2,8

cm1420-0E020



Toyota
23670-0E020
23670-09430
23670-11020
23670-19025
Denso
295700-0560
295700-0090
295700-0120
295700-0530
295700-0560

Inyector Common Rail con código QR

TOYOTA HILUX / FORTUNER 2.4

cm1420-0E060



Denso
295700-1130
23670-08020
295700-11305G
295700-11306E
Toyota
23670-0E060
23670-09470

Inyector Common Rail con código QR - 6 Pines

TOYOTA HILUX 1GD 2.8

cm1420-0E070



Denso
23670-09460
295700-1140
Toyota
23670-0E070

Inyector Common Rail con código QR - 6 Pines

TOYOTA HILUX 2GD 2.4

cm1420-E0020



Denso
23670-E0020
23670-E0021
095000-6614
095000-6610
095000-6611
095000-6612
095000-6613
095000-0581
095000-0582

Inyector Common Rail

HINO 500 MOTOR J08E/J05E

cm1420-EB70A



Denso
095000-6250
095000-6251
095000-6252
095000-6253
Nissan
16600-EB70A
16600-EB70B
16600-EB70C

Inyector Common Rail con código QR

NISSAN FRONTIER/NAVARRA/PATHFINDER 2.5 YD25

cm1420-5X30A



Denso **Nissan**
295050-1050 16600-5X30A
295050-1051 16600-4KVOA
295050-1052 16600-5X300
295050-1053
295050-1054
295050-1055
295050-1056
295050-1057
295050-1058
295050-1059

Inyector Common Rail con código QR

NISSAN NAVARA/PATHFINDER/NP300 2.5

cm1420-010



Toyota
23670-0L010
23670-0P360
23670-0L070
23670-30300
23670-39255
23670-39275
Denso
095000-7761
095000-5520
095000-5930

Inyector Common Rail con código QR

TOYOTA HILUX/HIACE/VIGO 2.5

cm1420-050



Toyota
23670-0L050
23670-39216
23670-39186
23670-09330
Denso
095000-8290

Inyector Common Rail con código QR

TOYOTA HILUX 3.0

cm1420-090



Toyota
23670-0L090
23670-09350
Denso
295050-0520
295050-0180

Inyector Common Rail con código QR

TOYOTA HILUX 3.0 EURO 4

cm1420-110



Toyota
23670-0L110
23670-09380
23670-30420
Denso
295050-0810
295050-0800
295050-0620
095050-0540

Inyector Common Rail con código QR

TOYOTA HILUX/HIACE/DYNA 2.5

cm1420-118



John Deere
RE529118
RE546781
SE501926
RE524382
Denso
095000-6490
095000-6491
095000-6492

Inyector completo

JOHN DEERE 6068/4045

cm1420-0381



Chevrolet
12640381
Denso
295050-0960
095000-0960

Inyector Common Rail con código QR

CHEVROLET S10 2.8

REPUESTOS

cm1420-00613



Isuzu
8981600613
Denso
095000-8930
095000-8933
095000-6366
095000-6363
8976097880
8981600610

Injector Common Rail

ISUZU NKR/NPR/NQR 4HK1 5.2

cm1420-16041



Denso
095000-6980
095000-6981
095000-6982
095000-6983
095000-6984
095000-6985
095000-6986
095000-6100
Chevrolet
8980116041

Injector Common Rail con código QR

**CHEVROLET ISUZU/D-MAX
ISUZU ELF 300 3.0 4JJ1**

cm1420-50300



Chevrolet
8974350300
8981006932
8981066931
8981066930
Denso
095000-8341

Injector Common Rail con código QR

CHEVROLET ISUZU/D-MAX 3.0 4JJ1

cm1420-82473



Denso
295050-0930
295050-0933
Isuzu
8981782472
8981782473

Injector Common Rail

ISUZU NHR REWARD 4JH1 3.0

cm1420-97032



Chevrolet
8973297032
8973297031
8973297033
8973297034
8973297036
Denso
095000-5473
095000-2472
095000-5474

Injector Common Rail con código QR

CHEVROLET ISUZU ELF 400/ELF 450 5.2 - 4HK1/6HK1

cm1420-97886



Denso
095000-6360
095000-6361
095000-6362
095000-6363
Isuzu
8976097886
8976097887
8981600610
89760097882

Injector Common Rail

CHEVROLET NQR/NKR 4HK1/6HK1 5.2

dn23670-0L050



Denso
236700L050

Injector completo

TOYOTA HILUX 3.0

cm1520-1835



Scania
2031835
2086663
1881564

Injector DMB Cummins XPI

SCANIA D9 - D13

cm1520-2284



Scania
2872284
2872289
4955080

Injector DMB Cummins XPI

SCANIA D9 - D13

cm1520-2544



Scania
2872544

Injector Cummins XPI

SCANIA D9 - D13

cm1520-2544A



Scania
2872544

Injector original Cummins XPI

SCANIA D9 - D13

cm1520-7401



Scania
2057401

Injector DMB Cummins XPI

SCANIA D9 - D13

cm1520-7401A



Scania
2057401

Injector DMB Cummins XPI

SCANIA D9 - D13

cm1520-8244



Scania
2488244

Injector DMB Cummins XPI

SCANIA D9 - D13

cm2620-0R8473



Caterpillar
0R8473
1278213
1278216
1278209
1278222
1278209

Injector DMB con tobera 5 orificios

CATERPILLAR 3114/3116/3126

cm2620-4P2995



Caterpillar
4P2995 0R8467
1620218 0R8469
0R3006 0R8471
0R3389 7E5997
0R8461 7E6395
0R8465 7E8952

Injector DMB con tobera 6 orificios

CATERPILLAR 3114/3116/3126

dn1420-0E010



Denso
295700-0550
296700-0160
296700-0150
296700-0520
Toyota
23670-0E010
23670-09420
23670-19015
23670-11010

Injector Common Rail con código QR

TOYOTA FORTUNER/HILUX/LAND CRUISER 1GD 2,8

dn1420-0E020



Toyota
23670-0E020
23670-09430
23670-11020
23670-19025
Denso
295700-0560
295700-0090
295700-0120
295700-0530
295700-0560

Injector Common Rail con código QR

TOYOTA HILUX / FORTUNER 2.4

REPUESTOS

IN 154/110A



Mercedes Benz
A0060178421
Bosch
0432193436

Inyector DMB calibrado con tobera Bosch 0433175485 DSLA146P1730

MERCEDES BENZ OF 1722/1933/ATEGO/AXOR OM926 LA (EUROIII)

IN 154/110B



Mercedes Benz
A0060178621
Bosch
0432193481

Inyector DMB calibrado con tobera Bosch 0433175484 DSLA146P1729

MERCEDES BENZ OF 1218/1518 E3 OM904/OM906

IN 154/110C



Mercedes Benz
A0060179221
Bosch
0432193445

Inyector DMB calibrado con tobera Bosch 0433175483 DSLA146P1728

MERCEDES BENZ 2423 OM906 LA

IN 154/110D



Mercedes Benz
A0030100451
A0070170121
Bosch
0432193421
0432193416

Inyector DMB calibrado con tobera Bosch 0433175489 DSLA160P1786

MERCEDES BENZ ACCELO/AXOR/O500 OM924 LA ATEGO OM926 LA

IN 154/110E



Mercedes Benz
A0060171421
Bosch
0432193480

Inyector DMB calibrado con tobera Bosch 0433175416 DSLA156P1411

MERCEDES BENZ 915C/1117L/1317L/1517L/814L OM904/OM906

IN 154/110F



Mercedes Benz
A0060171521
Bosch
0432193481

Inyector DMB calibrado con tobera Bosch 0433175416 DSLA156P1411

MERCEDES BENZ ATEGO/AXOR/O500 OM906

IN 154/110G



Mercedes Benz
A0060177521
A0020109351
A0020107951
Bosch
0432193448

Inyector DMB calibrado con tobera Bosch 0433175478 DSLA153P1710

MERCEDES BENZ ATEGO/AXOR/O500 OM906

IN 154/118A



Mercedes Benz
A0020105051
A0060175121
A0070172321
Bosch
0432191258

Inyector DMB calibrado con tobera Bosch 0433171741 DLLA150P1164

MERCEDES BENZ ACTROS/AXOR/O500 OM457LA OM541 / OM542

IN 154/118B



Mercedes Benz
A0020104151
A0060174221
Bosch
0432191256

Inyector DMB calibrado con tobera Bosch 0433171741 DLLA160P1032

MERCEDES BENZ OM457

IN 154/118C



Mercedes Benz
A0030100551
Bosch
0432193419

Inyector DMB calibrado con tobera Bosch 0433175518 DSLA153P5518

MERCEDES BENZ ACTROS / AXOR OM457

IN 154/118G



Mercedes Benz
A0030100551
Bosch
0432193419

Inyector DMB calibrado con tobera Bosch 0433175518 DSLA153P5518

MERCEDES BENZ ACTROS / AXOR OM457

REPUESTOS

cm1322-P140



VDO
140PM0019

Tobera Common Rail - M0019P140

FORD RANGER MOTOR PUMA 3.2 TRANSIT MOTOR PUMA 2.2

cm1422-006



Inyectores
23670-0L090
23670-30400

Denso
G3S6

Tobera Common Rail

TOYOTA HILUX 3.0 - 3ERA GENERACIÓN

cm1422-007



Inyectores
23670/0L100

Denso
G3S7

Tobera Common Rail

TOYOTA HILUX 2.5 3ERA GENERACIÓN

cm1422-008



Inyectores
23670-0E020
295700-0560
23670-09430

Denso
G4S8
DLLA156G4S008

Tobera Common Rail

TOYOTA HILUX/FORTUNER 2.4

cm1422-009



Inyectores
23670-0E010

Denso
G4S009

Tobera Common Rail

TOYOTA HILUX 2017 2.8

cm1422-024



Inyectores
095000-7761
23670-30300
23670-0L070

Denso
093400-1024

Tobera Common Rail DSLA145P1024

TOYOTA HILUX 2.5

cm1422-033



Inyectores
23670-0L110
23670-30420

Denso
G3S33

Tobera Common Rail

TOYOTA HILUX 2.5

cm1422-048



Inyectores
295050-0930
8981782473
295050-0931
8981782472

Denso
G3S48
093400-0480

Tobera Common Rail

ISUZU NHR REWARD 4JH1 3.0

cm1422-050



Inyectores
295050-0960
12640381

Denso
G3S50

Tobera Common Rail

CHEVROLET S10 DURAMAX 2.8 L

cm1422-051



Denso
G3S51
293400-0510

Tobera Common Rail

NISSAN FRONTIER 2.5

cm1422-062



Denso
093400-1062

Tobera common rail - DLLA155P1062

TOYOTA HILUX 3.0

cm1422-077



Inyectores
295050-1760
1465A439

Denso
G3S77
293400-0770
DLLA148G3S77

Tobera common rail

**MITSUBISHI L200/TRITON
FIAT FULLBACK 2.4 D**

cm1422-096



Inyectores
095000-5471
095000-5361
095000-8901

Denso
093400-1096

Tobera Common Rail - DLLA158P1096

**CHEVROLET ISUZU ELF 400/450
5.2 - 4HK1/6HK1**

cm1422-320



Denso
093400-9320

Tobera common rail - DLLA148P932

NISSAN NP300

cm1422-470



Inyector
095000-6250

Denso
093400-9470

Tobera Common Rail DLLA152P947

CHEVROLET S10 - NISSAN

cm1422-480



Inyector
095000-6353

Denso
093400-8480

Tobera Common Rail DLLA155P848

NISSAN

cm1422-630



Inyectores
095000-5921
23670-0L020

Denso
093400-8630

Tobera Common Rail DLLA155P836

TOYOTA HILUX 3.0

cm1422-640



Inyectores
095000-5931
23670-0L010

Denso
G3S33

Tobera Common Rail

TOYOTA HILUX 2.5 3ERA GENERACIÓN

cm1422-700



Inyector
095000-5600

Denso
093400-8700

Tobera Common Rail DLLA145P870

MITSUBISHI L200 4D56

cm1422-720



Inyector
095000-5650

Denso
093400-8720

Tobera Common Rail DLLA148P872

NISSAN FRONTIER

cm1422-750



Denso
093400-8750

Tobera common rail DLLA148P875

MITSUBISHI L200 / PAJERO - 3,2 - 4M41

cm1422-800



Denso
093400-9800

Tobera common rail DLLA152P980

ISUZU RODEO / D-MAX - 4JJ1 3.0L

cm1422-890



Inyector
0950006480
0950006481

Denso
093400-8890

Tobera common rail DLLA125P889

JOHN DEERE 6090 9.0L

cm1522-2320



Inyector
2872544

Scania
P2872320

Tobera para inyector Cummins XPI

SCANIA D9 - D13

REPUESTOS

cm1522-2321



Inyector
2031835
2086663

Scania
P2872321

Tobera para inyector Cummins XPI

SCANIA D9 - D13

cm1522-4025



Inyector
2488244

Scania
P4384025

Tobera para inyector Cummins XPI

SCANIA D9 - D13

cm1522-4708



Inyector
2872405

Scania
P4954708

Tobera para inyector Cummins XPI

SCANIA D9 - D13

cm1522-7083



Cummins
P4307083FSW
Foton
1T18011-1400
1T21082-3948

Tobera DMB

FOTON CUMMINS ISG 11.8L

cm1522-7551



Inyector
2057401

Scania
P2897551

Tobera para inyector Cummins XPI

SCANIA D9 - D13

REPUESTOS

cm1425-001

Válvula plaqueta para inyector

TOYOTA - DENSO

cm1425-004



Inyectores
23670-0E020
23670-0E010

Denso
G4
295040-9440

Válvula plaqueta de inyector
**TOYOTA HILUX/FORTUNER 2.4
HILUX 2.8**

cm1425-005



Inyectores
095000-8290 095000-5160
095000-5050 095000-5190
095000-5150 095000-5230

Denso
ND5051-5

Válvula plaqueta de inyector Common Rail

TOYOTA HILUX 3.0 - DESPIECE

cm1425-005A



Válvula plaqueta para inyector

TOYOTA HILUX 2.5 - DENSO

cm1425-006



Inyectores
23670-0L090/23670-30400
095000-1440/295050-0520
295040-6280

Denso
#507
KS11

Válvula plaqueta de inyector

TOYOTA HILUX 3.0

cm1425-009



Inyectores
095000-5086 095000-5810
095000-5550 095000-7731
095000-5801 095000-7761

Denso
ND5051-9

Válvula plaqueta de inyector Common Rail

TOYOTA HILUX 2.5 - DESPIECE

cm1425-009A

Válvula plaqueta para inyector

TOYOTA HILUX 3.0 - DENSO

cm1425-012

Válvula plaqueta para inyector

NIPON DENSO

cm1425-019



Inyectores
095000-8900
095000-8901

Denso
#19

Válvula plaqueta de inyector
**CHEVROLET ISUZU ELF 400 /ELF 450
5.2 - 4HK1/6HK1**

REPUESTOS

cm1425-033



Inyectores
23670-0L110
23670-30420

Denso
#SF03

Válvula plaqueta de inyector
TOYOTA HILUX 2.5

cm1425-077



Inyectores
295050-1760
1465A439

Denso
#10
295040-6280
295040-6290

Válvula plaqueta de inyector
MITSUBISHI L200/TRITON
FIAT FULLBACK 2,4 D

cm1425-088



Plaqueta inyector
TOYOTA COROLLA

cm1425-509



Inyectores
295050-0930/8981782473
295050-0931/8981782472

Denso
#509

Válvula plaqueta de inyector
ISUZU NHR REWARD 4JH1 3.0

cm1444-0281



Denso
095420-0281
095420-0260

Válvula limitadora de presión de combustible para riel
NISSAN NP300 - MITSUBISHI L200 - HYUNDAI HD78
ISUZU D-MAX - JOHN DEERE

cm1444-0670



Bosch Denso
095420-0670
095420-0280

Válvula limitadora de combustible para riel
TOYOTA PRADO/HIACE/HILUX

REPUESTOS

cm1521-2820



Scania
1932820
1933246
1889112
1794862

Kit de reparación externa DMB para inyector - O-rings de vitón
SCANIA R450/R550 DC09 / DC13 / DC16 CUMMINS ISX15
P/G/R/T - VOLVO - NAVISTAR

cm1521-4811



Scania
5314811 kit

Kit válvula DMB 5314811 y o-rings para inyector XPI

SCANIA D9 - D13

cm1525-4811



Scania
5314811

Válvula DMB para inyector Cummins XPI

SCANIA D9 - D13

REPUESTOS

cm2171-001



Bosch
960040312

Kit inyector bomba Bosch

IVECO CURSOR 10-13 430CV

cm2171-002



Kit de o-rings externo

MERCEDES BENZ

cm2171-003



Kit de o-rings externo

MERCEDES BENZ

cm2171-004

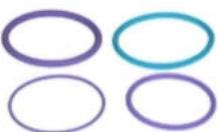

Kit de o-rings externo Bosch

VOLVO

cm2171-005



Kit de o-rings externo

BOSCH

Bosch
F00VX99992
Volvo
FH12460HP

cm2171-006



Kit de o-rings externo

SCANIA - BOSCH

REPUESTOS

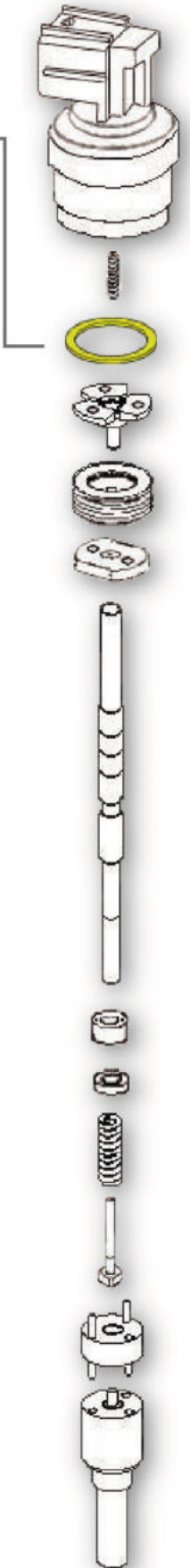
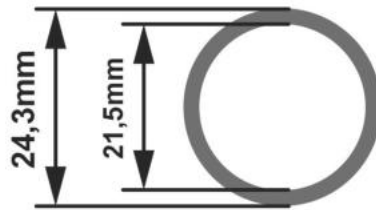

	cm1426-A153A162	
	GROSOR	CANTIDAD
cm1426-A153	1.53	5
cm1426-A154	1.54	5
cm1426-A155	1.55	5
cm1426-A156	1.56	5
cm1426-A157	1.57	5
cm1426-A158	1.58	5
cm1426-A159	1.59	5
cm1426-A160	1.60	5
cm1426-A161	1.61	5
cm1426-A162	1.62	5
	CANTIDAD BOX: 50	

	cm1426-A163A172	
	GROSOR	CANTIDAD
cm1426-A163	1.63	5
cm1426-A164	1.64	5
cm1426-A165	1.65	5
cm1426-A166	1.66	5
cm1426-A167	1.67	5
cm1426-A168	1.68	5
cm1426-A169	1.69	5
cm1426-A170	1.70	5
cm1426-A171	1.71	5
cm1426-A172	1.72	5
	CANTIDAD BOX: 50	



REPUESTOS

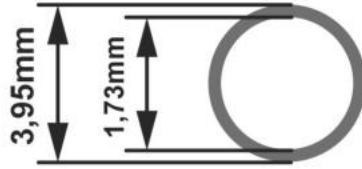

cm1426-B112B130		
	GROSOR	CANTIDAD
cm1426-B112	1.12	5
cm1426-B114	1.14	5
cm1426-B116	1.16	5
cm1426-B118	1.18	5
cm1426-B120	1.20	5
cm1426-B122	1.22	5
cm1426-B124	1.24	5
cm1426-B126	1.26	5
cm1426-B128	1.28	5
cm1426-B130	1.30	5
CANTIDAD BOX: 50		

cm1426-B132B150		
	GROSOR	CANTIDAD
cm1426-B132	1.32	5
cm1426-B134	1.34	5
cm1426-B136	1.36	5
cm1426-B138	1.38	5
cm1426-B140	1.40	5
cm1426-B142	1.42	5
cm1426-B144	1.44	5
cm1426-B146	1.46	5
cm1426-B148	1.48	5
cm1426-B150	1.50	5
CANTIDAD BOX: 50		



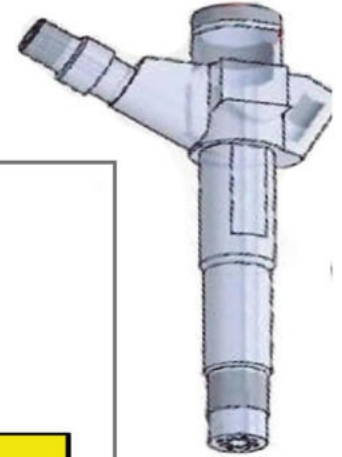
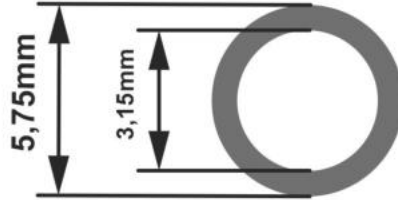

	cm1426-C100C145	
	GROSOR	CANTIDAD
cm1426-C100	1.00	5
cm1426-C105	1.05	5
cm1426-C110	1.10	5
cm1426-C115	1.15	5
cm1426-C120	1.20	5
cm1426-C125	1.25	5
cm1426-C130	1.30	5
cm1426-C135	1.35	5
cm1426-C140	1.40	5
cm1426-C145	1.45	5
	CANTIDAD BOX: 50	

	cm1426-C150C195	
	GROSOR	CANTIDAD
cm1426-C150	1.50	5
cm1426-C155	1.55	5
cm1426-C160	1.60	5
cm1426-C165	1.65	5
cm1426-C170	1.70	5
cm1426-C175	1.75	5
cm1426-C180	1.80	5
cm1426-C185	1.85	5
cm1426-C190	1.90	5
cm1426-C195	1.95	5
	CANTIDAD BOX: 50	



REPUESTOS

cm2171-007



Kit de o'rings externo

DELPHI

cm2171-008



Kit de o'rings externo

SCANIA - IVECO - BOSCH

Scania
1440576
Iveco
500379769
Bosch
F00VX99995

cm2171-009



Kit de o'rings externo

IVECO - BOSCH

Iveco
500350189
Bosch
F00VX99996

cm2171-010



Kit de o'rings

BOSCH

Scania
1731209
1728288
Bosch
F00HN37925
F00HN37928

cm2171-011



Kit de o'rings

VOLKSWAGEN - BOSCH

cm2171-012



Kit de o'rings para solenoides

SCANIA - BOSCH

cm2171-013



Kit de o'rings para solenoides

BOSCH

cm2171-014



Kit de o'rings para solenoide

VOLKSWAGEN - BOSCH

cm2171-015



Kit de 6 o'rings para inyectores

CUMMINS
0445120007 / 0445120120 / 0445120140

Bosch
2430210081

cm2171-016

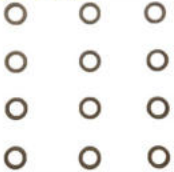

Kit de 12 orings para canula entre tubo inyector e inyector

MERCEDES BENZ OM904/OM906/OM457
CUMMINS - IVECO

Bosch
2430210082
Mercedes Benz
A5419970645

cm2171-017



Kit de 12 o'rings para inyectores

VOLKSWAGEN - BOSCH

cm2171-018

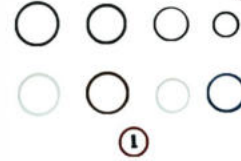

Kit de o'rings para inyector mas solenoide

SCANIA - IVECO - VOLVO

cm2171-019



Kit de o'rings y pernos

BOSCH PDE100

Bosch
F00HN37972

cm2171-020

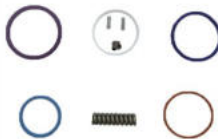

Kit para Scania

SCANIA - BOSCH PDE90/PDE100

Bosch
F00HN37912
Scania
1541175

cm2171-021

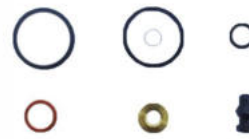

Juego de juntas

BOSCH PDE75/PDE80

Bosch
1417010997

cm2171-022

Ø 1.5 x 17mm



Kit de pernos para alineación (Contiene 10 piezas)

BOSCH

cm2171-023

Ø 1.8 x 17mm



Kit de pernos para alineación (Contiene 10 piezas)

BOSCH

cm2171-024

Ø 1.5 x 24mm



Kit de pernos para alineación (Contiene 10 piezas)

BOSCH PDE80

REPUESTOS

cm2171-025



Bosch
1417010996
Volkswagen
03G198051

Kit para Volkswagen

BOSCH PDE80

cm2171-026



Bosch
F00HN37070
Mercedes Benz
0120740101

Kit para Mercedes Benz Atego

BOSCH 110/DPE110

cm2171-027

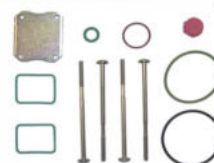

Bosch
F00HN37069

Kit de reparación Mercedes Benz

MERCEDES BENZ PLD/ATEGO/AXOR
OM904

cm2171-028



Kit de oring's y arandelas planas para 6 inyectores

MERCEDES BENZ OM906/OM926

cm2171-029



Kit de oring's y arandelas bujes para 6 inyectores

MERCEDES BENZ OM906/OM926

cm2171-030



Kit de oring's y arandelas planas para 4 inyectores

MERCEDES BENZ OM904/OM924

cm2171-031



Kit de oring's y arandelas bujes para 4 inyectores

MERCEDES BENZ OM904/OM924

cm2271-001



Bosch
F00HN37925

Kit de o-ring para inyector más solenoide

IVECO CURSOR 8 / CURSOR13
VOLVO

REPUESTOS

cm3122-416



Inyectores
0432193480 A0060171521
0432193481 A0060171421

Bosch
0433175416
Mercedes Benz
A0060171421

Tobera DMB DSLA156P1411

MERCEDES BENZ 915/1117L/1317L/1517L
OM904/906

cm3122-483



Inyectores
0432193445
A0000789223

Bosch
0433175483
Mercedes Benz
A0000789223

Tobera DMB DSLA150P1728

MERCEDES BENZ ACCELO 2006 OM904
ATEGO 2000-2006 OM906LA

cm3122-484



Inyectores
0432193442
A0000789323

Bosch
A0000789323
Mercedes Benz
0433175484

Tobera DMB DSLA150P1729

MERCEDES BENZ ATEGO/OH1518 TRUCK
OM904/906 4.3

cm3122-485



Inyectores
0432193436
0432193437

Bosch
0433175485
Mercedes Benz
A0000789423

Tobera DMB DSLA146P1730

MERCEDES BENZ OM924/926

cm3122-489



Inyectores
0432291657
0432291658

Bosch
0433175489
Mercedes Benz
A0000789623

Tobera DMB DSLA160P1786

MERCEDES BENZ OM924/926

REPUESTOS

cm2172-6995

 Circunferencia
6,995

Pistón de válvula para inyector bomba PDE Bosch

VS
cm2172-7000

 Circunferencia
7,000

Pistón de válvula para inyector bomba PDE Bosch

VS
cm2172-7005

 Circunferencia
7,005

Pistón de válvula para inyector bomba PDE Bosch

VS
cm2172-7010

 Circunferencia
7,010

Pistón de válvula para inyector bomba PDE Bosch

VS
cm2172-7015

 Circunferencia
7,015

Pistón de válvula para inyector bomba PDE Bosch

VS
cm3182-6995

 Circunferencia
6,995

Pistón de válvula para monobomba PLD Bosch

VS
cm3182-7000

 Circunferencia
7,000

Pistón de válvula para monobomba PLD Bosch

VS
cm3182-7005

 Circunferencia
7,005

Pistón de válvula para monobomba PLD Bosch

VS
cm3182-7010

 Circunferencia
7,010

Pistón de válvula para monobomba PLD Bosch

VS
cm3182-7015

 Circunferencia
7,015

Pistón de válvula para monobomba PLD Bosch

VS

REPUESTOS

cm1521-2820

Scania
1932820
1933246
1889112
1794862

 Kit de reparación externa DMB para inyector XPI ISX
SCANIA R450/R550 - DC09/DC13/DC16 - P/G/R/T
CUMMINS ISX15

cm2571-1237

Scania
1441237

 Kit de reparación DMB para inyector HPI
SCANIA DC12/DT12 - VOLVO - NAVISTAR
CUMMINS ISX/QSX

cm2571-1240

 Kit espiga y retén para inyector HPI
SCANIA DC12/DT12 - VOLVO - NAVISTAR
CUMMINS ISX/QSX

REPUESTOS

AC 115/505



Cummins
4307148

Arandela para inyector HPI
SCANIA DC12/DT12 - VOLVO - NAVISTAR
CUMMINS ISX/QSX

AC 115/506



Arandela de cobre externa de asiento de inyector XPI
SCANIA R450/R550 - DC09/DC13/DC16 - P/G/R/T
CUMMINS ISX15

E 146/101



Espiga para inyector HPI
SCANIA DC12/DT12 - VOLVO - NAVISTAR
CUMMINS ISX/QSX

FM 152/101



Scania
1421174
ED3087316
Cummins
3348004

Filtro blanco DMB para inyector HPI
SCANIA DC12/DT12 - VOLVO - NAVISTAR
CUMMINS ISX/QSX

FM 152/102



Scania
1434707
Cummins
4006962

Filtro negro DMB para inyector HPI
SCANIA DC12/DT12 - VOLVO - NAVISTAR
CUMMINS ISX/QSX

REL 185/101



Scania
1801481

Retén para inyector HPI
SCANIA DC12/DT12 - VOLVO - NAVISTAR
CUMMINS ISX/QSX

cm2571-1245



FM 152/101

Cód. Originales
Scania
1421174
ED3087316
Cummins
3348004



FM 152/102

Cód. Originales
Scania
1434707
Cummins
4006962



cm2571-1237

Código original kit Scania
1441237

Cód. Originales
Cummins

1- 3867654 (Negro)
2- 4010577 (Verde)
3- 4307148 (Arandela)
4- 3347939 (Amarillo)
5- 3347937 (Violeta)



cm2571-1240

Kit completo o'rings, arandela, espiga, retén y filtros para inyector ISX/QSX sistema HPI

SCANIA DC12/DT12 - VOLVO - NAVISTAR

REPUESTOS

cm3181-002

Juego de piezas Bosch PLD

RENAULT

cm3181-004



Tornillos

VS

cm3199-002A

Cánula inyector

MERCEDES BENZ OM904

cm3199-002



Bosch
2433370467
Mercedes Benz
A5410170324
A9060170521
A9060170524
A9060170324

Cánula inyector (PLD)

MERCEDES BENZ OM904/906/924/926

REPUESTOS

cm4199-001



Junta con forma EDC

VS

cm4199-003

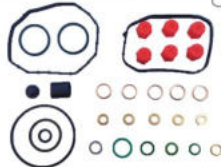

Juegos de Juntas bombas VE con regulador electrónico EDC

MERCEDES BENZ OM904

Bosch
2467010003

cm4199-004



Juego de juntas Bosch con EDC - VP44
RENAULT - FIAT - VOLKSWAGEN
CHEVROLET - FORD

Bosch
1467045046

REPUESTOS

cm4299-001



Lucas Delphi
9108-154B
Renault
7701044974

Electroválvula de avance 12 V tipo CAV DPCN

FIAT - IVECO

cm4299-005



Lucas Delphi
9100-898B

Electroválvula de avance 12 V - Actuador

FORD MONDEO/ESCORT/ORION

cm4299-006



Lucas Delphi
9100-827F

Electroválvula de avance 12 V - Actuador

VOLKSWAGEN SKODA/SKODA TDI

REPUESTOS

AC 112/50



Bosch
2 430 105 049
Mercedes Benz
906 017 02 60

De cobre

MERCEDES BENZ OM 904 - 906 ELECTRONICO
OM 457 ELECTRONICO

AC 112/54



Bosch
F 00Z W00 003
Mercedes Benz
906 017 08 60

Arandela Buje

MERCEDES BENZ OM 904 /906 / 457
ELECTRÓNICO

AC 112/54A



Asiento inyector

NAVISTAR ELECTRONICO

AC 112/61

7.3 x 14.8 x 3



Cod.Orig.
7703062072

De cobre

RENAULT SANDERO / CLIO II / MEGANE II
LAGUNA II / LOGAN - MOTOR K9K

AC 112/66

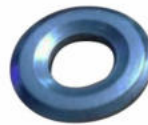

Toyota
11176-0L011
11176-30011

De hierro biselada

TOYOTA HILUX COMMON RAIL 3.0 / 2.5

AC 112/67



Toyota
11176-0E010

De hierro biselada

TOYOTA HILUX COMMON RAIL 2.4 / 2.8

AH 112/68



Arandela de hierro biselada asiento inyector Common Rail

TOYOTA COROLLA 2.0 D4D

AC 115/97

8 x 13 x 1



Arandela doble retorno Common Rail Hilux 1-2KDFTV

TOYOTA

Toyota
90904-30013
90430-T0008

AC 115/100

6 mm Doble



De cobre doble de retorno

TOYOTA HILUX 2.4/2.8 - 1GDFTV/2GDFTV

Toyota
90430-T0017

AL 115/101 14 mm Doble

Toyota
90430-T0017

Arandela de aluminio doble de 14 mm para inyector DPF filtro de partículas (5to inyector)

TOYOTA HILUX SW4 2.8 1GDFTV / 2.4 2GDFTV

VS

AH 115/501 5 x 10 x 1

Bosch
F00VC17002
F00VC17003

De hierro

VS

AH 115/502 8 x 10 x 0.6 (e=0.2m)

Bosch
F00VC17105

De hierro

VS

AF 115/503

Bosch
F00VC04049

Arandela especial de PTFE + Bronce

VS

AC 115/504 9.5 x 20 x 1

De cobre

CAMIÓN RENAULT 420/370 DCI

AC 115/505

Cummins
4307148

Arandela para inyector HPI

**SCANIA DC12/DT12 - VOLVO - NAVISTAR
CUMMINS ISX/QSX**

AC 115/506

Arandela de cobre externa de asiento de inyector

**SCANIA DC12/DT12 - VOLVO - NAVISTAR
CUMMINS ISX/QSX**

AG 122/600

Para inyector de bomba sistema PDE - de vitón

SCANIA SERIE 4

AG 122/601

Para inyector de bomba sistema PDE - de vitón

SCANIA SERIE 4

AG 122/602

Para inyector de bomba sistema PDE - de vitón

SCANIA SERIE 4

AG 122/603

Bosch
2430210081

Oring viton para iny. elect.

CUMMINS
0445120007 / 0445120120 / 0445120140

AG 122/604

Bosch
F00VC38002

Oring de grupo magnetico inyectores BOSCH CRI Common Rail

VS

AG 122/605

Para monobomba Bosch - Sistema PLD

MERCEDES BENZ OM 904/906 ELECTR.

AG 122/606

Para monobomba Bosch - Sistema PLD

MERCEDES BENZ OM904/906 ELECTR.

AG 122/607

Bosch
2430210082
Mercedes Benz
A5419970645

Oring viton para canula entre tubo inyector e inyector

**MERCEDES BENZ OM904/OM906/OM457
CUMMINS - IVECO**

AG 122/608

Bosch
A5419970545

Oring viton para iny. mecan.

**MERCEDES BENZ
OM904/OM906/OM457 0432193480**

AG 122/609

Bosch
F00HN35985

De perno externo monobomba PLD

MERCEDES BENZ OM904/924/925/926

AG 122/610

Bosch
F00RJ01878

Para inyector Bosch electrónico

CAMIÓN RENAULT 420/370 DCI

AG 122/611



Bosch
F00VD38010

Para válvula reguladora de presión tipo Bosch

RENAULT - CITROEN - PEUGEOT

AG 122/613



O'ring externo de cuerpo de inyector Denso Common Rail

TOYOTA - NISSAN - MITSUBISHI

AG 122/616



Mercedes Benz
A0239976548
Bosch
F00HN35933
DAF: 1351366
Deutz: 4261417

O ring externo para monobomba Bosch OM457

MERCEDES BENZ AXOR MOTOR OM457LA
ACTROS MOTOR OM451

AG 122/617



Mercedes Benz
A0239976448
Bosch
F00HN35932
DAF: 1351365
Deutz: 4261416

O ring externo para monobomba Bosch OM457

MERCEDES BENZ AXOR MOTOR OM457LA
ACTROS MOTOR OM451

AG 122/619



Bosch
F00RJ00220

O'ring de inducido para inyector

IVECO EUROCARGO MOTOR CUMMINS

AG 122/620



Bosch
F00RJ00534
MAN
51965010541

O'ring para cierre caperuza inyector CRIN

MAN

BA 128/5

∅ 1,34mm



Bosch
F00VC05001

Para valvula de inyector Bosch electronico (todos)

TODOS C/INYECTOR BOSCH

BA 128/6

∅ 1,50mm



Bosch
F00VC05006

Para valvula de inyector Bosch electronico (todos)

TODOS C/INYECTOR BOSCH

BA 130/213B



Bosch
0440020101
Fiat
8097766

Bomba de combustible

IVECO - NEW HOLLAND - VOLKSWAGEN

CP 134/26



Protector para enchufe de inyector electrónico y bomba de alta presión

VS

CP 134/27



Protector para inyector Delphi electrónico

VS

CP 134/28



Protector para inyector electrónico

VS

E 146/101



Espiga para inyector HPI
SCANIA DC12/DT12 - NAVISTAR
VOLVO CUMMINS ISX/QSX

FM 152/101



Scania
1421174
ED3087316
Cummins
3348004

Filtro blanco DMB para inyector HPI
SCANIA DC12/DT12 - VOLVO - NAVISTAR
CUMMINS ISX/QSX

FM 152/102



Scania
1434707
Cummins
4006962

Filtro negro DMB para inyector HPI
SCANIA DC12/DT12 - VOLVO - NAVISTAR
CUMMINS ISX/QSX

JR 155/110



Para inyectores
Bosch
Denso
Siemens

Ref. 1 CP 134/28
Ref. 2 CP 134/26
Ref. 3 CP 134/1A
Ref. 4 CP 134/18

Kit de protectores plásticos para inyectores electrónicos

VS

JR 155/115



Ref. 1 AC 115/504
Ref. 2 AG 122/610

Kit de arandela + O'ring para inyector Bosch Common Rail

CAMIÓN RENAULT 420/370 DCI

JR 155/113



Ref. 1- AH 115/501
Ref. 2- AH 115/502
Ref. 3- AF 115/503
Ref. 4- AG 122/604
Ref. 5- BA 128/5
Ref. 6- CP 134/1A
Ref. 7- CP 134/17
Ref. 8- CP 134/28

Kit para inyector Common Rail con bolilla de acero de 1.34mm

VS

REPUESTOS

JR 155/113B



Ref. 1- AH 115/501
Ref. 2- AH 115/502
Ref. 3- AF 115/503
Ref. 4- BA 128/5

Kit para inyector Common Rail con bolilla de acero de 1.34mm sin tapones, sin oring

VS

JR 155/113C



Ref. 1- AH 115/502
Ref. 2- AF 115/503
Ref. 3- BA 128/5

Kit para inyector Common Rail - 2 Arandelas + Bolilla

VS

JR 155/113D



Ref. 1- AF 115/503
Ref. 2- AG 122/604
Ref. 3- AH 115/501
Ref. 4- AH 115/502
Ref. 5- BA 128/6

Kit para inyector Common Rail con bolilla de acero de 1,5mm sin tapones

VS

JR 155/114



Ref. 1- AH 115/502
Ref. 2- AF 115/503

Bosch
F00VC99002

Kit de arandelas para inyector Bosch Common Rail

VS

JR 155/311AG

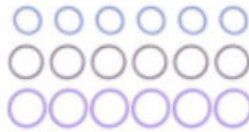

Scania
1422564
Bosch
F00VX99999

Kits de O'ring para inyector bomba sistema PDE

SCANIA SERIE 4

JR 155/312AG



Mercedes Benz
A0289975648
Bosch
F00HN37454

Kit de O' rings para monobomba Bosch sistema PLD

MERCEDES BENZ OM904/906 ELECTRÓNICO

PT 170/66



Bosch
2 433 349 503

Portatobera para inyector 0432191488/493/503/523
MERCEDES BENZ OM447/449/1938 "EDC"
160P577

PT 170/71



Bosch
2 433 349 189

Portatobera
MERCEDES BENZ OM904/906
712 / 1115 ELECTRONICO - 156P1411

PT 170/88



Portatobera
FORD RANGER 3.0 ELECTRONICO
TOBERA M1600P150782

PT 170/95



Portatobera
FORD FOCUS C/INYECTOR DELPHI 2701
PARA TOBERA 140P640

PT 170/96



Portatobera
FOCUS DELPHI ELECTRONICO
TOBERA L12PBD A 1601

PT 170/97



Portatobera
RENAULT CLIO
DELPHI ELECTRONICO

PT 170/100



Portatobera
CITROËN C3 C/TOBERA PM0604 / FORD FIESTA - ECOSPORT
C/TOBERA PV0605 (INYECTOR SIEMENS)

PT 170/102



Bosch
1 410 497 042

Portatobera
VOLKSWAGEN
KIT PDE VW BORA 1.9 TDI C/MOTOR BEW (DSL150P1362)
KIT PDE VW BORA / PASSAT 1.9 TDI C/MOTOR AVF/AWX (DSL150P1248)
KIT PDE BORA C/MOT.AXR/GLOF 1.9 TDI / PASSAT (DSL150P1247)
KIT PDE BORA / GOLF 1.9 TDI ASZ / ARL (DSL150P1043)

REL 185/101



Scania
1801481

Retén para inyector HPI
SCANIA DC12/DT12 - VOLVO - NAVISTAR
CUMMINS ISX/QSX

SV 190/31



Bosch
F 00V C22 003
Peugeot
198270

Seguro de sujeción para retorno de inyectores

PEUGEOT HDI

SV 190/32



Siemens
X11-800-001-002Z

Seguro de sujeción para inyectores Siemens

VS

im CR6 500 AE Tubería de banco de prueba de 6x2 Largo 500 mm - Tuercas A y de 16 x 1,5

im CR6 500 BE Tubería de banco de prueba de 6x2 Largo 500 mm - Tuercas B y de 16 x 1,5

im CR6 800 AE Tubería de banco de prueba de 6x2 Largo 800 mm - Tuercas A y de 16 x 1,5

im CR6 800 BE Tubería de banco de prueba de 6x2 Largo 800 mm - Tuercas B y de 16 x 1,5

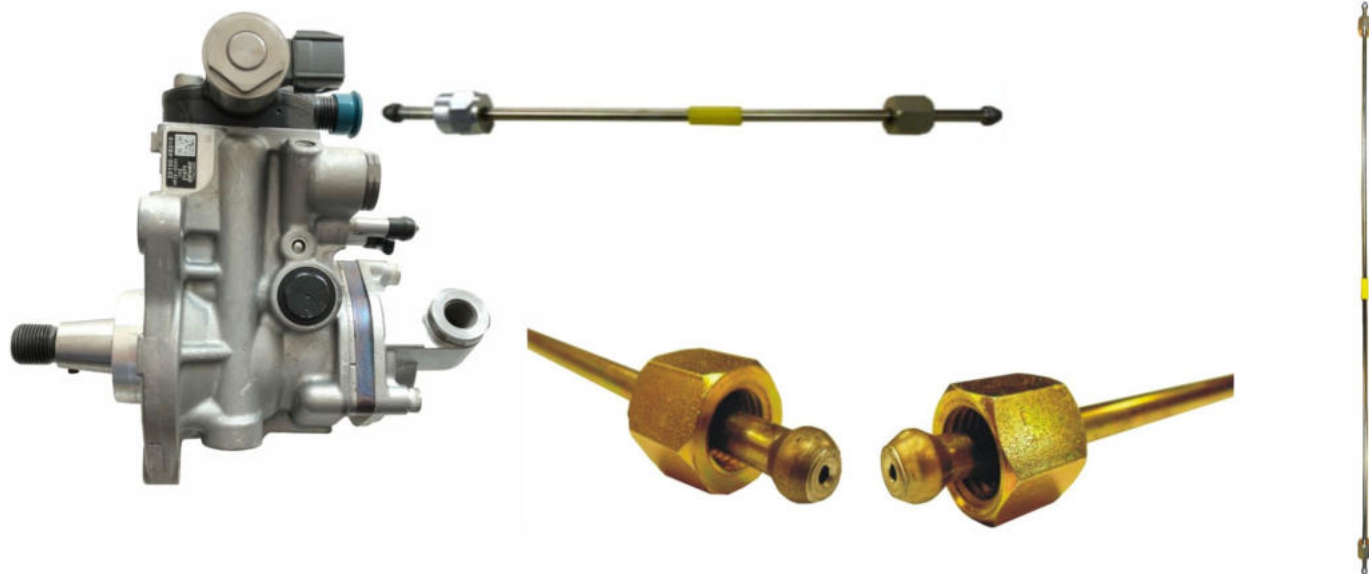

Tubería de banco de prueba para Common Rail de rampa a bomba

TOYOTA HILUX 2.4 Y 2.8 PARA BOMBA 22100-0E010

im CR6 400 AD Tubería de banco de prueba de 6x2 Largo 400 mm - Tuercas A y de 16 x 1

im CR6 500 AD Tubería de banco de prueba de 6x2 Largo 500 mm - Tuercas A y de 16 x 1

im CR6 600 AD Tubería de banco de prueba de 6x2 Largo 600 mm - Tuercas A y de 16 x 1

im CR6 700 AD Tubería de banco de prueba de 6x2 Largo 700 mm - Tuercas A y de 16 x 1

im CR6 800 AD Tubería de banco de prueba de 6x2 Largo 800 mm - Tuercas A y de 16 x 1

im CR6 900 AD Tubería de banco de prueba de 6x2 Largo 900 mm - Tuercas A y de 16 x 1

im CR6 1000 AD Tubería de banco de prueba de 6x2 Largo 1000 mm - Tuercas A y de 16 x 1



Tubería de banco de prueba para Common Rail de rampa a bomba

VOLKSWAGEN AMAROK

NLE 8

Tubería de inyección Common Rail de bomba a flauta
FORD FOCUS 1.8 TDCI

NL FT 9

Conjunto de 4 Tuberías de Inyección
FIAT STRADA/PUNTO 1.3 JTD MULTIJET 16V

NLF 31



Iveco
 504023112,
 504091537

Tubería de inyección de bomba a rampa - Common Rail
**IVECO EURO CARGO 150E28W/160E30/180E30 EURO 4 / TECTOR 170E22
 170E28/170E30/240E22/240E28/260E28, TRAKKER 380T50**

NLF 32

Iveco
 504333692

Tubería de inyección de bomba a rampa
**CASE / NEW HOLLAND MAGNUM, STEIGER
 IVECO 3.2 - F2CFE613 / F2CFE614**

NLG 6



Volkswagen
 03L130321N

Tubo de alta presión de bomba a rampa
VOLKSWAGEN AMAROK/TIGUAN/PASSAT 2.0 TDI

NLG 7



Conjunto de 4 Tuberías de Inyección
VOLKSWAGEN AMAROK/TIGUAN/PASSAT

NLG 8



Volkswagen
 03L130321Q

Tubo de alta presión de bomba a rampa
**VOLKSWAGEN AMAROK/TIGUAN 2012 EN ADELANTE
 MOTOR 2.0 - CNFA/CNEA/CSHA**

NLM 31



Mercedes Benz
 A6110701433

Tubo de alta presión de bomba de alta presión a rail
MERCEDES BENZ SPRINTER 313 OM611

REPUESTOS

NL M 32

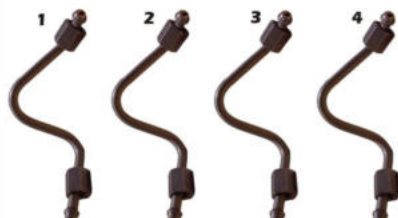

Mercedes Benz
A6110700033

Juego de 4 tubos de inyección de rampa (Riel) a inyector

MERCEDES BENZ SPRINTER 3/T 313 CDI OM611LA

NL T 3



Juego de 4 tuberías de inyección

TOYOTA HILUX 2.5 Y 3.0 ELECTRÓNICO

NL TF 9



Conjunto de 4 tuberías de Inyección - Tubo alta presión de rampa (Riel) a inyector

RENAULT CLIO II/MEGANE II/LOGAN/SANDERO MOTOR K9K

NL TF 10



Tubo de alta presión de bomba a rampa (Riel)

RENAULT CLIO II/MEGANE II/LOGAN/SANDERO MOTOR K9K

NL U 11

Salida bomba: Tuerca 14x1,5 mm
Salida inyector: Tuerca 14x1,5mm



Conjunto de 6 tuberías de inyección

MICRO OA 101

NL U 12

Salida bomba: Tuerca 12x1,5 mm
Salida inyector: Tuerca 14x1,5mm



Cummins	Ford	Volkswagen
1) 3356504	1) BF8X9A555AA	1) ZSO130301
2) 3934181	2) BF8X9A556AA	2) ZSO130302
3) 3934183	3) BF8X9A557AA	3) ZSO130303
4) 3356509	4) BF8X9A558AA	4) ZSO130304
5) 3356507	5) BF8X9A559AA	5) ZSO130305
6) 3356508	6) BF8X9A560AA	6) ZSO130306

Conjunto de 6 tuberías de inyección - Bomba rotativa

FORD 14000 (160 HP) / CARGO 1215/1415/1617 - VOLKSWAGEN 17220/17300 24200/16170/12170/14170/13170/15170/17210 - CUMMINS 6BT 5.9

NL U 13

Salida bomba: Tuerca 14x1,5 mm
Salida inyector: Tuerca 12x1,5mm



COSECHADORA CASE MW (1 TUERCA B "BOMBA" Y 1 TUERCA A "INYECTOR") - CUMMINS 6CTA 8.3

U 26

Salida bomba e inyector
14 x 1.5 mm



Cummins

- 1) 3965964
- 2) 2831356
- 3) 2830621
- 4) 2831356
- 5) 2830621
- 6) 3968346

Ford

- 1) BG5X 9A555BA
- 2y4) BG5X 9A556BA
- 3y5) BG5X 9A557AA
- 6) BG5X 9A558AA

Tubería de inyección de rampa a inyector Common Rail

FORD CARGO 1317 / 1722 / 2428 - VOLKSWAGEN 8150 / 9150 / 15170 / 17250 MOTOR CUMMINS ISBE6 - MOTOR 5.9

REPUESTOS

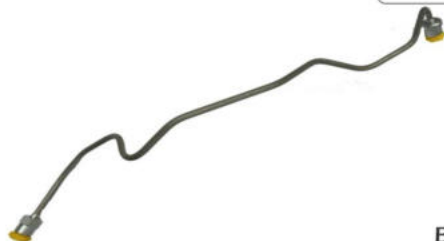
U 27Salida bomba e inyector
14 x 1.5 mm**Cummins**
3287880
Ford
BG5X9C520GA

Tubería de inyección de bomba a rampa Common Rail

FORD - 1722 E / VOLKSWAGEN - 17250
MOTOR CUMMINS ISBE6**U 28****Cummins**
1) 3965964
2) 2831356
3) 4991546
4) 2830621
5) 4991546
6) 3968346

Tubería de inyección de rampa a inyector Common Rail

CUMMINS ISBE6 2010 EN ADELANTE